

**Pressure Transmitter  
with current output (2-wire)  
PT5000PSIG-13-LI3-H1131**

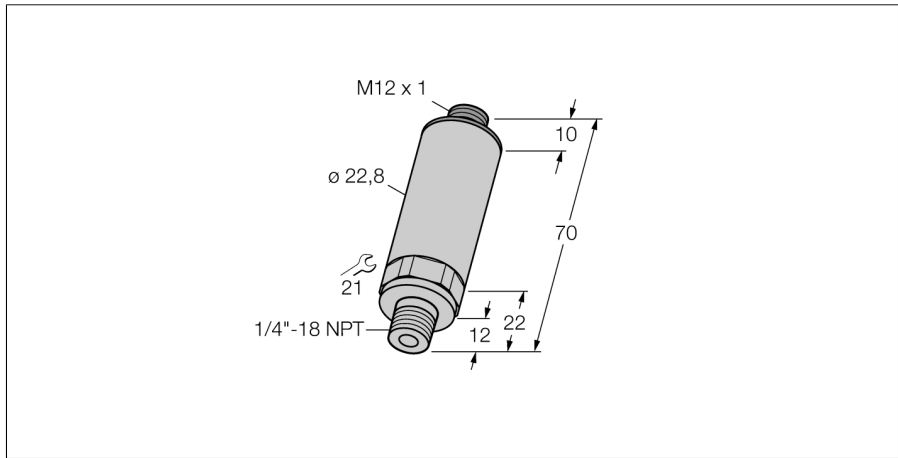

- Compact and robust design
- Pressure connection with integrated peak pressure aperture
- Minimum influence of temperature on accuracy within the entire temperature range of -40...+125°C
- Excellent EMC properties
- Pressure range 0...5000 psi rel.

**Wiring Diagram**

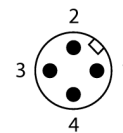
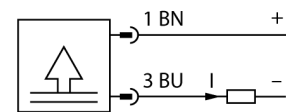

**Type designation** PT5000PSIG-13-LI3-H1131  
**Ident-No.** 6831467

**Pressure range**  
Relative pressure 0...344.74 bar rel.  
0...5000 psi  
0...34.47 MPa  
Admissible overpressure ≤ 861.8 bar  
Burst pressure ≥ 861.8 bar  
Response time < 2 ms, typ. 1 ms

**Power supply**  
Operating voltage 8...33 VDC  
Current consumption ≤ 20 mA  
Protective measure SELV according to EN 50178  
Short-circuit/reverse polarity protection yes / yes  
Protection type and class IP67 / III

**Outputs**  
Output 1 Analog output

**Analog output**  
Current output 4...20 mA  
Operating range 4...20 mA (2-wire)  
Load ≤ 1 kΩ  
Accuracy LHR analog output ± 0.3 % FS BSL  
Calibration accuracy 0-point 0.3 % FS  
Calibration accuracy full scale 0.3 % FS

**Temperature behaviour**  
Medium temperature -40...+125 °C  
Temperature coefficient zero point Tk0 ± 0.15 % of full scale/10 K  
Temperature coefficient span T<sub>is</sub> ± 0.15 % of full scale/10 K

**Ambient conditions**  
Ambient temperature -40...+85 °C  
Storage temperature -40...+85 °C  
Vibration resistance 20 x g (9...2000 Hz, 2...9 Hz with an amplitude +/-15 mm), acc. to IEC 68-2-6  
Shock resistance 100 g (11 ms), according to IEC 61508

**Housing**  
Housing material Stainless-steel/Plastic, V2A (1.4305)  
Pressure connection material Stainless steel A2 1.4305 (AISI 303)  
Pressure transducer material Ceramics Al<sub>2</sub>O<sub>3</sub>  
Sealing material FPM  
Process connection NPT 1/4"-18 male thread  
Wrench size pressure connection / coupling nut SW 21  
Electrical connection Connectors, M12 x 1  
Max. tightening torque housing nut 20 Nm

**Functional principle**

The pressure transmitters of the PT...-1 series operate with piezo-resistive ceramic measuring cells. The ceramic diaphragm is unbalanced in proportion to the pressure applied. Depending on the sensor type used, the processed signal is provided as an analog output signal 4...20mA (2-wire) or 0...10V (3-wire).

**Pressure Transmitter  
with current output (2-wire)  
PT5000PSIG-13-LI3-H1131**



---

**Reference conditions acc. to IEC 61298-1**

Temperature	15...+25 °C
Atmospheric pressure	860...1060 hPa abs.
Humidity	45...75 % rel.
Auxiliary power	24 VDC

---

**MTTF** 760 years acc. to SN 29500 (Ed. 99) 40 °C