

S-LINK V

Flexible Wire-saving System

New

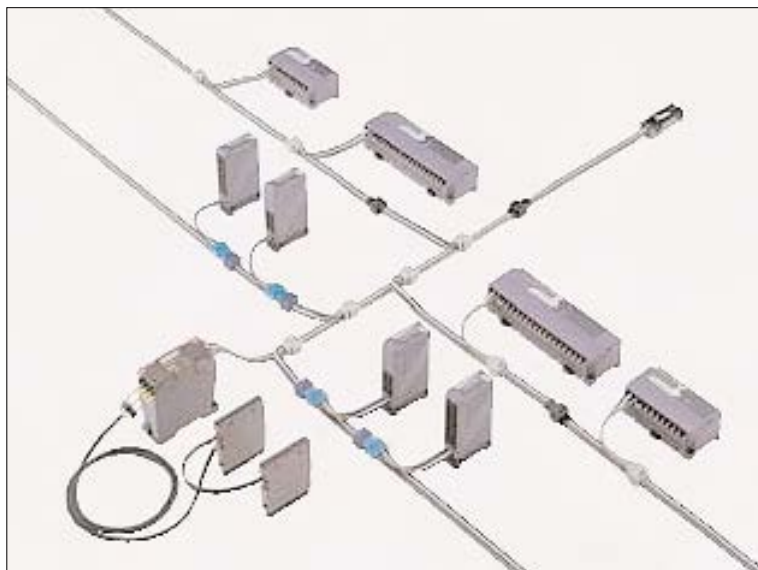

Connecting to the future...
our next generation wire-saving system

This product is introduced to only limited countries. Please contact our office for details.



Conforming to EMC Directive

Ideal wire-saving system that meets the strict demands of the FA worksite

Because of the high degree of evolution of recent automation-unmanned technology, the number of sensors and actuators at work in the FA worksite is increasing evermore. ON / OFF switching devices such as photoelectric sensors, inductive proximity sensors, electromagnetic valves, and the like, though simplistic in character, represent a huge burden on the workplace in the form of electricity layout design and wiring when used in large quantities.

Can ever increasing quantities of ON / OFF switching devices be wired in a fast, easy and compact way?

SUNX, as the leading FA sensor maker, has the answer the **S-LINK V**.

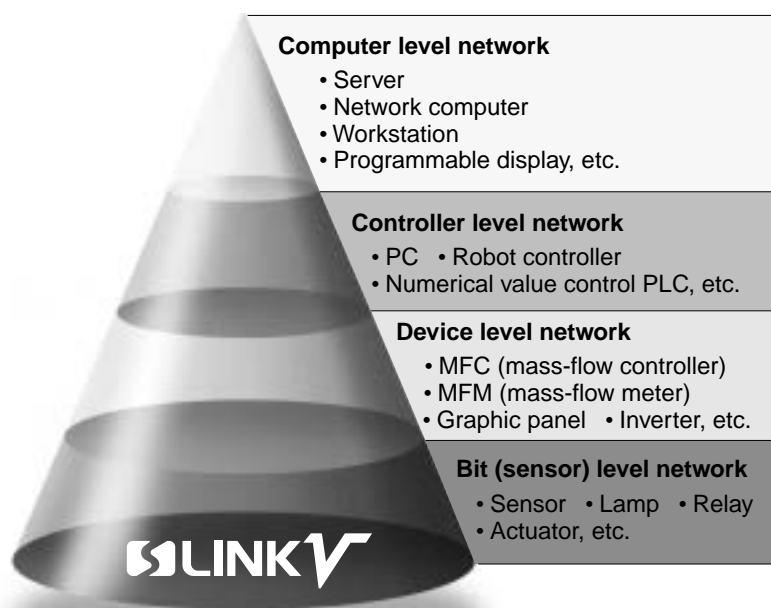

Design a layout with complete control and freedom

With no limit to the number of branches, layout design can be done simply without any wiring constraints thanks to the multiplication of control points (maximum of 512 points and 256 nodes, the largest in its class).

Truly dependable features

Simple and dependable communication protocols enable fast communication speed. We've also realized an extended communication range of 800 m 2624.672 ft maximum (when in C mode).

Super adaptability to the worksite

Because there are 3 different communication modes to choose from, you never have to change models even if the worksite or the equipment changes.

Multiplication of control points now a reality (largest level in its class)

With the maximum I/O control point count is 512, it boasts the highest level of control points for a bit level network. In addition, there are 256 connection nodes and, because of a variegated 1, 2, 4, 8, 16, and 32 point I/O unit lineup, you can efficiently mount up to 512 control devices to correspond to the quantity of I/O devices desired.

Conventional wire-saving system (remote I/O etc.)

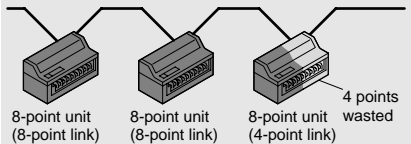

S-LINK V

Operates with superb cost, space, and I/O point count efficiency.

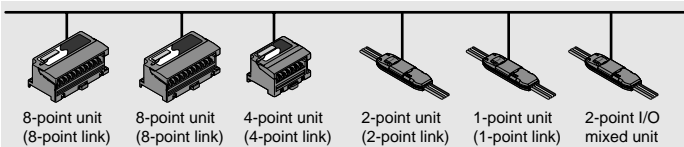

Alleviates the burden laid on engineer for designing and wiring

In order to enhance wiring layout freedom and control, labor-saving hook-up connectors are used enabling multiple 'T'-branch hookups wherever desired. Because there are no branch-count restrictions or main cable / branch cable differentiations, a genuine free-layout has been realized. It goes without saying that cascade wiring (bus wiring) as well as multiple branch wiring (star wiring) is also possible.

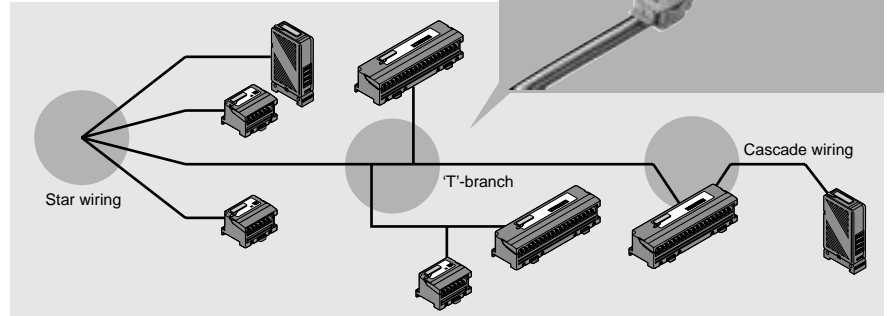

We've realized a bit level network without the need to specifying upper-level networks

Thanks to a PLC I/O connector, they can be connected to almost any PLC unit foreign or domestic. Also available is a computer control board that is PCI bus, ISA bus, even VME bus compatible. Any upper-level bus connection will do without the need to specify. They can also be linked to open networks (CC-Link, DeviceNet), which are becoming more and more popular throughout the world.

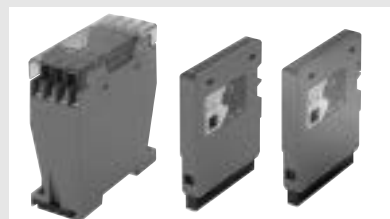

S-LINK V controller SL-VCU1
PLC I/O connectors SL-VS□, SL-VP□

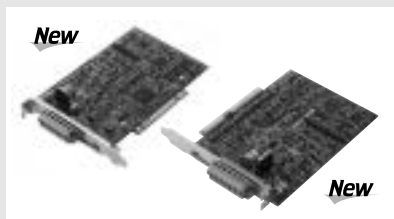

PC bus
S-LINK V control board SL-VPCI, SL-VISA



Mitsubishi Electric Corp. MELSEC-Q series
PLC bus direct connection controller SL-VMEL-Q

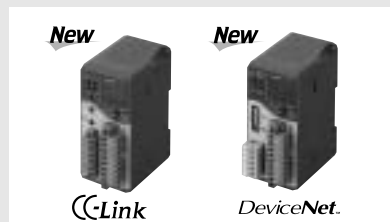

S-LINK V gateway controller for open network
SL-VGU1-C for CC-Link SL-VGU1-D for DeviceNet



VME bus
S-LINK V control board SL-VVMES2

Commercially available cables and connectors can also be used

Available for the S-LINK V is an exclusive 4-core flat cable and exclusive hook-up connectors for your labor-saving needs. On the other hand, they are also compatible with commercially available 4-core VCTF cables (without shield) and connectors enabling hookup with the cables you have already in stock. For worksites already wired-up, new wiring work does not have to be performed making these highly efficient devices help greatly reduce material and labor costs.

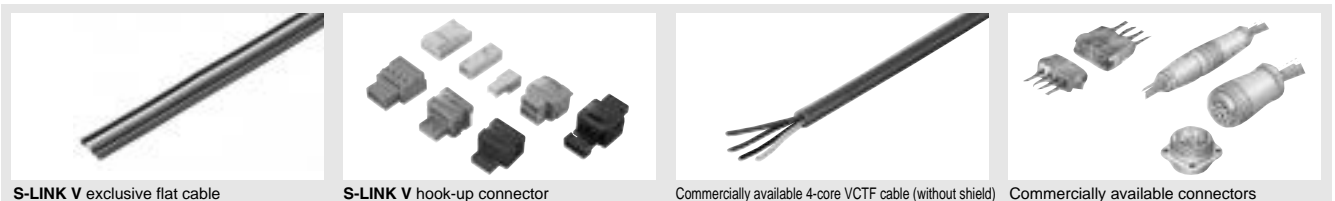

S-LINK V exclusive flat cable

S-LINK V hook-up connector

Commercially available 4-core VCTF cable (without shield)

Commercially available connectors

S-LINK V

All models conform to CE marking (EMC Directive)

EMI standard EN 50081-2

EMS standard EN 50082-2 and EN 61000-6-2

In noisy FA worksites, conforming to CE marking (EMC Directive) is the very least of its operating conditions. All **S-LINK V** units have withstood testing criteria that went above and beyond those reserved for field devices (sensors) that have passed the strictest of CE marking.

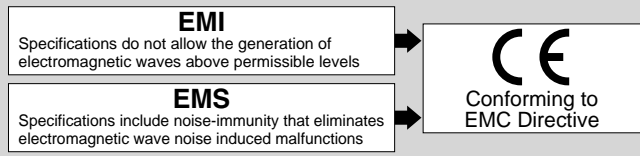

Superior noise-immunity performance

We've strengthened the conventional simple waveform noise resistance and enhanced reliability by eliminating the lost flexibility when setting up and the lost freedom and control when designing a layout.

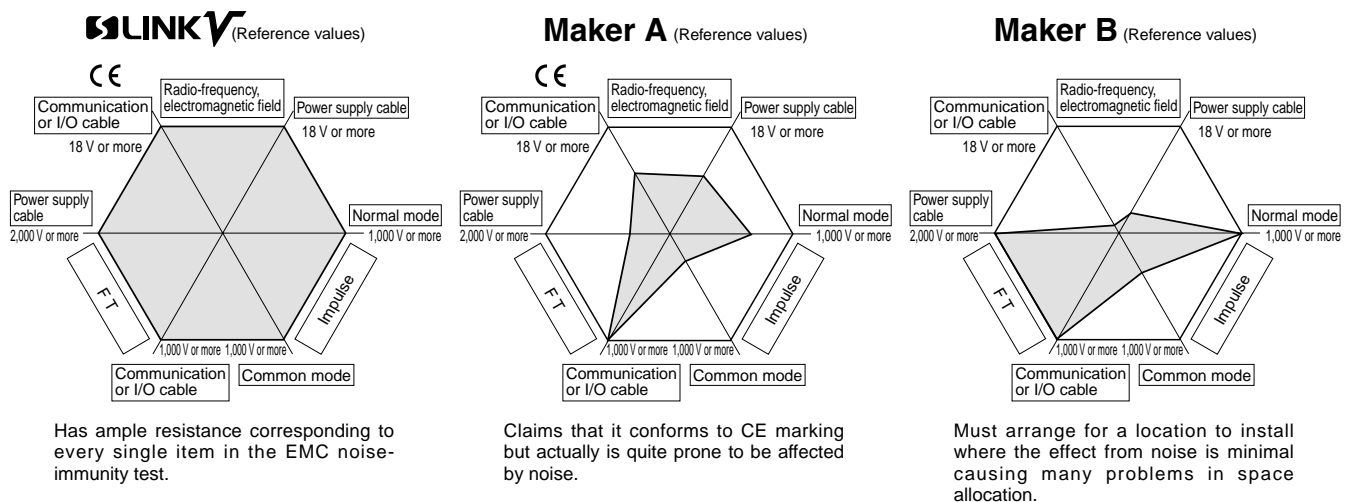

Notes: 1) This data is the result of in-house measurements and not based on authorized data issued by each respective maker.
2) FT represents first transient burst noise.

Enhanced maintainability

The system is consistently monitoring communications. In the unlikely event that a problem should arise, it lets the operators know immediately so that appropriate measures can be performed without delay. This feature enables quick and accurate troubleshooting.

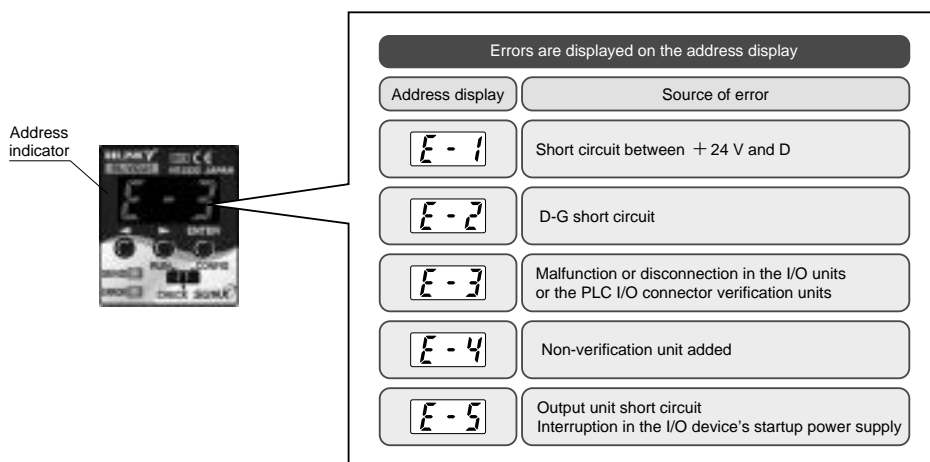

3 different selectable communication modes

Operating only the controller, communication modes can be selected for the entire system. Thanks to the three A, B, or C selectable modes, you don't need to reconfigure or modify the controller or the I/O units depending on the communication speed or the size of your system. By selecting a communication mode corresponding to the speed and communication range, the desired communication speed / range environment can also be realized.

Main items	Comm. Mode	A-mode	B-mode	C-mode
Refresh time (Note 1)		1.5 ms or less (for 32 points) 3.3 ms or less (for 128 points) 10.3 ms or less (for 512 points)	6.0 ms or less (for 32 points) 13.1 ms or less (for 128 points) 41.3 ms or less (for 512 points)	24.0 ms or less (for 32 points) 52.3 ms or less (for 128 points) 165.2 ms or less (for 512 points)
Max. communication range (Note 2)		50 m 164.042 ft	200 m 656.168 ft	800 m 2624.672 ft
Total cable length		100 m 328.084 ft	400 m 1312.336 ft	1600 m 5249.344 ft
I/O control points		32 to 512 points (set in 32 point step)(Note 3)		
Number of connected nodes		Maximum 256 nodes		

Notes: 1) This value represents the maximum refresh time.
2) The maximum communication range varies depending on the cables' conductor cross-section area as well as the node count.
3) 16 units of measure settable by software in the control board (SL-VISA, SL-VPCI, SL-VVMES2).
4) Communication modes cannot be changed while a communication is in progress.

Easy and flawless connections

Every type of hook-up connector is made available enabling a one-touch connection between the S-LINK V I/O units and the main cable or I/O devices such as sensors.

Branch cable to main cable connection and S-LINK V I/O unit to main cable connection

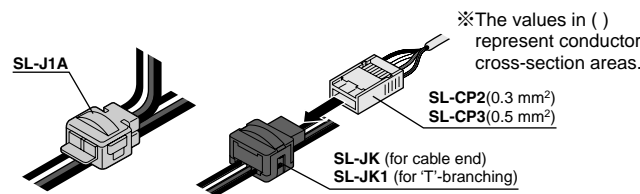

Using the 4-core flat cable, one-touch branching and extensions with hook-up connectors make overwhelming labor-saving possible. Also, in order to enhance the reliability of the connection, exclusive pliers are made available so that anyone can do it with ease.



Link from connection device to S-LINK V I/O unit

Using snap connectors renders wiring even for sensors and all types of I/O devices simple and easy.

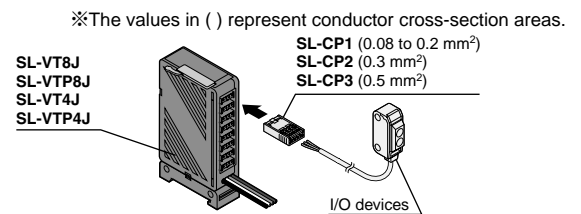

Connection device extensions

※The values in () represent conductor cross-section areas.

4 and 3-wire devices

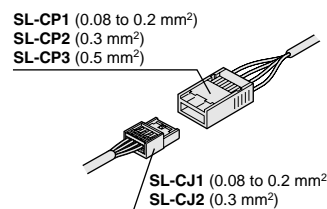

2-wire device and thru-beam type photoelectric sensor emitter

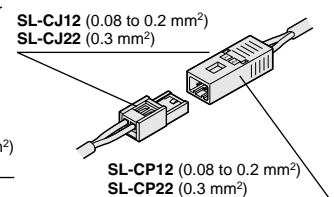

Merit of the 4-core flat cable

• Easy wiring thanks to a flexible cable

The ribbon-shaped 4-core flat cables are light, flexible, don't take too much space and can be used for easy wiring in the narrow spaces inside machines, along extended production lines, etc. They can be manipulated easily for branching, extensions, and even additional wiring.

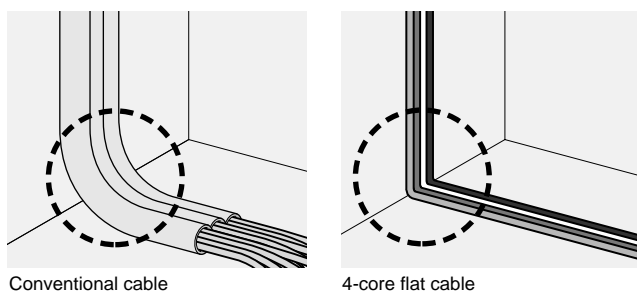

• Wire-saving can be achieved simultaneously

Its exclusive 4-core flat cable makeup consists of 2 signal wires (white / black) and 2 power supply wires (brown / blue). Now, only by wiring with these exclusive 4-core flat cables, power can be supplied to all I/O units scattered throughout the system as well as to every connected device.

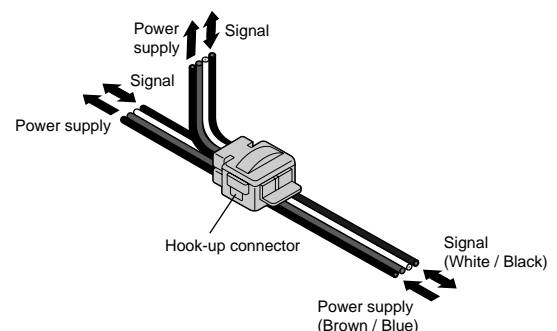

S-LINK V

Greatly enhanced system design efficiency

Because any wiring method, cascade, star, 'T'-branching, etc., can be chosen freely, there are no set restrictions for the layout. This renders your I/O device layout design incredibly efficient when compared to other wire-saving systems that only allow cascade wiring.

In addition, the **S-LINK V** model lineup includes a wide variation of units featuring 1, 2, 4, 8, 16, or 32 channels. Therefore, units can be connected as per the number of I/O device points enabling also the scattered installation of a small quantity of points. Surplus unit channels or excessive I/O device (sensors, actuators, etc.) interconnected installations are unnecessary.

Method of supplying power selectable

With the I/O arrayed terminal units (**SL-VTB□**, **SL-VTBP□**), the mounting or removal of short brackets enables the collective or separate supply of power from the system (**S-LINK V**) power supply and the load (I/O devices) source to be selected at will.

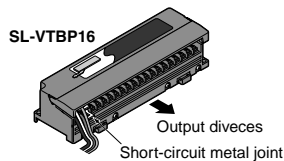

The system (**S-LINK V**) power supply and load (I/O devices) power supply can be made to supply power collectively. Therefore, electrical wiring used for the load (I/O devices) can be greatly reduced.

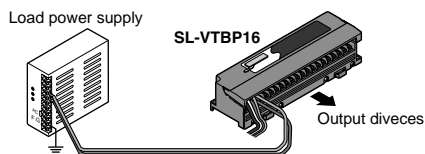

The system (**S-LINK V**) and load (I/O devices) power supplies can be made to supply power separately. This is not a wire-saving of power supply line method, however, the I/O devices only can be stopped without having to halt communications.

Specialized knowledge not required

Because communication occurs via hardware, program communication controls are absolutely unnecessary. Even worksites that are first-time users can put this system to work immediately after introduction.

Reduce the wiring of your existing system

The **S-LINK V** system can be connected to any maker's PLC. It can even be connected to PC expansion slots (ISA bus, PCI bus), VME bus, open networks (CC-Link, DeviceNet), etc. Because it is compatible to any controller and network, the **S-LINK V** can be introduced to variegated systems as they are already setup. Also, even when the control configuration has been changed (PLC to PC, etc.), conformance can be achieved only by changing the controllers.

In this way, the **S-LINK V** is a system that allows you to utilize to the fullest your worksite's layout investment accumulated until now.

Even if changing your present system for the **S-LINK V**, its features, including a reduced amount of cables, compact units, and 'T'-branching, make the addition of I/O devices as well as layout modifications simple and easy.

Only by switching the controller's communication mode, you can change the entire system. Purchasing each unit that conforms to specifications or changing the layout itself is absolutely unnecessary.

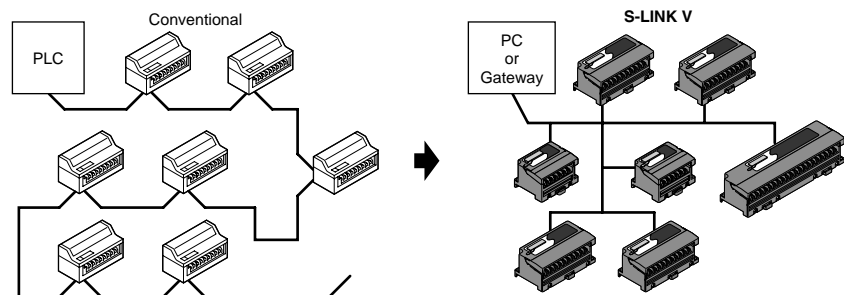

Highly reliable

Because 4-core flat cables and hook-up connectors enable the reduction of wires, the occurrence of faulty wiring or disconnections also goes down.

In addition, all **S-LINK V** units conform to CE marking (EMC Directive). This certification ensures high reliability against adverse effects from noise meaning that you can use them with reassurance in the most demanding of worksites.



Installation and removal of mid-system communication cables possible

In case of large-scale equipment, many times we construct each unit right on site in manufacturing facilities or in subcontract factories. Because the **S-LINK V** enables the easy removal of main or branch cables even in mid-system with commercially available connectors and intermediate terminal blocks, when constructing new units, if the electric wiring is already setup, assembly can be done just by installing those units at the time of delivery and connecting the **S-LINK V** wiring.

Also, the electrical wiring can be checked for each separate unit enabling the responsibility shared with subcontractors to be clearly defined.

Incredible space-saving now a reality

Each unit is compact making for great space savings along with minimizing control and intermediate boxes. This will contribute to the overall downsizing of the entire facility.

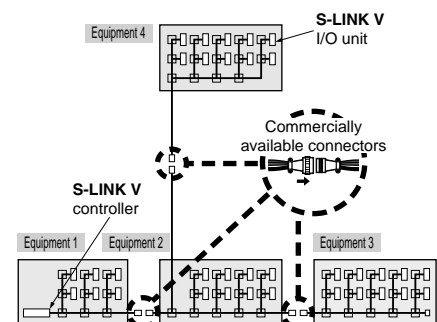

Greatly reducing labor when installing

Labor saving is realized thanks to the 4-core flat cable and hook-up connectors. Because the work of peeling cable coverings, mounting crimp terminals, tightening screws, wiring cable ducts, etc. is rendered unnecessary, installation time is minimized. This enables the lead-time to be shortened resulting in more equipment completed in less time. In addition, the overall stress level of onsite personnel is relieved and morale goes up. Surplus auxiliary materials (cables, intermediate terminal blocks, etc.) are unnecessary making for reduced total cost. Also, using connectors to add on or change sensors and units is made easy. No wastes from peeled off cable ends meaning you are left with a wire-saving, environmentally friendly system.



Noise-immunity performance at par with world standards

S-LINK V units conform to CE marking. The CE marking is a certification that guarantees reliable noise resistance. We provide this world standard noise-resistance performance to you, our valued customers.

We've realized low required maintenance

Because operators can receive error outputs for each malfunction cause, they can look into the trouble at hand immediately. Also, damaged I/O devices can be replaced easily with the help of connectors.

Variegated I/O units available

Made available are 1 and 2 channel I/O units (**SL-VCH**) that can be connected without wasting mid-system scattered I/O units, relay output terminal units (**SL-VTPR**) that can be connected to high capacity output devices up to 3 A, connector I/O units (**SL-VT**, **SL-VTP**, **SL-VT16C1**, **SL-VTP16C1**) that come in installation-friendly 4, 8, and 16 channel types, and 4, 8, 16, and 32 channel type I/O arrayed terminal units (**SL-VTB**, **SL-VTBP**). You can select any of these in accordance with your specific worksite environment.

Worksite installation friendly and easily connectable terminal blocks

Ample + COM and - COM terminals are imbedded in the I/O terminals rendering intermediate terminal blocks unnecessary.

Common remote I/O

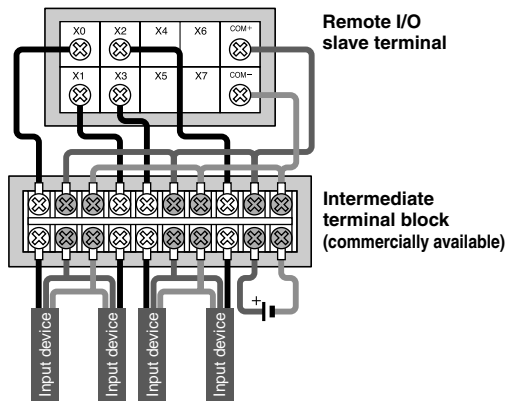

- The connection of 2 or 3-wire sensors was not envisioned with a low amount of COM terminals
(There are few makers that provide + COM terminals or make 3-wire sensor connections possible.)
- The present situation among current users is to prepare separate connecting terminal blocks and reconnect anew the remote I/O terminals.
- It is neither wire-saving nor labor-saving

Less time required means lower construction costs

In recent years, many production processes have been moved overseas and cases where equipment had to be set up in those new foreign worksites have increased dramatically.

It goes without saying that the period of time needed for setting up the worksite equals the period personnel must remain in those countries. A long installation period means an overextended stay bringing up overall costs.

The **S-LINK V** promises a short installation time period making for great reductions in labor costs for electricians.

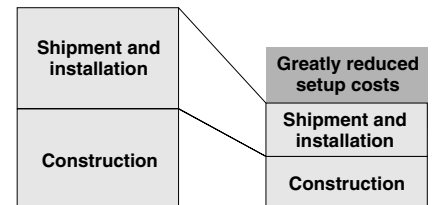

Conventional
(remote I/O, etc.)

S-LINK V

S-LINK V 4, 8, and 16 channel unit

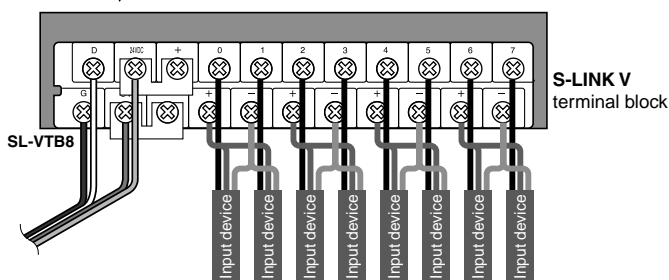

- The I/O units (**SL-VCH** and **SL-VT**/**VTP**) can be connected using hook-up connectors greatly reducing wiring work and the number of intermediate terminal blocks.

S-LINK V

Comparison with conventional wiring

Setting conditions

- Estimated workload for wiring a control box to 3 processing machines.
- The control box is 10 m 32.808 ft, 15 m 49.213 ft, and 20 m 65.617 ft away from the machines respectively.
- Each machine has 128 I/O points for a total of 384 points.

Estimate results

The S-LINK V system was completely setup in 161 hours and 18 minutes (about 20 days[※]). A super quick installation when compared to conventional wiring.

※ 8 hours/day

Time needed for wiring work

- If using S-LINK V: 23 hours 42 minutes
- If using conventional wiring: 185 hours

S-LINK V

Total time for wiring work

① + ② + ③ = 23 hours and 42 minutes

① Time for wiring work = 1 hour and 37 minutes

② Time for wiring work = 26 minutes

③ Time for wiring work = 21 hours and 39 minutes

① Connecting the PLC to the control box's inner terminal blocks

Time for wiring work = 1 hour and 37 minutes

I/O connector attached cable × 12

- PLC module side: Connector connection
- Terminal block side: Multi-core cable

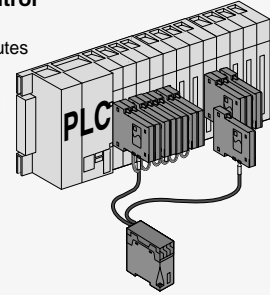

Control board

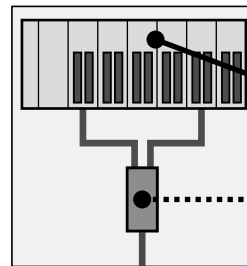

PLC

Input module (64 points) × 6 units
Output module (64 points) × 6 units

4-core flat cable × 1

Conventional wiring

Total time for wiring work

① + ② + ③ = 185 hours

① Time for wiring work = 35 hours

② Time for wiring work = 70 hours

③ Time for wiring work = 80 hours

① Connecting the PLC to the control box's inner terminal blocks

Time for wiring work = 35 hours

I/O connector attached cable × 12

- PLC module side: Connector connection
- Terminal block side: 420 multi-core cable ends must be peeled off, crimp terminals must be installed, and screws must be tightened.

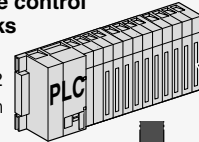

Control board

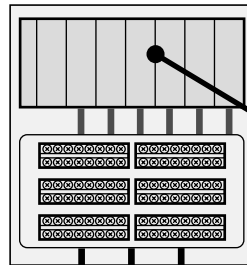

PLC

Input module (64 points) × 6 units
Output module (64 points) × 6 units

30-core flat cable × 5 per machine

③ Inside machine (S-LINK V I/O units to I/O)
 Time for wiring work = 21 hours and 39 minutes
 Use **S-LINK V** 8 channel I/O units

- S-LINK V units connected to 4-core flat cable with hook-up connectors.
- Each I/O device connected to S-LINK V units with snap male connectors.

② Control box (S-LINK V controller) to machine
 Time for wiring work = 26 minutes
S-LINK V exclusive 4-core flat cable

- Use hook-up connectors to each machine and branch them.

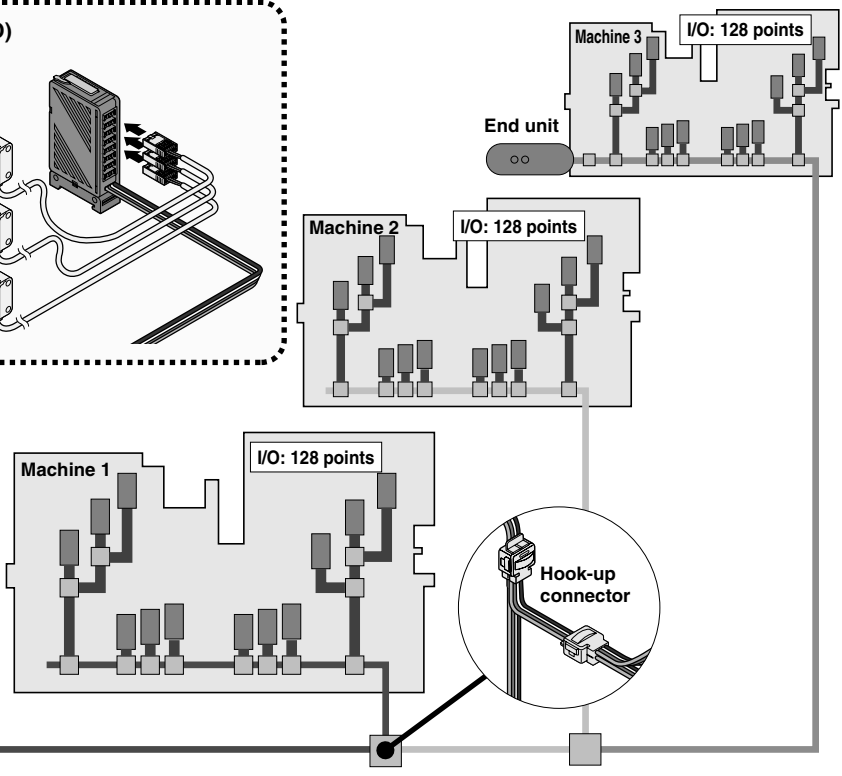

③ Inside machine (Control box terminal blocks to I/O)
 Time for wiring work = 80 hours

Connect the 128-point I/O device cables in one machine to the terminal blocks

- For each output device cable the ends must be peeled off, the lead wire end must be arranged, crimp terminals must be installed, and screws on the terminal block must be tightened.

② Terminal connections between inside the control box and inside machines
 Time for wiring work = 70 hours

In order to arrange either ends of 140 lead wires for each machine, 280 wires are required.
 For 3 machines, 840 wires.

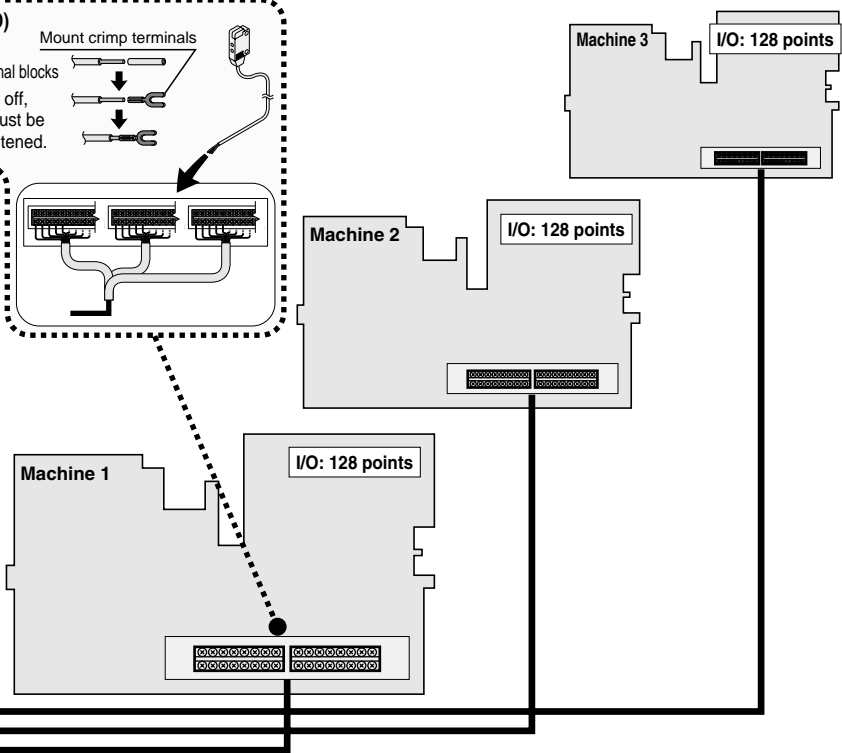

S-LINK V

Compatible with global open networks

In the event of exporting equipment constructed using any open network or should there be some unique user specifications, the **S-LINK V** I/O units can be left as they are in the system and, just by changing the **S-LINK V** controller to a gateway controller, you can connect our system to different networks such as CC-Link or DeviceNet quickly and easily.



Enhances open network functions

You can greatly increase the device connection points and total wiring length of your open network and construct a long-distance, multi-point transfer network.

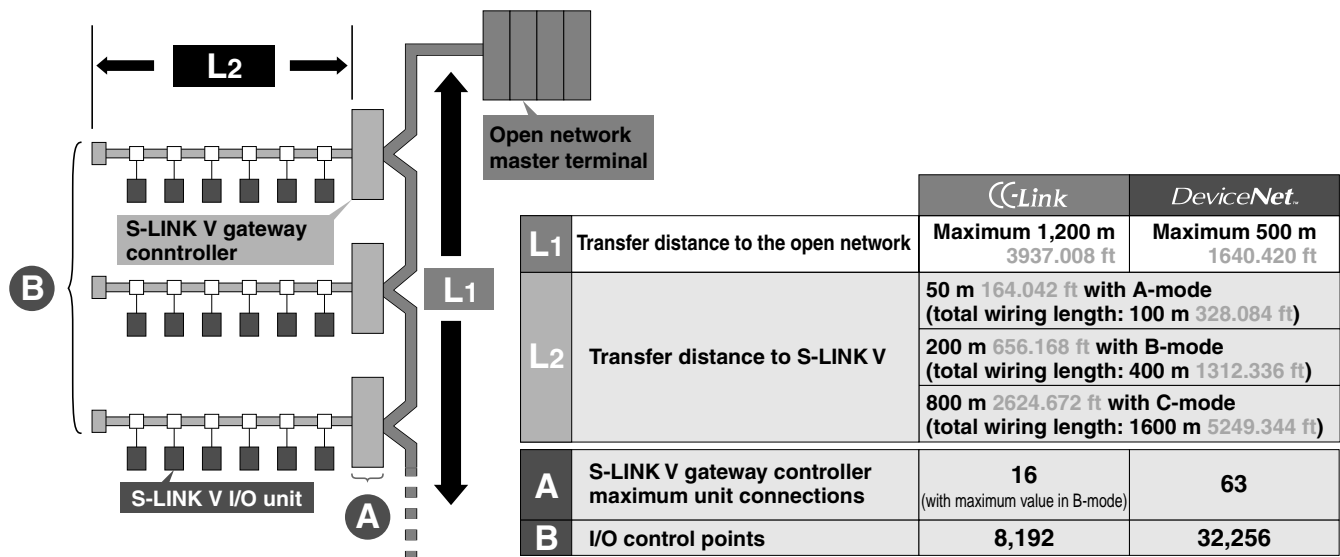

Put your open network's capabilities to work for you

Example when using CC-Link:

The conventional model, forerunner to this new system, could only handle up to a 128-point I/O device control. The new **S-LINK V** can control 4 times that amount for a fabulous 512 point maximum. However, the CC-Link has the same amount of 4 stations. Because of this, it is possible for the **S-LINK V** to economize stations, which can then be utilized by intelligent devices such as robot controllers, etc.

APPLICATIONS

Semiconductor manufacturing equipment

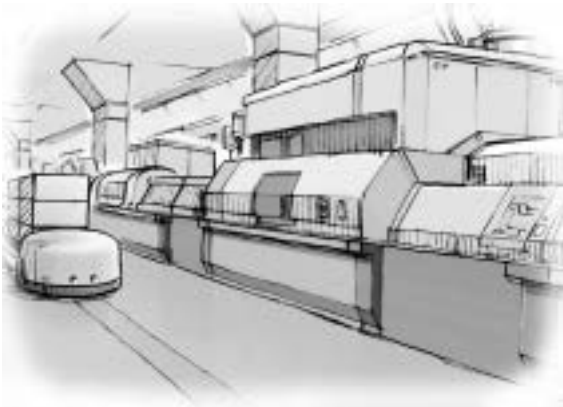

The era of the 300 mm 12 in wafer has arrived and manufacturers demand ways to save space in their clean rooms. Both of the **S-LINK V**'s I/O units are space-saving types greatly contributing to the reduction of square-footage needed by equipment by significantly decreasing the amount of total wiring including power supply cables.

Automated assembly equipment



It is of great necessity for industry to meet the fast introduction of new generations of, as well as the growing demand for, HDD, DVD, cellular phone and other high-tech device manufacturing equipment. The **S-LINK V** is a wire-saving system that offers a high level of control and freedom in any and all situations. Because of this, it not only reduces the overall manpower in the manufacturing sector but also does the same for development and design sectors as well.

Distribution and conveyance equipment



This system is perfect for efficient wire saving for I/O devices scattered all over a wide area. If by any chance there were a disconnection of wires, the problem area can be located immediately making this system easily maintainable.

S-LINK V

SYSTEM LAYOUT

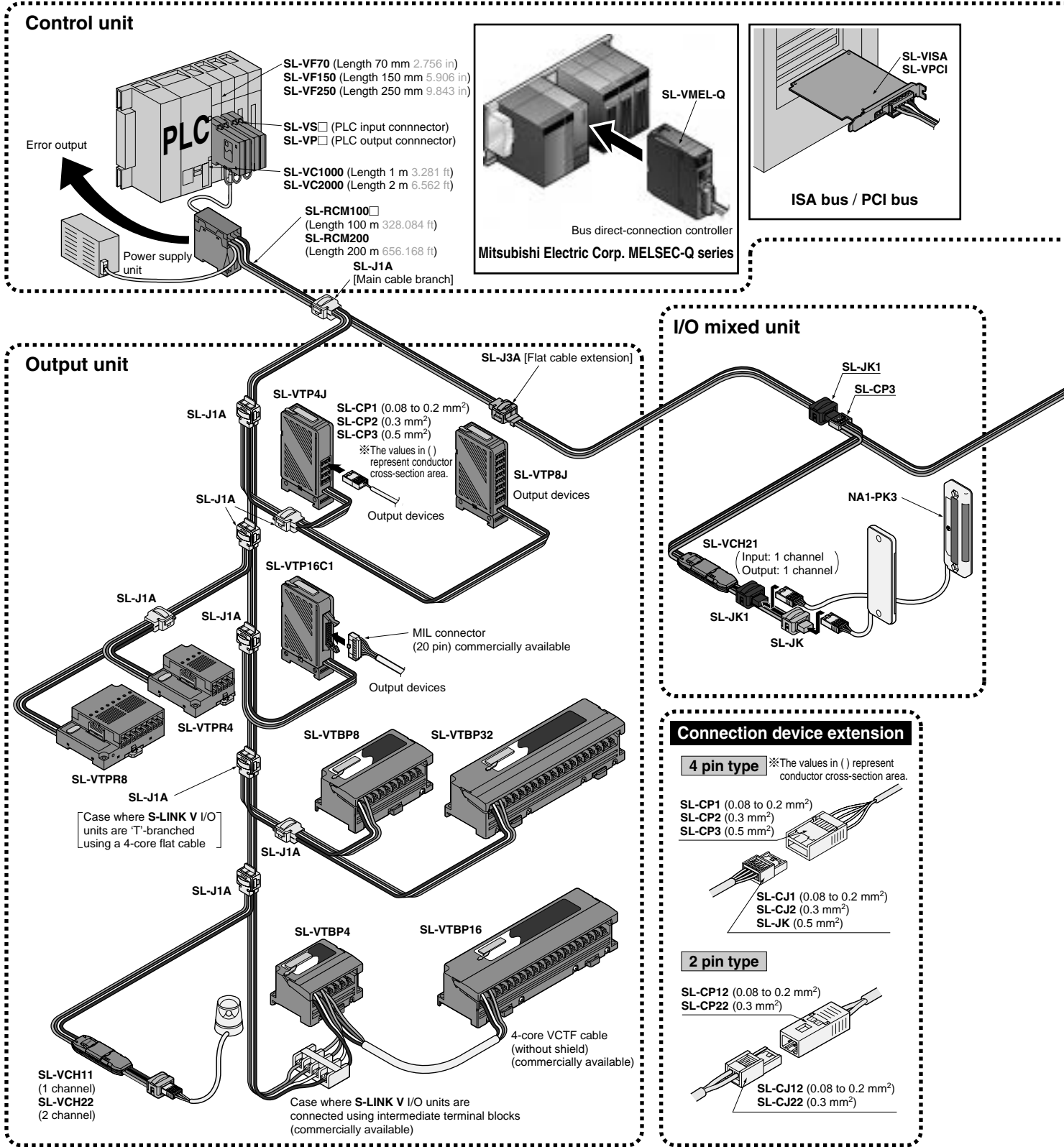

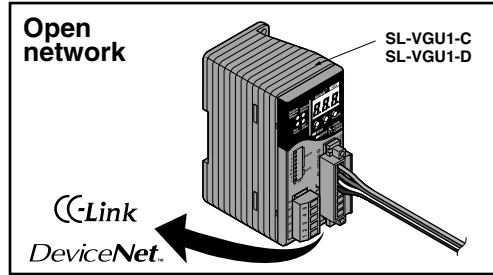
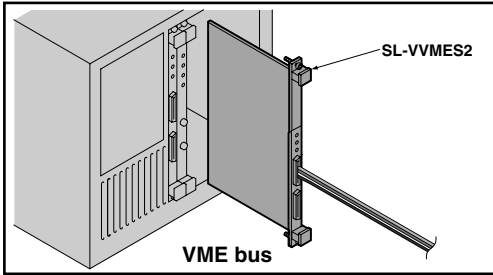

Input unit

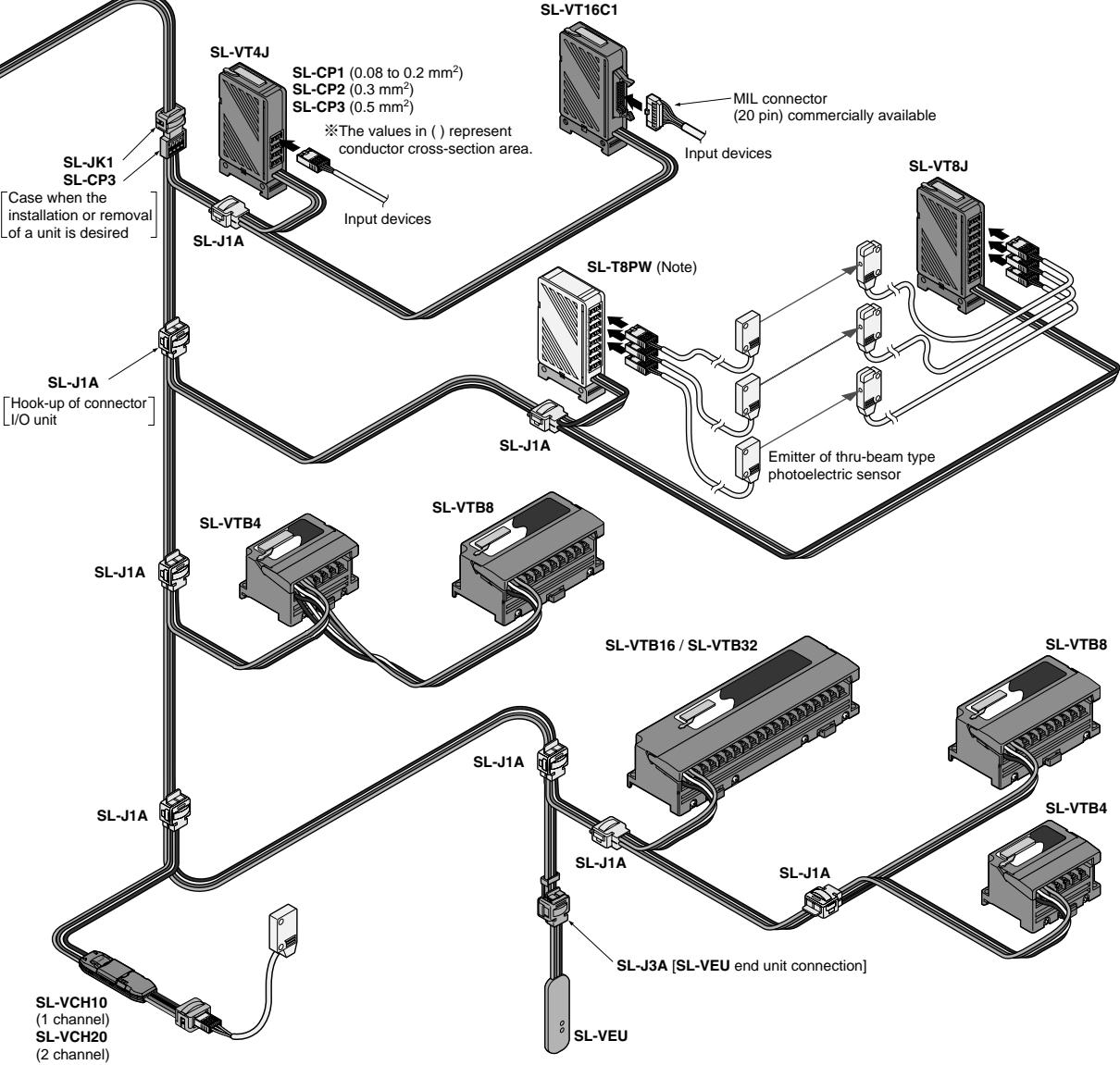

Note: Because the exclusive 4-core flat cable allows a +24 V-0 V DC power supply, thru-beam type sensor emitters can be connected easily with low installation work.



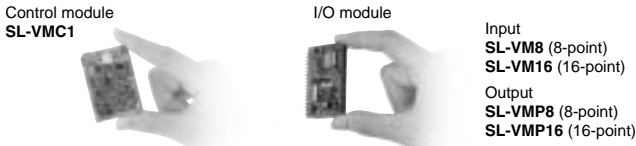



PCB mounting

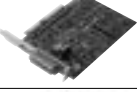

S-LINK V

ORDER GUIDE

Control units

Designation	Appearance (Note)	Model No.	Description
S-LINK V controller	 CE	SL-VCU1	It can control the signal transmission of the complete system. It also monitors the signal transmission line and specifies the addresses of the disconnected devices if the breaks, etc.
S-LINK V control board for ISA bus	 CE	SL-VISA	It can be fitted into the expansion slot (ISA bus) of a personal computer to control the S-LINK V system.
S-LINK V control board for PCI bus	 CE	SL-VPCI	It can be fitted into the expansion slot (PCI bus) of a personal computer to control the S-LINK V system.
S-LINK V control board for VME bus	 CE	SL-VVMES2	It can be directly connected to the VME bus line to control the S-LINK V system. It provides two S-LINK V ports, each allowing 512 I/O points maximum, so that a total of 1,024 I/O points can be controlled.
S-LINK V gateway controller for open network	 CE	SL-VGU1-C	S-LINK V gateway controller for connection open network CC-Link, promoted by CC-Link Association.
	 CE	SL-VGU1-D	S-LINK V gateway controller for connection open network DeviceNet, promoted by ODVA.
Mitsubishi Electric Corp. MELSEC-Q series bus direct hook-up controller	 CE	SL-VMEL-Q	Directly connects with Mitsubishi Electric Corp.'s MELSEC-Q series base unit to control the S-LINK V system.

Note: Components with 'CE' mark conform to the CE marking EMC Directive.

End unit

Designation	Appearance (Note)	Model No.	Description
End unit	 CE	SL-VEU	Connect to the end of the main cable. At least one unit is required for each system. (Refer to the user's manual for details.) Use the included MS-CH DIN rail mounting bracket for DIN rail installation. The DIN rail mounting bracket can be affixed with screws.

Note: Components with 'CE' mark conform to the CE marking EMC Directive.

ORDER GUIDE

PLC related units











Designation	Appearance (Note1)	Model No.		Description			
		For input	For output	Manufacturer	PLC	PLC input module (Note 4)	PLC output module (Note 4)
PLC input connector PLC output connector (Note 2, 3)	<p>Fujitsu connector specs. MIL connector specs. </p> <p>PLC input connectors PLC output connectors (same shape) </p> <p>The listed PLC I/O modules (NPN only) allow the mating PLC I/O connector to be plugged on them for signal transmission between the PLC and the S-LINK V controller.</p> <p>The PLC I/O connector converts I/O data from serial to parallel, and vice versa. I/O points: 32 points per connector</p> <p>If connecting 9 PLC connectors or more to the S-LINK V controller, use 2 control cables and separate them into 2 stems for a parallel connection.</p>	SL-VS1	SL-VP1	Matsushita Electric Works, Ltd.	FPΣ (Excluding the FPG-C32T) FP2 FP3, FP10S FP10SH	FPG-XY64D2T (X side) FP2-X32D2 AFP33027-F	FPG-XY64D2T (Y side) FP2-Y32T AFP33487-F
				Toshiba Machine Co., Ltd.	TC200	TC64DI	TC64DON
		SL-VS2	SL-VP2	Fuji Electric Co., Ltd.	NS series	NS-X64-1 NS-XY64-1 (X side)	NS-Y64-T1 NS-XY64-1 (Y side)
					F55	NV1X3204 NV1X3204-W NV1X3206	NV1Y32T05P1
					F70	NC1X3204 NC1X3204-3 NC1X3206 NC1X6404 NC1X6406 NC1W6406T (X side)	NC1Y32T05P1 NC1Y64T05P1-1 NC1W6406T (Y side)
					F80H, F120H F120S F140S F15XS	FTU125A FTU126A FTU127C FTU612A (X side)	FTU222A FTU227C FTU612A (Y side)
		SL-VS3	SL-VP3	Mitsubishi Electric Corp.	AnS	A1SX41 A1SX41-S1 A1SX42 A1SX42-S1 A1SH42 (X side) A1SH42-S1 (X side)	A1SY41 A1SY42 A1SH42 (Y side) A1SH42-S1 (Y side)
					AnN, AnA, AnU QnA, QnAs	AX42 AH42 (X side) QX41 QX42 QH42P (X side)	AY42 AH42 (Y side) QY41P, QY42P QH42P (Y side)
					Q	AJ35TC1-32D	AJ35TC1-32T
					A2CJ	AJ35TC1-32D	AJ35TC1-32T
SL-VS4	SL-VP4	Fuji Electric Co., Ltd.	SX series	NP1X3206-W NP1X6406-W	NP1Y32T09P1 NP1Y64T09P1		
			Sharp Manufacturing Systems Corp.	JW20, JW20H JW30H JW50H	JW-234N JW-264N JW-34NC JW-64NC	JW-232S JW-262S JW-32SC JW-62SC	
SL-VS5	SL-VP5	Omron Corp.	CS1	CS1W-ID231 CS1W-ID261 CS1W-MD261 (X side)	CS1W-OD231 CS1W-OD261 CS1W-MD261 (Y side)		
			CVM1, CV C500, C1000H C2000H	C500-ID219	C500-OD213		
			C200H series	C200H-ID216 C200H-ID217	C200H-OD218 C200H-OD219		
			CQM1	CQM1-ID213	CQM1-OD213		
		Yokogawa Electric Corp.	FA500	XD64-6N (X side) WD64-6N (Y side)	YD64-1A WD64-6N (Y side)		
			FA-M3 FA-M3R	F3XD32-3N F3XD64-3N	F3YD32-1A F3YD64-1A		
		Hitachi Ltd.	EH-150 series	EH-XD32	EH-YT32		
		Toshiba Corp.	T3	DI-335, DI-335H	DO-335		
Yasukawa Electric Corp.	GL20, GL40S GL60S GL60H GL70H	—	B2604				
SL-VS6	SL-VP6	Hitachi Ltd.	H series	XDC24D3H XDC24D2H	YTR24D3H YTR24DH		
SL-VS7	—	Yasukawa Electric Corp.	GL20, GL40S GL60S GL60H GL70H	B2605	—		
SL-VS8	SL-VP8	Rockwell Automation (Allen-Bradley)	SLC500	1746-IV32	1746-OV32		
Cascade cable		SL-VF70		Length: 70 mm 2.756 in			
		SL-VF150		Length: 150 mm 5.906 in			
		SL-VF250		Length: 250 mm 9.843 in			
Control cable		SL-VC1000		Length: 1 m 3.281 ft			
		SL-VC2000		Length: 2 m 6.562 ft			

- Notes: 1) Components with 'CE' mark conform to the CE marking EMC Directive.
 2) The PLC I/O connectors use Fujitsu connectors. However, **SL-VS1**, **SL-VS6**, **SL-VS8**, **SL-VP1**, **SL-VP6** and **SL-VP8** connectors use MIL connectors.
 3) PLC I/O connectors are connectable to S-LINK V controller **SL-VCU1** only.
 4) X side and Y side indicate the input and the output connectors, respectively, of the compound input / output module.
 5) The connector cap is attached with the PLC I/O connector.
 6) The cascade cable and the control cable do not conform to CE marking.

S-LINK V

ORDER GUIDE

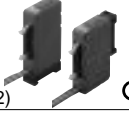
I/O units

Designation	Appearance (Note)	Model No.	Description		
1 channel input unit	 CE	SL-VCH10	1 NPN input	Scattered low count I/O units can be connected easily by 1 channel increments. The connection with the I/O units can be done using hook-up connectors greatly reducing wiring work.	
2 channel input unit	 CE	SL-VCH20	2 NPN inputs		
2 channel I/O mixed unit	 CE	SL-VCH21	1 NPN input and 1 NPN output		
1 channel output unit	 CE	SL-VCH11	1 NPN output		
2 channel output unit	 CE	SL-VCH22	2 NPN outputs		
Relay output terminal unit				A 3A maximum high capacity load can be connected. The relays can be replaced easily one channel at a time.	
4 relay output terminal	 CE	SL-VTPR4	4 relay outputs		
8 relay output terminal	 CE	SL-VTPR8	8 relay outputs		
Connector I/O unit	 CE	4 channel snap-connector input unit	SL-VT4J	4 NPN inputs	4, 8 input or 4, 8 output devices are connectable with snap male connectors. The output unit is incorporated with an output signal hold function, which retains the output state just prior to an error on the signal transmission line.
		8 channel snap-connector input unit	SL-VT8J	8 NPN inputs	
		4 channel snap-connector output unit	SL-VTP4J	4 NPN outputs	
		8 channel snap-connector output unit	SL-VTP8J	8 NPN outputs	
		16 channel MIL connector input unit	SL-VT16C1	16 NPN inputs	
16 channel MIL connector output unit	(Note 2)  CE	SL-VTP16C1	16 NPN outputs	Since connection can be made with an MIL connector, 16 input or 16 output devices can be connected to this slim I/O unit. The output unit is incorporated with an output signal hold function, which retains the output state just prior to an error on the signal transmission line.	
I/O arrayed terminal unit	 CE	Input terminal	SL-VTB4	4 NPN inputs	They are screw-on terminal units to which 4, 8, 16 or 32 input devices are connectable. Since power supply terminals have been provided for two input channel, neat wiring is possible.(Note 3)
			SL-VTB8	8 NPN inputs	
			SL-VTB16	16 NPN inputs	
		Output terminal	SL-VTBP4	4 NPN outputs	They are screw-on terminal units to which 4, 8, 16 or 32 output devices are connectable. The output unit is incorporated with an output signal hold function, which retains the output state just prior to an error on the signal transmission line.
			SL-VTBP8	8 NPN outputs	
			SL-VTBP16	16 NPN outputs	
			SL-VTBP32	32 NPN outputs	

Notes: 1) Components with 'CE' mark conform to the CE marking EMC Directive.

2) For device connections, using the Matsushita Electric Works, Ltd. MIL connector attached cable is most recommended. Connect in a way so that the 20-core connector links up with the 16-channel unit.

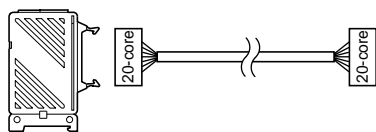

16 channel MIL connector attached cable (20-core)
Matsushita Electric Works, Ltd. AY15840, etc.
I/O unit PC relay terminal / PC terminal additional mounting cable

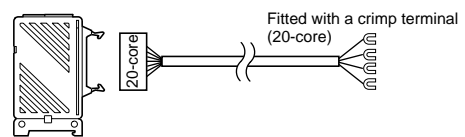



16 channel MIL connector attached cable (20-core)
Matsushita Electric Works, Ltd. AY15853, etc.
I/O unit Multi-core crimp terminal cable for relay terminal

Compatible with Matsushita Electric Works, Ltd. MIL connector relay terminal pin arrangement.

3) 4, 8, and 16-point unit



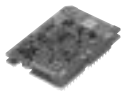





ORDER GUIDE

PCB mounting module

Designation	Appearance (Note)	Model No.	Description	
Control module	 CE	SL-VMC1	Your in-stock original board can be used as a substitute for the S-LINK V controller.	
I/O module	 CE	SL-VM8	8 NPN inputs	Your in-stock original board can be used as a substitute for the S-LINK V I/O unit. Select the most suitable board corresponding with the quantity of I/O devices to be connected.
		SL-VM16	16 NPN inputs	
		SL-VMP8	8 NPN outputs	
		SL-VMP16	16 NPN outputs	

Notes: Components with 'CE' mark conform to the CE marking EMC Directive.

Connectors

Designation	Appearance	Model No.	Description	
Hook-up connector	 (Note)	SL-J1A 10 pcs. per set	It creates a 'T'-branch connection between two S-LINK V exclusive flat cables. For 0.5 mm ² flat cable to 0.5 mm ² flat cable connection (Gray)	
Cable extension hook-up connector		SL-J3A 10 pcs. per set	It can extend the S-LINK V exclusive flat cable. For 0.5 mm ² flat cable to 0.5 mm ² flat cable connection (Black)	
Cable end socket-branch hook-up connector		SL-JK 10 pcs. per set	Hook-up connector (SL-CP) for linking the ends of exclusive flat cables (0.5 mm ² , 4-core) to I/O devices using snap male connectors (light blue)	
'T'-branch hook-up connector		SL-JK1 10 pcs. per set	Hook-up connector (SL-CP) for linking mid-system exclusive flat cables (0.5 mm ² , 4-core) to I/O devices using snap male connectors (blue)	
4-pin type snap female connector	 (Note)	SL-CJ1(White) 10 pcs. per set	For 0.08 to 0.2 mm ² (Conductor cross-section area) Wire dia.: $\phi 0.7$ to $\phi 1.2$ mm $\phi 0.028$ to $\phi 0.047$ in	Snap female connector to connect with the snap male connector SL-CP1 and SL-CP2
	 (Note)	SL-CJ2(Black) 10 pcs. per set	For 0.3 mm ² (Conductor cross-section area) Wire dia.: $\phi 1.1$ to $\phi 1.6$ mm $\phi 0.043$ to $\phi 0.063$ in	
4-pin type snap male connector	 (Note)	SL-CP1(White) 10 pcs. per set	For 0.08 to 0.2 mm ² (Conductor cross-section area) Wire dia.: $\phi 0.7$ to $\phi 1.2$ mm $\phi 0.028$ to $\phi 0.047$ in	Snap male connector to link I/O devices with connector I/O units SL-VT4J / SL-VT8J and SL-VTP4J / SL-VTP8J and to link the S-LINK V I/O units to hook-up connectors SL-JK / SL-JK1 .
	 (Note)	SL-CP2(Black) 10 pcs. per set	For 0.3 mm ² (Conductor cross-section area) Wire dia.: $\phi 1.1$ to $\phi 1.6$ mm $\phi 0.043$ to $\phi 0.063$ in	
	 (Note)	SL-CP3(Greenish blue) 10 pcs. per set	For 0.5 mm ² (Conductor cross-section area) Wire dia.: $\phi 1.7$ to $\phi 2.5$ mm $\phi 0.067$ to $\phi 0.098$ in	

Note: For UL compatibility, please contact our office.

Accessories

• **NPS-CV**
(Protective cover for the **SL-VCU1**)

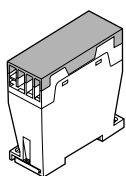

• **MS-SL-2**
(Mounting base for connector I/O units)

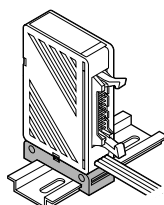

S-LINK V

ORDER GUIDE







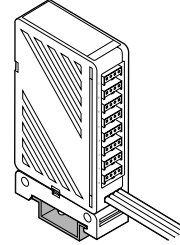





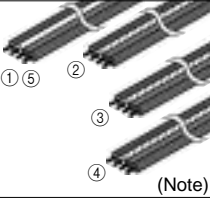

Option

Designation	Model No.	Description
Connector I/O unit mounting bracket 8-branch connector tap mounting bracket	MS-DIN-3	It is a DIN rail mounting bracket which can be fitted on the mounting base of SL-VT(P)4J , SL-VT(P)8J , SL-VT(P)16C1 and SL-T8PW

Connector I/O unit mounting bracket 8-branch connector tap mounting bracket • MS-DIN-3

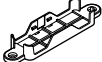

Others

Designation	Appearance (Note 1)	Model No.	Description	
Handy monitor	 CE	SL-VHM1	Can monitor and operate all units connected to the S-LINK V system. Highly efficient for debugging I/O units (I/O check)	
8-branch connector tap		SL-T8PW	Connects easily to up to 8 thru-beam type photoelectric sensor emitters or S-LINK V I/O devices with snap male connectors.	
2-pin type snap female connector	 (Note)	SL-CJ12 (White) 10 pcs. per set	2-wire type device optimal for cable relays to the thru-beam type beam sensor emitters	
	 (Note)	SL-CJ22 (Black) 10 pcs. per set		
2-pin type snap male connector	 (Note)	SL-CP12 (White) 10 pcs. per set		
	 (Note)	SL-CP22 (Black) 10 pcs. per set		
Exclusive flat cable	 (Note)	SL-RCM100	S-LINK / S-LINK V exclusive flat cable Conductor cross-section area: 0.5 mm ² (4-core) Outer diameter: $\phi 2.5 \text{ mm} \times 4$ $\phi 0.098 \text{ in} \times 4$	
		SL-RCM100-PK		Length: 100 m 328.084 ft
		SL-RCM100-GN		
		SL-RCM100-GY		
		SL-RCM200		
Exclusive cabtyre cable		SL-CBM100	Length: 100 m 328.084 ft	
		SL-CBM200	Length: 200 m 656.168 ft	
Exclusive pliers		SL-JPS	Hook-up connector (SL-J□) can be connected in one grip.	
Exclusive ratchet pliers		SL-JPD	Because of the ratchet mechanism, hook-up connector (SL-J□) can be simply connected in one grip.	
SL-CP3 exclusive pliers		SL-JPE	4-pin type snap male connector (SL-CP3) can be connected in one grip.	
Snap male / female connector exclusive pliers		SL-JPC	Snap female connector (SL-CJ□) and snap male connector (SL-CP1/CP2 and SL-CP11/CP12) can be connected in one grip.	
Address label		SL-VMA1	By sticking the labels on the respective S-LINK V devices, the set addresses can be confirmed at one glance. 2 labels (in sets of 2) × 2 sets: 4 labels	
DIN rail mounting bracket for the SL-VCH□		MS-CH × 10 10 pcs. per set	Mounting bracket enabling the SL-VCH series I/O units to be mounted onto a 35 mm 1.378 in width DIN rail. They can also be affixed with screws. (When affixing with screws, prepare two M4 pan head screws separately.)	
I/O unit holder for SL-VCH□		MS-SLH 5 pcs. per set	It is used to mount the SL-VCH series unit. (Please arrange two M4 pan head screws separately.)	

Notes: 1) Components with 'CE' mark conform to the CE marking EMC Directive.

2) For UL compatibility, please contact our office.

PRECAUTIONS FOR PROPER USE



- This product does not possess control functions needed for accident prevention or safety maintenance. Handle safety related or emergency stop signals without passing them through the **S-LINK V** system due to fail-safe considerations.
- Before touching this product, remove any electrostatic charge that may be present on your body. There is a danger of this product getting damaged due to the electrostatic charge.

The flexible wire-saving system **SUNX S-LINK V** are not mutually interchangeable with the sensor & wire-saving link system **SUNX S-LINK** and cannot be mixed and matched. Please exercise caution.

〔 Nevertheless, any of the exclusive 4-core flat cable, connectors, hook-up pliers, or **SL-T8PW** 8-branch connector taps can be used. 〕

Please make use of this system's 'User's Manual'

For more detailed information pertaining to the flexible wire-saving system **SUNX S-LINK V**, please refer to its detailed 'User's Manual'.

It contains valuable information useful for when designing and laying out the system (specifications, exterior dimension illustrations, cautionary items for installation as well as for startup, troubleshooting, etc.) so please ask for it from your SUNX sales representative.

