

Cylinder Connections

Stainless Steel Compressed Gas Fittings and Assemblies



High Integrity, Value Priced:

Parker Hannifin Corporation's Veriflo Division, is committed to manufacturing and supplying high integrity CGA and ultra high integrity (DISS) connections to meet your instrument, analyzer and process high purity/specialty cylinder gas management needs.

The Veriflo cylinder connection offering includes:

- Nipples • Nuts • Gaskets
- Adapters • Caps • Plugs
- Assemblies • Seal Enhancers
- Flexible Pigtails • Torque Wrenches

The technical expertise involved in the development of each component ensures integrity of each connection.



Contact Information:

Parker Hannifin Corporation
Veriflo Division
250 Canal Blvd
Richmond, California 94804

phone 510 235 9590
fax 510 232 7396
veriflo.sales@parker.com

www.parker.com/veriflo

Product Features:

- 100% Visual inspection of critical surfaces.
- Cleaned and packaged for O₂ service.
- High and Ultra High integrity components.
- Available in stainless steel
- Patented Seal Enhancer improves connection integrity
- Gas Tight connections available.
- Gaskets available in PCTFE, Aluminum and Nickel



ENGINEERING YOUR SUCCESS.

Table of Contents:

53 Series: Valve Outlet Plugs and Caps	3
54 Series: Inlet Connections	4
56 Series: Inlet Connection Components (Nipple, Nuts & Washers).....	5
57 Series: Outlet Adapters, Blank Caps and Plugs.....	8
58 Series: Pigtail Connections	10
Seal Enhancers:	11
Gaskets and Washers:	11
Flexible Pigtails:	12
Torque Wrenches: 77 Series	12
Materials of Construction	12
Gas Connection Assignment Table	13

Specifications:

High Integrity	
<ul style="list-style-type: none"> Cleaned for O₂ service 100% visual inspection of critical surfaces Poly-bagged 	
Materials of Construction	
Wetted	
Nipples	316/316L Stainless Steel
Outlet Adapters	316L Stainless Steel
Cylinder Valve Outlet Caps	Stainless Steel
Washer	PCTFE/PTFE
Non-wetted	
Nuts	303/316 Stainless Steel

Ultra High Integrity (DISS)	
<ul style="list-style-type: none"> Cleaned for Ultra High Purity service Electropolished internally 9 Ra internal surface finish 100% visual inspection of critical surfaces Clean room packaged 	
Materials of Construction	
Wetted	
Nipples	SEMI F20 316L Stainless Steel
Outlet Adapters	316L Stainless Steel
Cylinder Valve Outlet Caps	Stainless Steel
Gaskets	Nickel (Std) <i>Consult factory for other materials</i>
Non-wetted	
Nuts	303 Stainless Steel with silver plated threads and bearing surfaces

All dimensions are in inches, are for reference only, and are subject to change.
For additional information on materials of construction, functional performance and operating conditions, please contact factory.

CGA Valve Outlet Plugs & Caps (Includes Ring and Chain)

53 Series

High Integrity for high purity-specialty gases in Instrument/Analyzer and Process Applications

CGA Number	Model Number	Part Number	Material	F Hex Flat	S Hex Flat	H Length	Gas-Tight*
320, 326, 346	53-30C-3PR	44800681	Stainless Steel with Polyethylene disc	1"	—	0.54"	No
330	53-33C-3PR	44800331	Stainless Steel with Polyethylene disc	1"	—	0.54"	No
350	53-350GTC-3R	44800430	Stainless Steel	1-1/8"	—	0.82"	Yes
510	53-510P-3TR	44800584	Stainless Steel with PTFE O-Ring	—	3/8"	1"	Yes
580	53-580P-3TR	44800218	Stainless Steel with PTFE O-Ring	—	3/8"	1"	Yes
590	53-590P-3TR	44803061	Stainless Steel with PTFE O-Ring	—	3/8"	1"	Yes
660	53-660C-3PR	44800073	Stainless Steel with Polyethylene disc	1-1/4"	—	0.54"	No
670, 677, 678 or 679	53-67C-3PR	44800137	Stainless Steel with Polyethylene disc	1-1/4"	—	0.54"	No
705	53-705C-3PR	44803739	Stainless Steel with Polyethylene disc	1-3/8"	—	0.54"	No

53 Series

Ultra High Integrity for high purity-specialty gases in Microelectronics and other UHP Process Applications

CGA/ DISS Number	Model Number	Part Number	Material	F Hex Flat	S Hex Flat	H Length	Gas-Tight*
632, 634, 636, 638, 640 or 642	53-63GTC-2NR	44800016	Stainless Steel with Nickel gasket	1-1/4"	—	0.98"	Yes
712, 714, 716, 718, 720, 722, 724, 726 or 728	53-71GTC-2NR	44800032	Stainless Steel with Nickel gasket	1-3/8"	—	0.98"	Yes

* Components not rated Gas-Tight are intended only to keep valve outlets clean and provide protection to threads. They must not be relied on to contain pressure if the valve leaks or is inadvertently opened.

CGA Cap
320-350 & 660-705

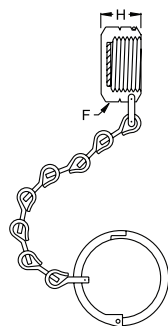

CGA Plug
510, 580 & 590

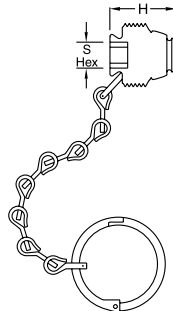

UHP CGA Plug
632-642 & 712-728

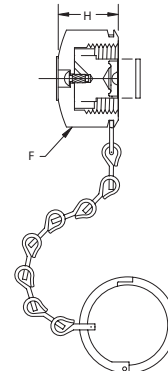

CGA Inlet Connections (Includes Nipple, Nut, and Gasket)

54 Series

Ultra High Integrity assemblies for high purity-specialty gases in Microelectronics and other UHP Process Applications

CGA/ DISS Number	End Connection	H Overall Length	Model Number	Part Number	F Flat Hex
632	1/4" Auto Tube Weld	2-1/2"	54-632-4TW2-N	44800092	1-1/4"
	1/4" Vac Male	3"	54-632-4VM2-N	44800146	
634	1/4" Auto Tube Weld	2-1/2"	54-634-4TW2-N	44800049	1-1/4"
	1/4" Vac Male	3"	54-634-4VM2-N	44800217	
636	1/4" Auto Tube Weld	2-1/2"	54-636-4TW2-N	44800299	1-1/4"
	1/4" Vac Male	3"	54-636-4VM2-N	44800336	
638	1/4" Auto Tube Weld	2-1/2"	54-638-4TW2-N	44800136	1-1/4"
	1/4" Vac Male	3"	54-638-4VM2-N	44800272	
640	1/4" Auto Tube Weld	2-1/2"	54-640-4TW2-N	44800084	1-1/4"
	1/4" Vac Male	3"	54-640-4VM2-N	44800039	
642	1/4" Auto Tube Weld	2-1/2"	54-642-4TW2-N	44800054	1-1/4"
	1/4" Vac Male	3"	54-642-4VM2-N	44800161	
712	1/4" Auto Tube Weld	2-1/2"	54-712-4TW2-N	44800186	1-3/8"
	1/4" Vac Male	3"	54-712-4VM2-N	44800193	
714	1/4" Auto Tube Weld	2-1/2"	54-714-4TW2-N	44800350	1-3/8"
	1/4" Vac Male	3"	54-714-4VM2-N	44800499	
716	1/4" Auto Tube Weld	2-1/2"	54-716-4TW2-N	44800038	1-3/8"
	1/4" Vac Male	3"	54-716-4VM2-N	44800155	
718	1/4" Auto Tube Weld	2-1/2"	54-718-4TW2-N	44800041	1-3/8"
	1/4" Vac Male	3"	54-718-4VM2-N	44800098	
720	1/4" Auto Tube Weld	2-1/2"	54-720-4TW2-N	44800144	1-3/8"
	1/4" Vac Male	3"	54-720-4VM2-N	44800065	
722	1/4" Auto Tube Weld	2-1/2"	54-722-4TW2-N	44801163	1-3/8"
	1/4" Vac Male	3"	54-722-4VM2-N	44803517	
724	1/4" Auto Tube Weld	2-1/2"	54-724-4TW2-N	44800201	1-3/8"
	1/4" Vac Male	3"	54-724-4VM2-N	44800205	
726	1/4" Auto Tube Weld	2-1/2"	54-726-4TW2-N	44800417	1-3/8"
	1/4" Vac Male	3"	54-726-4VM2-N	44803182	
728	1/4" Auto Tube Weld	2-1/2"	54-728-4TW2-N	44800751	1-3/8"
	1/4" Vac Male	3"	54-728-4VM2-N	44800368	

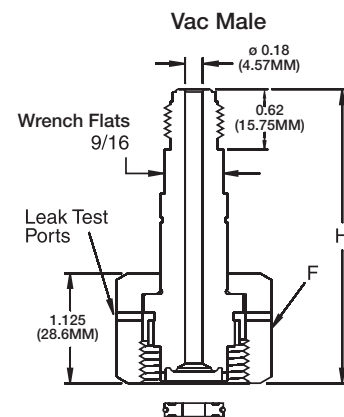
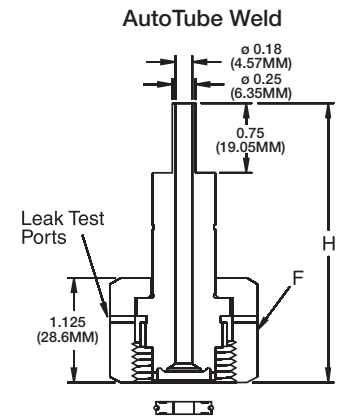

All Inlet Connections include nickel gasket 50-63-NI.
Nickel gasket is available in a 25 pack under part number 44803595.

CGA Inlet Connection Components

Nipples, Nuts, and Washers

56 Series

High Integrity for high purity-specialty gases in Instrument/Analyzer and Process Applications

CGA Number	End Connection	H Overall Length	Nipple Model Number	Nipple Part Number	Nut Model Number	Nut Part Number	F1 Flat Hex	Washer Model Number**	Washer Part Number*
170	1/4" Auto Tube Weld	1-1/4"	56-170-4TW2-P	44803332	55-170-3	44800264	11/16"	50-170-T	44803474
	1/8" NPT Male	1-1/4"	56-170-2M2-20	44800891				50-170-K	44803475
180	1/4" Auto Tube Weld	1-1/4"	56-180-4TW2-P	44803336	55-180-3	44800139	3/4"	50-180-T	44803476
	1/8" NPT Male	1-3/4"	56-180-2M2-28	44800162				50-180-K	44803547
290	1/4" Auto Tube Weld	2-5/8"	56-290-4TW2-P	44803733	55-290-3	44800726	1"	N/A	N/A
	1/4" NPT Male	2-1/4"	56-290-4M2-36	44800724					
296	1/4" Auto Tube Weld	2-5/8"	56-296-4TW2-P	44800661	55-296-3	44800333	7/8"	N/A	N/A
	1/4" Vac Male	2-3/4"	56-296-4VM2-P	44803605					
	1/4" NPT Male	3-1/2"	56-296-4M2-56	44800385					
320	1/4" Auto Tube Weld	1-3/4"	56-32-4TW2-P	44800083	55-320-3	44800219	1-1/8"	50-320-T	44803477
	1/4" Vac Male	1-3/4"	56-32-4VM2-P	44800199					
	1/4" Auto Tube Weld	2-1/2"	56-32-4TW2-40-P	44803734				50-320-K	44803478
	1/4" NPT Male	2-1/2"	56-32-4M2-40	44800322					
	1/4" NPT Male	4"	56-32-4M2-64	44803728					
326	1/4" Auto Tube Weld	2-1/4"	56-326-4TW2-P	44800307	55-326-3	44800306	1-1/8"	N/A	See Seal Enhancers
	1/4" Vac Male	2-1/4"	56-326-4VM2-P	44800493					
	1/4" NPT Male	3"	56-326-4M2-48	44800343					
330	1/4" Auto Tube Weld	1-3/4"	56-32-4TW2-P	44800083	55-330-3	44800108	1-1/8"	50-320-T	44803477
	1/4" Vac Male	1-3/4"	56-32-4VM2-P	44800199					
	1/4" Auto Tube Weld	2-1/2"	56-32-4TW2-40-P	44803734				50-320-K	44803478
	1/4" NPT Male	2-1/2"	56-32-4M2-40	44800322					
	1/4" NPT Male	4"	56-32-4M2-64	44803728					
346	1/4" Auto Tube Weld	2-5/16"	56-346-4TW2-P	44803631	55-346-3	44800395	1-1/8"	N/A	See Seal Enhancers
	1/4" Vac Male	2-1/4"	56-346-4VM2-P	44803738					
	1/4" NPT Male	3"	56-346-4M2-48	44800414					
350	1/4" Auto Tube Weld	2-5/16"	56-350-4TW2-P	44800128	55-350-3	44800078	1-1/8"	N/A	See Seal Enhancers
	1/4" Vac Male	2-1/4"	56-350-4VM2-P	44800234					
	1/4" Auto Tube Weld	2-1/2"	56-350-4TW2-40-P	44803735					
	1/4" NPT Male	3"	56-350-4M2-48	44800160					
	1/4" NPT Male	4"	56-350-4M2-64	44803729					

-P indicates internal surface finish of 9 Ra Electropolish

Electropolished I.D. components designated by the "-P" suffix are cleaned and packaged in a clean room.

* All gaskets sold in 25 pack.

** Washer numbers ending in "T" are PTFE and those ending in "K" are PCTFE.

CGA Inlet Connection Components *continued*

Nipples, Nuts, and Washers

56 Series

High Integrity for high purity-specialty gases in Instrument/Analyzer and Process Applications

CGA Number	End Connection	H Overall Length	Nipple Model Number	Nipple Part Number	Nut Model Number	Nut Part Number	F1 Flat Hex	Washer Model Number**	Washer Part Number*
510	1/4" Auto Tube Weld	2-5/8"	56-50-4TW2-P	44800044	55-510-3	44800292	1-1/8"	N/A	N/A
	1/4" Vac Male	2-3/4"	56-50-4VM2-P	44800043					
	1/4" Auto Tube Weld	2-1/2"	56-50-4TW2-40-P	44803736					
	1/4" NPT Male	3-1/2"	56-50-4M2-56	44800070					
	1/4" NPT Male	4"	56-50-4M2-64	44803730					
	1/4" NPT Male	4-1/2"	56-50-4M2-72	44803731					
540	1/4" Auto Tube Weld	2-1/4"	56-54-4TW2-P	44800257	55-540-3	44800188	1-1/8"	N/A	N/A
	1/4" Vac Male	2-1/4"	56-54-4VM2-P	44800422					
	1/4" NPT Male	3"	56-54-4M2-48	44800275					
555	1/4" Auto Tube Weld	2-1/4"	56-54-4TW2-P	44800257	55-555-3	44803175	1-1/8"	N/A	N/A
	1/4" Vac Male	2-1/4"	56-54-4VM2-P	44800422					
	1/4" NPT Male	3"	56-54-4M2-48	44800275					
580	1/4" Auto Tube Weld	2-5/8"	56-50-4TW2-P	44800044	55-580-3	44800027	1-1/8"	N/A	N/A
	1/4" Vac Male	2-3/4"	56-50-4VM2-P	44800043					
	1/4" Auto Tube Weld	2-1/2"	56-50-4TW2-40-P	44803736					
	1/4" NPT Male	3-1/2"	56-50-4M2-56	44800070					
	1/4" NPT Male	4"	56-50-4M2-64	44803730					
	1/4" NPT Male	4-1/2"	56-50-4M2-72	44803731					
590	1/4" Auto Tube Weld	2-5/8"	56-50-4TW2-P	44800044	55-590-3	44800173	1-1/8"	N/A	N/A
	1/4" Vac Male	2-3/4"	56-50-4VM2-P	44800043					
	1/4" Auto Tube Weld	2-1/2"	56-50-4TW2-40-P	44803736					
	1/4" NPT Male	3-1/2"	56-50-4M2-56	44800070					
	1/4" NPT Male	4"	56-50-4M2-64	44803730					
	1/4" NPT Male	4-1/2"	56-50-4M2-72	44803731					
660	1/4" Auto Tube Weld	2-3/16"	56-60-4TW2-P	44800159	55-660-3	44800123	1-1/4"	50-60-T	44803479
	1/4" Vac Male	1-7/8"	56-60-4VM2-P	44800082				50-60-K	44803480
	1/4" Auto Tube Weld	2-1/2"	56-60-4TW2-40-P	44803737					
	1/4" NPT Male	2-5/8"	56-60-4M2-42	44800273					
	1/4" NPT Male	4"	56-60-4M2-64	44803732					

-P indicates internal surface finish of 9 Ra Electropolish
Electropolished I.D. components designated by the "-P" suffix are cleaned and packaged in a clean room.

* All gaskets sold in 25 pack.

** Washer numbers ending in "T" are PTFE and those ending in "K" are PCTFE.

CGA Inlet Connection Components *continued*

Nipples, Nuts, and Washers

56 Series

High Integrity for high purity-specialty gases in Instrument/Analyzer and Process Applications

CGA Number	End Connection	H Overall Length	Nipple Model Number	Nipple Part Number	Nut Model Number	Nut Part Number	F1 Flat Hex	Washer Model Number**	Washer Part Number*
670	1/4" Auto Tube Weld	2-3/16"	56-60-4TW2-P	44800159	55-670-3	44800423	1-1/4"	50-60-T	44803479
	1/4" Vac Male	1-7/8"	56-60-4VM2-P	44800082					
	1/4" Auto Tube Weld	2-1/2"	56-60-4TW2-40-P	44803737					
	1/4" NPT Male	2-5/8"	56-60-4M2-42	44800273					
	1/4" NPT Male	4"	56-60-4M2-64	44803732					
678	1/4" Auto Tube Weld	2-1/2"	56-678-4TW2-P	44800470	55-678-3	44800387	1-1/4"	50-66-T	44803481
	1/4" Vac Male	2"	56-678-4VM2-P	44800508				50-66-K	44803482
	1/4" NPT Male	2-3/8"	56-678-4M2-38	44803514					
679	1/4" Auto Tube Weld	2-1/2"	56-679-4TW2-P	44800673	55-679-3	44800545	1-1/4"	50-110-T	44803472
	1/4" Vac Male	2"	56-679-4VM2-P	44803707					
	1/4" NPT Male	2-1/2"	56-679-4M2-40	44803624					

-P indicates internal surface finish of 9 Ra Electropolish

Electropolished I.D. components designated by the "-P" suffix are cleaned and packaged in a clean room.

* All gaskets sold in 25 pack.

** Washer numbers ending in "T" are PTFE and those ending in "K" are PCTFE.

**VacuSeal Male
CGA 330**

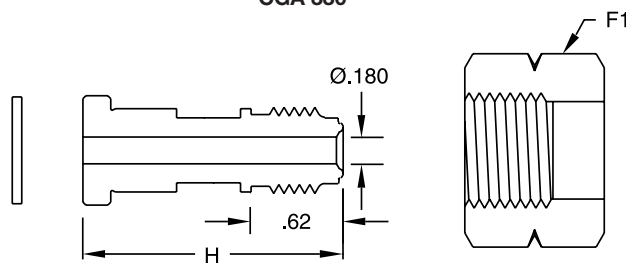

**Auto Tube Weld
CGA 330**

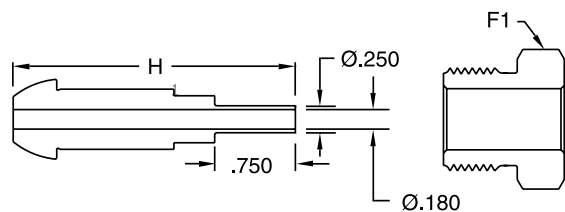

CGA Outlet Adapters, Blank Caps & Plugs

57 Series

High Integrity for high purity-specialty gases in Instrument/Analyzer and Process Applications

CGA Number	End Connection	Model Number	Part Number	H Overall Length	F2 Flat Hex
180	1/4" NPT Female	57-180M4F-2	44800409	1.38"	3/4"
	Blank Cap	57-296FXX-3	44800712	1.37"	
296	1/4" VacuSeal™ Male	57-296F4VM-2	44803297	2.00"	1-1/8"
	1/4" NPT Female	57-296F4F-2	44803438	2.00"	
320	Blank Plug	57-320MXX-3	44800374	1.12"	1"
	1/4" VacuSeal™ Male	57-320M4VM-2	44803070	1.74"	
	1/4" NPT Female	57-320M4F-2	44800265	1.12"	
326	Blank Plug	57-326MXX-3	44800543	1.12"	1"
	1/4" VacuSeal™ Male	57-326M4VM-2	44800740	1.74"	
	1/4" NPT Female	57-326M4F-2	44800713	1.31"	
330	Blank Plug	57-330MXX-3	44800269	1.12"	1"
	1/4" VacuSeal™ Male	57-330M4VM-2	44800567	1.74"	
346	1/4" NPT Female	57-330M4F-2	44800203	1.31"	1"
	Blank Plug	57-346MXX-3	44803441	1.12"	
	1/4" VacuSeal™ Male	57-346M4VM-2	44803440	1.88"	
350	1/4" NPT Female	57-346M4F-2	44803439	1.31"	1"
	Blank Plug	57-350MXX-3	44800164	1.12"	
	1/4" VacuSeal™ Male	57-350M4VM-2	44800308	1.88"	
510	1/4" NPT Female	57-350M4F-2	44800358	1.31"	1"
	Blank Cap	57-510FXX-3	44800740	1.37"	
540	1/4" VacuSeal™ Male	57-510F4VM-2	44800510	2.00"	1-1/4"
	1/4" NPT Female	57-510F4F-2	44800599	2.00"	
	Blank Plug	57-540MXX-3	44800436	1.12"	
580	1/4" VacuSeal™ Male	57-540M4VM-2	44800411	1.87"	1"
	1/4" NPT Female	57-540M4F-2	44800685	1.25"	
	Blank Cap	57-580FXX-3	44800122	1.37"	
590	1/4" VacuSeal™ Male	57-580F4VM-2	44800238	2.00"	1-1/4"
	1/4" NPT Female	57-580F4F-2	44800214	2.00"	
660	Blank Cap	57-590FXX-3	44800317	1.37"	1-1/4"
	1/4" VacuSeal™ Male	57-590F4VM-2	44800592	2.00"	
	1/4" NPT Female	57-590F4F-2	44800487	2.00"	
670	Blank Plug	57-660MXX-3	44800226	0.88"	1-1/8"
	1/4" VacuSeal™ Male	57-660M4VM-2	44800444	1.50"	
	1/4" NPT Female	57-660M4F-2	44800097	1.25"	
678	Blank Plug	57-670MXX-3	44800664	0.88"	1-1/8"
	1/4" VacuSeal™ Male	57-670M4VM-2	44800477	1.50"	
	1/4" NPT Female	57-670M4F-2	44800711	1.25"	
679	Blank Plug	57-678MXX-3	44800671	1.00"	1-1/8"
	1/4" VacuSeal™ Male	57-678M4VM-2	44800565	1.50"	
699	Blank Plug	57-679MXX-3	44800708	0.88"	1-1/8"
	1/4" VacuSeal™ Male	57-679M4VM-2	44800315	1.75"	
	1/4" NPT Female	57-679M4F-2	44800570	1.25"	

Blank Cap
CGA 580

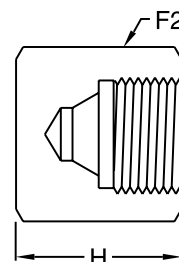

Blank Plug
CGA 350

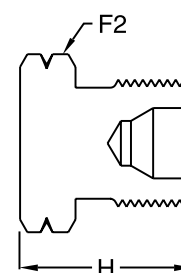

Vac Male
CGA 350

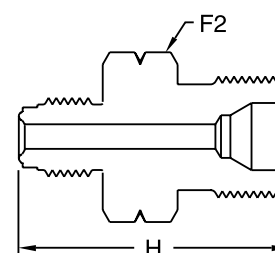

NPT Female
CGA 350

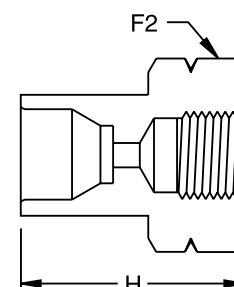

CGA Outlet Adapters and Blank Plugs

57 Series

Ultra High Integrity for high purity-specialty gases in Microelectronics and other UHP Process Applications

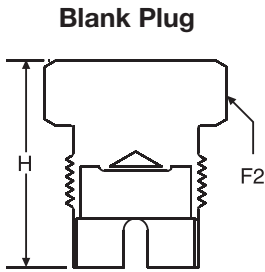

Blank Plug

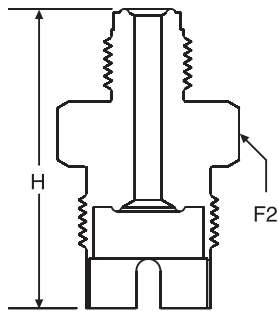

Vac Male

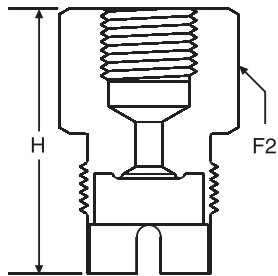

NPT Female

CGA/ DISS Number	End Connection	Model Number	Part Number	H Overall Length	F2 Flat Hex
632	Blank Valve Outlet Adapter	57-63MXX-2	44800013	1.53"	1-1/8"
	1/4" VacuSeal™ Male	57-632M4VM-2	44800349	2"	
	1/4" NPT Female	57-632M4F-2	44800361	1.85"	
634	Blank Valve Outlet Adapter	57-63MXX-2	44800013	1.53"	1-1/8"
	1/4" VacuSeal™ Male	57-634M4VM-2	44800420	2"	
	1/4" NPT Female	57-634M4F-2	44803363	1.85"	
636	Blank Valve Outlet Adapter	57-63MXX-2	44800013	1.53"	1-1/8"
	1/4" VacuSeal™ Male	57-636M4VM-2	44800445	2"	
	1/4" NPT Female	57-636M4F-2	44803449	1.85"	
638	Blank Valve Outlet Adapter	57-63MXX-2	44800013	1.53"	1-1/8"
	1/4" VacuSeal™ Male	57-638M4VM-2	44800483	2"	
	1/4" NPT Female	57-638M4F-2	44803359	1.85"	
640	Blank Valve Outlet Adapter	57-63MXX-2	44800013	1.53"	1-1/8"
	1/4" VacuSeal™ Male	57-640M4VM-2	44800294	2"	
	1/4" NPT Female	57-640M4F-2	44800383	1.85"	
642	Blank Valve Outlet Adapter	57-63MXX-2	44800013	1.53"	1-1/8"
	1/4" VacuSeal™ Male	57-642M4VM-2	44800618	2"	
	1/4" NPT Female	57-642M4F-2	44800595	1.85"	
712	Blank Valve Outlet Adapter	57-70MXX-2	44800113	1.53"	1-1/4"
	1/4" VacuSeal™ Male	57-712M4VM-2	44800291	2"	
	1/4" NPT Female	57-712M4F-2	44800354	1.85"	
714	Blank Valve Outlet Adapter	57-70MXX-2	44800113	1.53"	1-1/4"
	1/4" VacuSeal™ Male	57-714M4VM-2	44800375	2"	
716	Blank Valve Outlet Adapter	57-70MXX-2	44800113	1.53"	1-1/4"
	1/4" VacuSeal™ Male	57-716M4VM-2	44800192	2"	
	1/4" NPT Female	57-716M4F-2	44800211	1.85"	
718	Blank Valve Outlet Adapter	57-70MXX-2	44800113	1.53"	1-1/4"
	1/4" VacuSeal™ Male	57-718M4VM-2	44800324	2"	
	1/4" NPT Female	57-718M4F-2	44803360	1.85"	
720	Blank Valve Outlet Adapter	57-72MXX-2	44800125	1.53"	1-1/4"
	1/4" VacuSeal™ Male	57-720M4VM-2	44800482	2"	
	1/4" NPT Female	57-720M4F-2	44800634	1.85"	
722	Blank Valve Outlet Adapter	57-72MXX-2	44800125	1.53"	1-1/4"
	1/4" VacuSeal™ Male	57-722M4VM-2	44800617	2"	
	1/4" NPT Female	57-722M4F-2	44800651	1.85"	
724	Blank Valve Outlet Adapter	57-72MXX-2	44800125	1.53"	1-1/4"
	1/4" VacuSeal™ Male	57-724M4VM-2	44800364	2"	
	1/4" NPT Female	57-724M4F-2	44803361	1.85"	
726	Blank Valve Outlet Adapter	57-72MXX-2	44800125	1.53"	1-1/4"
	1/4" VacuSeal™ Male	57-726M4VM-2	44800616	2"	
728	Blank Valve Outlet Adapter	57-72MXX-2	44800125	1.53"	1-1/4"
	1/4" VacuSeal™ Male	57-728M4VM-2	44800355	2"	
	1/4" NPT Female	57-728M4F-2	44803362	1.85"	

CGA Pigtail Connections

58 Series

High Integrity for high purity-specialty gases in Instrument/Analyzer and Process Applications

CGA Number	Drawing	Model Number	Part Number	H Overall Length	F1 Hex Flat	F2 Hex Flat	Washer Material
296	B	58-296-4TW2-P	44800293	3.03	7/8"	1-1/8"	—
320	A	58-320-4TW2-P	44800178	2.96	1-1/8"	1"	PCTFE
326	A	58-326-4TW2-P	44800168	3.01	1-1/8"	1"	—
330	A	58-330-4TW2-P	44800072	2.96	1-1/8"	1"	PCTFE
346	A	58-346-4TW2-P	44803741	2.97	1-1/8"	1"	—
350	A	58-350-4TW2-P	44800028	2.96	1-1/8"	1"	—
510	B	58-510-4TW2-P	44800432	3.03	1-1/8"	1-1/4"	—
540	A	58-540-4TW2-P	44800129	2.96	1-1/8"	1"	—
555	A	58-555-4TW2-P	44803742	2.96	1-1/8"	1"	—
580	B	58-580-4TW2-P	44800021	3.03	1-1/8"	1-1/4"	—
590	B	58-590-4TW2-P	44800147	3.03	1-1/8"	1-1/4"	—
660	A	58-660-4TW2-P	44800068	2.96	1-1/4"	1-1/8"	PCTFE
670	A	58-670-4TW2-P	44800424	2.96	1-1/4"	1-1/8"	PCTFE
678	A	58-678-4TW2-P	44800428	3.08	1-1/4"	1-1/8"	PCTFE
679	A	58-679-4TW2-P	44800237	2.96	1-1/4"	1-1/8"	PTFE

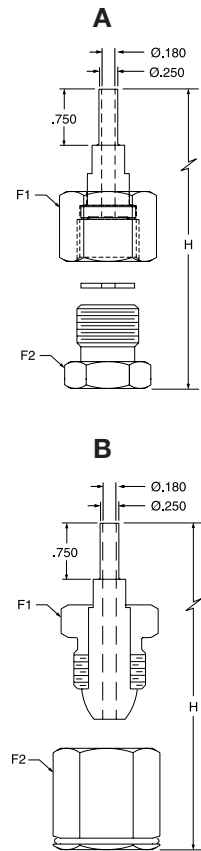

Electropolished I.D. components designated by the “-P” suffix are cleaned and packaged in a clean room.
 -P indicates internal surface finish of 9 Ra Electropolish

58 Series

Ultra High Integrity for high purity-specialty gases in Microelectronics and other UHP Process Applications

CGA/ DISS Number	Model Number	Part Number	H Overall Length	F1 Hex Flat	F2 Hex Flat
632	58-632-4TW2	44800008	3.40	1-1/4"	1-1/8"
634	58-634-4TW2	44800012	3.40	1-1/4"	1-1/8"
636	58-636-4TW2	44800034	3.40	1-1/4"	1-1/8"
638	58-638-4TW2	44800024	3.40	1-1/4"	1-1/8"
640	58-640-4TW2	44800020	3.40	1-1/4"	1-1/8"
642	58-642-4TW2	44800107	3.40	1-1/4"	1-1/8"
712	58-712-4TW2	44800031	3.40	1-3/8"	1-1/4"
714	58-714-4TW2	44800045	3.40	1-3/8"	1-1/4"
716	58-716-4TW2	44800011	3.40	1-3/8"	1-1/4"
718	58-718-4TW2	44800009	3.40	1-3/8"	1-1/4"
720	58-720-4TW2	44800019	3.40	1-3/8"	1-1/4"
722	58-722-4TW2	44800216	3.40	1-3/8"	1-1/4"
724	58-724-4TW2	44800030	3.40	1-3/8"	1-1/4"
726	58-726-4TW2	44800321	3.40	1-3/8"	1-1/4"
728	58-728-4TW2	44800017	3.40	1-3/8"	1-1/4"

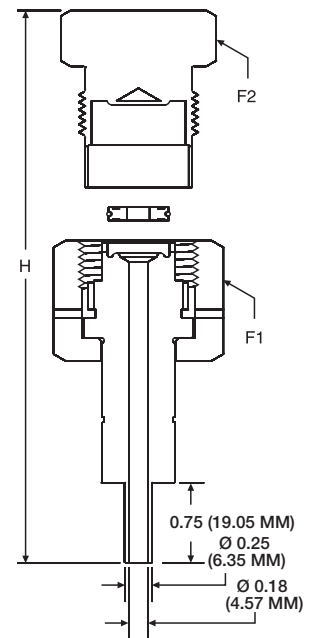

All Ultra High Integrity Pigtail Connections include nickel gasket

Seal Enhancers

(10 Per Package)

Material	Model Number	Part Number	A Overall Length	B Overall Length	C Overall Length	D Overall Length
Nickel 200	50-326-NI	44801258	.54	.45	.22	.43
Nickel 200	50-346-NI	44801077	.62	.54	.29	.50
Nickel 200	50-350-NI	44801079	.62	.54	.29	.50

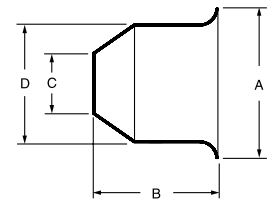

Gaskets & Washers

(25 Per Package)

High Integrity for high purity-specialty gases in Instrument/Analyzer and Process Applications

CGA Number	Material	Model Number	Part Number	A Overall Length	H Overall Width	E Overall Bore
170	PTFE	50-170-T	44803474	.425	.1	.187
170	PCTFE	50-170-K	44803475	.425	.1	.187
180	PTFE	50-180-T	44803476	.437	.094	.320
180	PCTFE	50-180-K	44803547	.437	.094	.320
320, 330	PTFE	50-320-T	44803477	.703	.094	.250
320, 330	PCTFE	50-320-K	44803478	.718	.064	.265
660, 670	PTFE	50-60-T	44803479	.938	.063	.383
660, 670	PCTFE	50-60-K	44803480	.937	.062	.375
678	PTFE	50-66-T	44803481	.609	.062	.295
678	PCTFE	50-66-K	44803482	.609	.062	.295
679	PTFE	50-110-T	44803472	.531	.063	.312

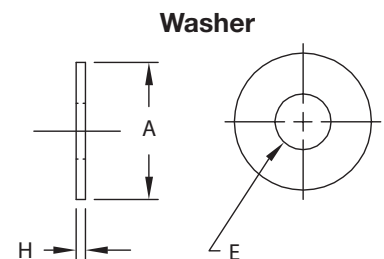

Ultra High Integrity for high purity-specialty gases in Microelectronics and other UHP Process Applications

CGA/DISS Number	Material	Model Number	Part Number	A Overall Length	H Overall Width	E Overall Bore
632-728	Nickel 200	50-63-NI	44803595	.56	.105	.21
632-728	PCTFE	50-63-K	44803412	.56	.105	.21
632-728	Aluminum	50-63-AL	44803469	.56	.105	.25

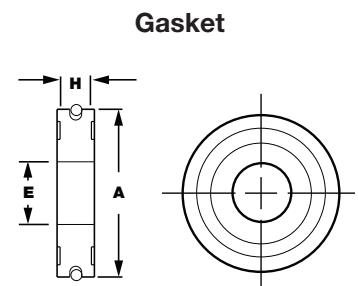

Flexible Pigtails

Part Number	Material	End Connections	H Overall Length	Maximum Working Pressure
44803751	316 Double Braided Stainless Steel Hose	1/4" MNPT x 1/4" FNPT	12"	3625 PSI
44803752	316 Double Braided Stainless Steel Hose	1/4" MNPT x 1/4" FNPT	24"	3625 PSI
44803753	316 Double Braided Stainless Steel Hose	1/4" MNPT x 1/4" FNPT	36"	3625 PSI
44803754	316 Double Braided Stainless Steel Hose	1/4" MNPT x 1/4" FNPT	48"	3625 PSI
44803755	316 Double Braided Stainless Steel Hose	1/4" MNPT x 1/4" FNPT	60"	3625 PSI
44803756	316 Double Braided Stainless Steel Hose	1/4" MNPT x 1/4" FNPT	72"	3625 PSI

Torque Wrenches

77 Series

Torque Wrenches

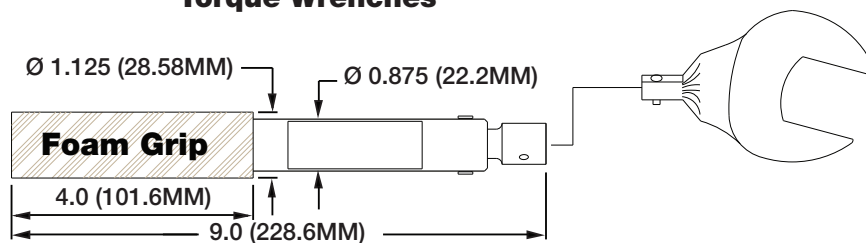

Model Number	Part Number	Factory Set Torque	For Use With	CGA 632-642 Hex Flat	CGA 712-718 Hex Flat	CGA 326, 346, 350 Hex Flat
77-DISS-TW	44800010	35 ft-lbs	Nickel Gasket	1-1/4"	1-3/8"	N/A
77-DISS-TW-K	44800035	12 ft-lbs	PCTFE Gasket			
77-350-TW	44803230	40 ft-lbs	Nickel Seal Enhancers	N/A	N/A	1-1/8"

Torque wrenches are specifically designed for use with the Compressed Gas Association's CGA 632-642, 712-728 and CGA 326, 346 and 350 series of connections. Torque is factory set to the CGA recommendations. Calibration service is also available and is recommended every six months or 4,000 cycles, whichever comes first.

Notes:

CGA (Compressed Gas Association) connections are adapter fittings designed to connect a cylinder of compressed gas to either a regulator, pigtail, hose assembly, etc.

Each CGA Series (I.E. 580, 590, 660) has a unique design which will only "mate" with the corresponding cylinder connection.

The unique design of each CGA series impedes an operator from mixing gases that may not be compatible.

Each CGA series is specific to a given gas, family of compatible gases and/or cylinder pressures.

The Customer is responsible for specifying the proper CGA connection for his/her application.

The guidelines set forth by the Compressed Gas Association must be followed to insure that gases are not mixed and the proper connection is used for the pressure range of the cylinder.

Actual gas assignments are subject to periodic change. The user must verify all information at the time of use. For verification, please contact the Compressed Gas Association.

Note: Adapters that allow conversion of one type of gas connection to another are dangerous & can result in a fire and/or personnel injury.

Gas Connection Assignment Table**

For pressures up to 4704 psig (320 bar) dependent of CGA, DIN, JIS and ISO organization specifications.

Gas	Formula	UHP CGA	CGA	DIN	JIS
Ammonia	NH ₃	720	705	DIN 6	22-R
Argon	Ar	718	580	DIN 6	22-R or 23-R
Arsenic Pentafluoride	AsF ₅	642	-	-	-
Arsine	AsH ₃	632	350	-	22-L
Boron Trichloride	BCl ₃	634	660	DIN 8	-
Boron Trifluoride	BF ₃	642	330	DIN 8	22-L
Carbon Dioxide	CO ₂	716	320	DIN 6	-
Carbon Monoxide	CO	724	350	DIN 5	22-L
Chlorine	Cl ₂	728	-	DIN 8	26-R
Diborane	B ₂ H ₆	632	350	-	22-L
Dichlorosilane	SiH ₂ Cl ₂	636	678*	DIN 5	-
Diethylzinc	Zn(C ₂ H ₅) ₂	726	510*	-	-
Diethyltelluride	(C ₂ H ₅) ₂ Te	726	-	-	-
Dimethylzinc	(CH ₃) ₂ Zn	726	-	-	-
Disilane	Si ₂ H ₆	632	-	-	-
Germane	GeH ₄	632	350 or 660	-	-
Halocarbon 11	CCl ₃ F	716	660	-	-
Halocarbon 115	ClCF ₂ CF ₃	716	660	DIN 6	-
Halocarbon 12	CCl ₂ F ₂	716	660	DIN 6	-
Halocarbon 13	ClCF ₃	716	660	DIN 6	-
Halocarbon 14	CF ₄	716	320 or 580	DIN 6	-
Halocarbon 23	CHF ₃	716	660	DIN 6	-
Halocarbon 116	F ₃ CCF ₃	716	660	-	-
Helium	He	718	580	DIN 6	22-R OR 23-R
Hydrogen	H ₂	724	350	DIN 1	22-L
Hydrogen Bromide	HBr	634	330	DIN 8	26-R
Hydrogen Chloride	HCl	634	330	DIN 8	26-R
Hydrogen Fluoride	HF	638	660 or 670	-	26-R
Hydrogen Sulfide	H ₂ S	722	330	DIN 5	-
Krypton	Kr	718	580	DIN 6	22-R OR 23-R
Neon	Ne	718	580	DIN 6	22-R OR 23-R
Nitrogen	N ₂	718	580	DIN 10	22-R OR 23-R
Nitrogen Trifluoride	NF ₃	640	330 or 670	DIN 8	-
Nitrous Oxide	N ₂ O	712	326	DIN 8	-
Oxygen	O ₂	714	540	DIN 9	22-R OR 23-R
Perfluoropropane	CF ₂ (CF ₃) ₂	716	660	-	-
Phosphine	PH ₃	632	350 or 660	DIN 1	-
Phosphorus Pentafluoride	PF ₅	642	330 or 660	-	-
Silane	SiH ₄	632	350	-	-
Silicon Tetrachloride	SiCl ₄	636	-	-	-
Silicon Tetrafluoride	SiF ₄	642	330	-	22-L
Sulphur Hexafluoride	SF ₆	716	590	DIN 6	26-R
Trichlorosilane	SiHCl ₃	636	-	-	-
Triethylaluminum	(C ₂ H ₅) ₃ Al	726	510*	-	-
Tungsten Hexafluoride	WF ₆	638	670	DIN 8	-
Xenon	Xe	718	580	DIN 6	22-R

* Consult CGA, DIN, JIS, or ISO organization specifications for pressure limits.

** Information in this table was obtained from reliable sources. It shall be used for reference only. Actual gas assignments are subject to periodic change and may differ based on pressure range. The user must verify all information in this table at the time of use. For verification, contact the Compressed Gas Association offices.

System Notes *continued*

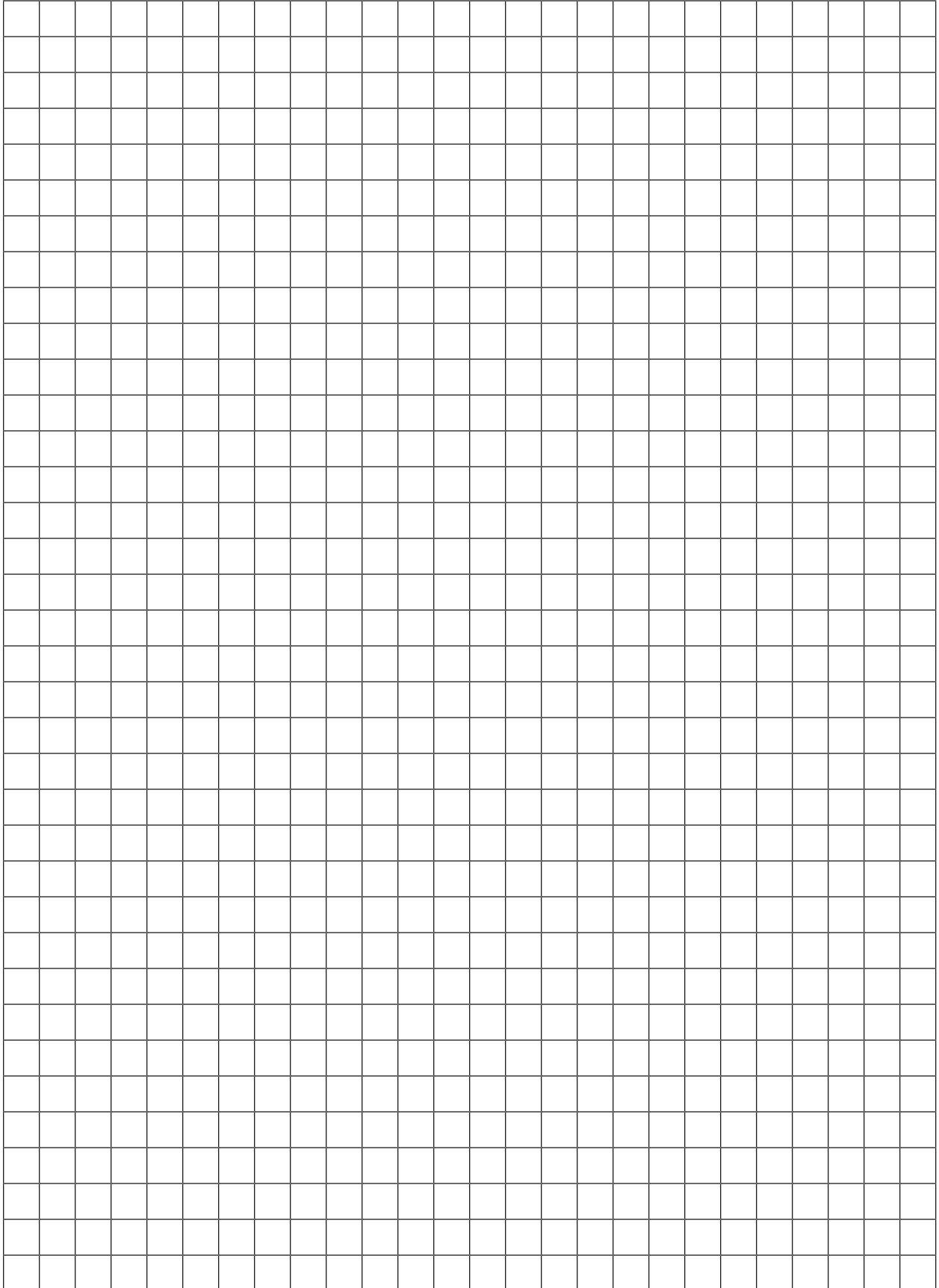

OFFER OF SALE:

The items described in this document are hereby offered for sale by Parker-Hannifin Corporation, its subsidiaries or its authorized distributors. This offer and its acceptance are governed by the provisions stated in the detailed "Offer of Sale" elsewhere in this document or available at www.parker.com/veriflo

 **WARNING USER RESPONSIBILITY**

FAILURE OR IMPROPER SELECTION OR IMPROPER USE OF THE PRODUCTS DESCRIBED HEREIN OR RELATED ITEMS CAN CAUSE DEATH, PERSONAL INJURY AND PROPERTY DAMAGE. THIS DOCUMENT IS FOR REFERENCE ONLY. PLEASE CONSULT FACTORY FOR LATEST PRODUCT DRAWINGS AND SPECIFICATIONS

This document and other information from Parker-Hannifin Corporation, its subsidiaries and authorized distributors provide product or system options for further investigation by users having technical expertise.

The user, through its own analysis and testing, is solely responsible for making the final selection of the system and components and assuring that all performance, endurance, maintenance, safety and warning requirements of the application are met. The user must analyze all aspects of the application, follow applicable industry standards, and follow the information concerning the product in the current product catalog and in any other materials provided from Parker or its subsidiaries or authorized distributors.

To the extent that Parker or its subsidiaries or authorized distributors provide component or system options based upon data or specifications provided by the user, the user is responsible for determining that such data and specifications are suitable and sufficient for all applications and reasonably foreseeable uses of the components or systems.



ENGINEERING YOUR SUCCESS.