

Orientalmotor

RoHS RoHS-Compliant
2-Phase Stepping Motors

PK Series































Stepping motors enable accurate positioning operation with ease.

They are used in various types of equipment for accurate rotation angle and speed control using pulse signals. In addition to the standard type (1.8°/step), we offer a high-torque type, a high-resolution type (0.9°/step) and three various geared types. And we newly provide a high-efficiency type that has a half heat generation of our conventional model.

Optimal motor can be selected from a wide range of our motor variations.

Wide Range of Motor Variations

Type	Step Angle	Additional Function	Features	Motor Frame Size							
				□28 mm	□35 mm	□42 mm	□50 mm	□56.4 mm	□60 mm	□85 mm	
High-Efficiency Type	1.8° /step	-	<ul style="list-style-type: none"> · Adopting high-efficiency technology · Low heat generation (50% less from our conventional model) · Low power consumption (31% less from our conventional model) 								
					P.14						
High-Torque Type	1.8° /step	-	<ul style="list-style-type: none"> · Compact & high-torque design · Connector equipped (Except □60 mm motor) 								
			P.8	P.12	P.16		P.38	P.55			
		Encoder Equipped	<ul style="list-style-type: none"> · 3-channel output encoder equipped · Resolution: 200 P/R, 400 P/R · Enables a high-accurate position detection 								
						P.17					
Standard Type	1.8° /step	-	<ul style="list-style-type: none"> · Basic model which offers balanced performance enhances by high torque, low vibration and low noise. 								
							P.19	P.36	P.40		P.64
		IP54 Rated Motor with Cable	<ul style="list-style-type: none"> · Degree of protection: IP54 (Excluding the installation surface) · Multi-core cable is adopted to a motor cable 								
								P.46		P.66	
		IP65 Rated Motor with Terminal Box	<ul style="list-style-type: none"> · Terminal box is suited protection against dust and water · Conforms to IP65 standard (Excluding the gap between the shaft and the flange) 								
								P.48		P.68	
		Encoder Equipped	<ul style="list-style-type: none"> · 3-channel output encoder equipped · Resolution: 200 P/R, 400 P/R · Enables a high-accurate position detection 								
						P.20		P.41			
High-Resolution Type	0.9° /step	-	<ul style="list-style-type: none"> · The step angle is half of the standard model · High stopping accuracy · Effective for low vibration 								
							P.24		P.50		
		Encoder Equipped	<ul style="list-style-type: none"> · 3-channel output encoder equipped · Resolution: 400 P/R · Enables a high-accurate position detection 								
						P.25		P.51			

Type	Additional Functions	Features	Gearhead Frame Size			
			□28 mm	□42 mm	□60 mm	□90 mm
PL Geared Type	—	<ul style="list-style-type: none"> · Gearhead assembled to motor · Low backlash gear with planetary gear mechanism · Permissible torque: 8 N·m (□60 mm) · Backlash: 35 min (max.) · Gear ratio: 5, 10, 36 				
				P.30	P.58	
TH Geared Type	—	<ul style="list-style-type: none"> · Gearhead assembled to motor · Low backlash gear with tapered gear · Permissible torque: 4 N·m (□60 mm) · Backlash: 45 min (max.) · Gear ratio: 3.6 ~ 30 				
				P.32	P.60	
SH Geared Type	—	<ul style="list-style-type: none"> · Gearhead assembled to motor · Effective to speed reducing, torque increasing, resolution increasing and vibration protection · Permissible Torque: 4 N·m (□60 mm) · Backlash: 1 ~ 2° (Reference value) · Gear ratio: 3.6 ~ 100 				
			P.10	P.34	P.62	P.70

Stepping Motor and Driver Packages

Stepping motor and driver package combines a stepping motor selected from various types, with a dedicated driver. You can use the product immediately so that the driver current is pre-adjusted to the each motor when shipping. A linear actuator equipped with stepping motor is also available.

● 2-Phase Stepping Motor and Driver Packages

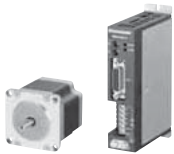

2-Phase Stepping Motor and Driver Package **RBK** Series → Page 80

- DC Input (20~75 VDC)
- Microstep
- Smooth Drive Function

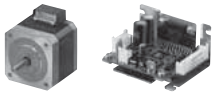

2-Phase Stepping Motor and Driver Package **CMK** Series → Page 82

- DC Input (24 VDC)
- Microstep

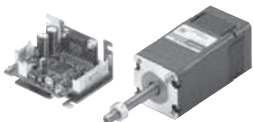

Compact Linear Actuator **DRB** Series → Page 84

- A stepping motor is integrated with a ball screw
- DC Input (24 VDC)
- Microstep
- A hollow rotor incorporating large bore thrust bearing

● 5-Phase Stepping Motor and Driver Packages

They offer higher resolution and capable of finer positioning operation.



5-Phase Stepping Motor and Driver Package **CRK** Series → Page 88

- DC Input (24 VDC)
- Microstep
- Smooth Drive Function
- Harmonic geared and other various geared motors are available



5-Phase Stepping Motor and Driver Package **RK** Series → Page 88

- AC Input (200-230 VAC)
- Microstep
- Smooth Drive Function
- Harmonic geared and other various geared motors are available
- Electromagnetic brake type is also available



Compact Linear Actuator **DRL** Series → Page 88

- A stepping motor is integrated with a ball screw
- DC Input (24 VDC)
- Microstep
- Repetitive Positioning Accuracy $\pm 0.005 \sim \pm 0.02$ mm
- Actuator with electromagnetic brake and with guide are available

High-Efficiency	□28 mm	High-Torque	□35 mm	Standard	□42 mm	Cable Type	IP54	Terminal Box	IP65	High-Resolution	□56.4 mm	PL Geared	□60 mm	TH Geared	□85 mm	SH Geared	□90 mm	Motor & Driver Packages	2-Phase	5-Phase	Accessories	Lead Wire/Connector	Coupling	Damper	Mounting Bracket
-----------------	--------	-------------	--------	----------	--------	------------	------	--------------	------	-----------------	----------	-----------	--------	-----------	--------	-----------	--------	-------------------------	---------	---------	-------------	---------------------	----------	--------	------------------

Features

High-Efficiency Type

Lower Heat Generation

Employing a high-efficiency technology, heat generation of the motor can be greatly reduced. (The temperature rise decreased by 50% of our conventional model.)

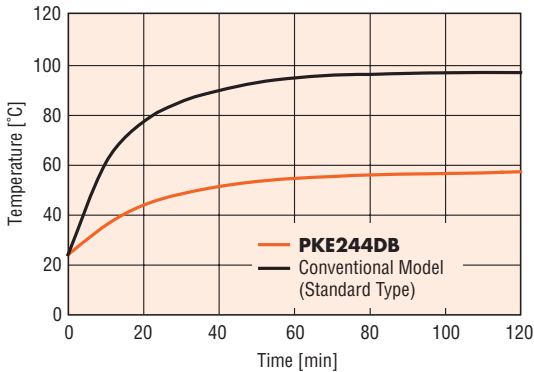

Lower Energy Consumption

By an energy-saving design, the consumption electricity decreases by 31% of our conventional model and CO₂ discharge reduces 10kg/year.

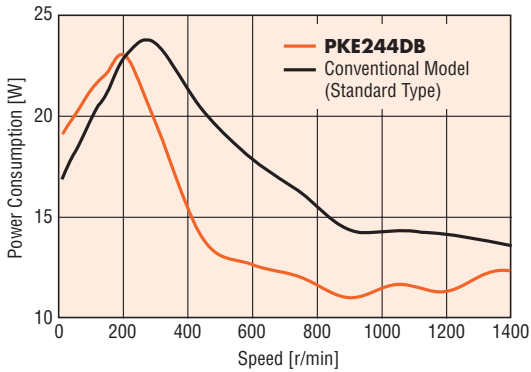

High-Torque Type

This motor type combines high torque and a compact size. Five frame sizes, 28 mm, 35 mm, 42 mm, 56.4 mm and 60 mm, are available. Each specification provides torque equivalent to a motor of the next larger frame size, supporting high-torque operation even in the high-speed range.

For example, high-torque type **PK246PB** motor frame size (42 mm) has the same holding torque as the standard type **PK266-01B** motor frame size (56.4 mm). This means a smaller size motor will maintain the same torque. This allows for downsized and lightweight equipment.

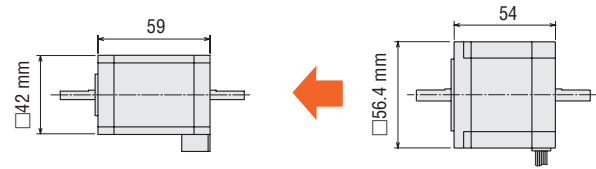
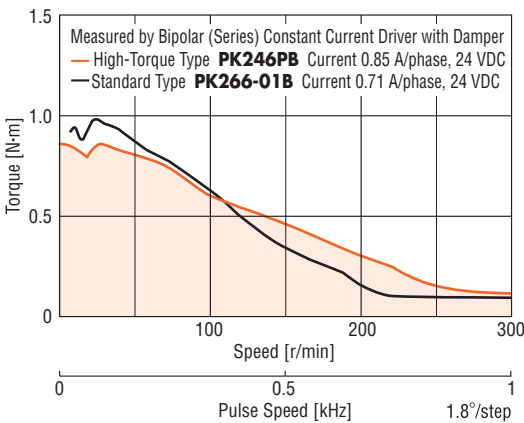

High-Torque Type PK246PB	Type Model	Standard Type PK266-01B
0.93 N·m	Holding Torque	1.17 N·m
$114 \times 10^{-7} \text{ kg}\cdot\text{m}^2$	Rotor Inertia	$300 \times 10^{-7} \text{ kg}\cdot\text{m}^2$

Easy-Handling Connection Using a Connector

With a connector type motor, we provide both type of product included with a motor lead wire/connector assembly of 0.6 m and the product which are not included (motor alone.)

When the motor lead wire/connector assembly is included with the product

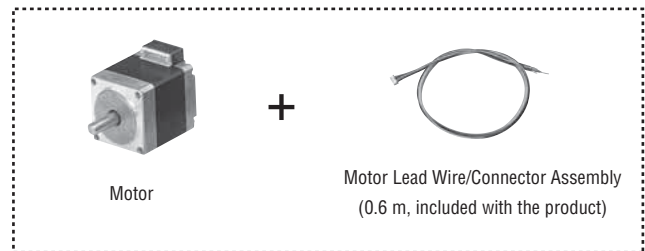

When the motor lead wire/connector assembly is not included with the product (Motor alone)

You must provide a lead wires/connector assembly or a motor connector set. They are available as an option.

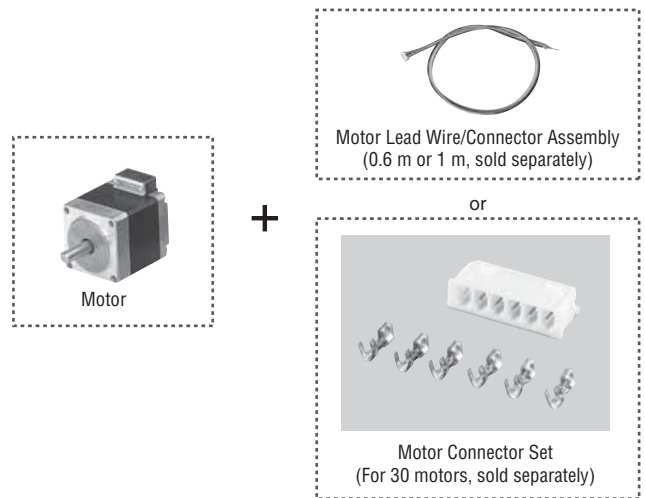

● **Standard Type**

The standard type offers balanced performance enhanced by high torque, low vibration and low noise. Optimal motor size and winding specification can be selected from a wide range of motor variations.

● **High-Resolution Type**

The high-resolution type has half the step angle of standard type. The high-resolution type increases motor resolution from 200 steps /rotation to 400 steps/rotation. Smaller step-angles, improving stopping accuracy and vibration can be achieved.

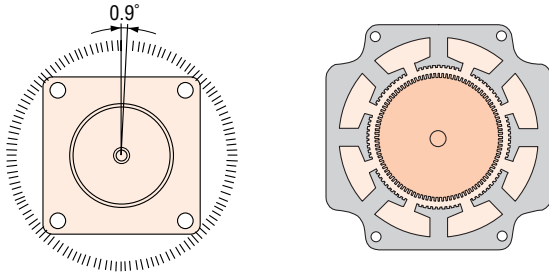

● **Standard Type IP54 Rated Motor with Cable**

The motor conforms to the IP54 standard to changing the lead wire outlet form lead wire to cable and cable clamp (excluding the mounting surface.) Motor with frame size □56.4mm is UL recognized and CSA certified.

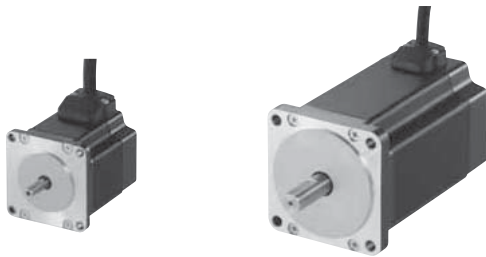

Product Line of Standard Type IP54 Rated Motor with Cable
Motor Frame Size: □56.4 mm, □85 mm

● **Standard Type IP65 Rated Motor with Terminal Box**

The motor conforms to the IP65 standard of ingress protection against dust and water. Sure connection is possible by adopting the terminal block to the joint section of the standard type motor.

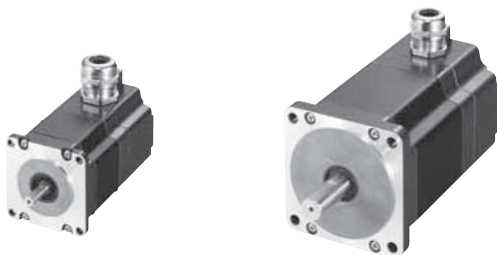

Product Line of Standard Type IP65 Rated Motor with Terminal Box

Motor Frame Size: □56.4 mm, □85 mm

● **Terminal-Block Connection Design**

The motor can be wired directly from its terminal block.

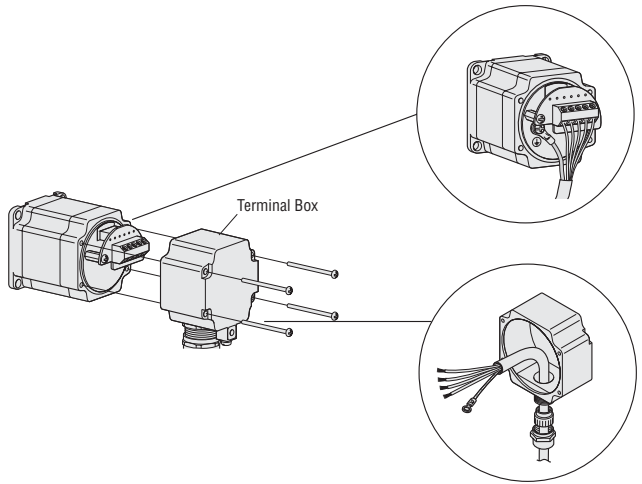

● **No Motor/Driver Relay**

Since the motor cable can be connected directly to the driver terminals, there is no need for wire connection or soldering on a relay terminal block.

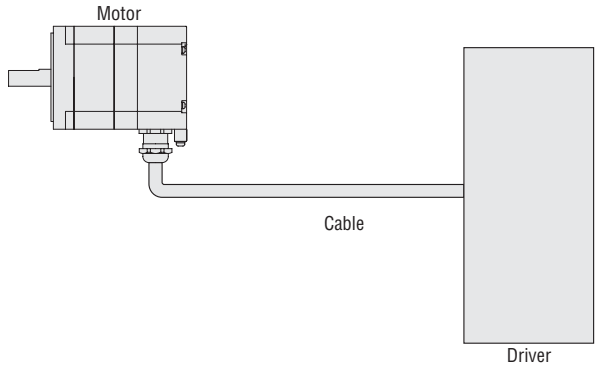

● **Standard Type with Encoder**

The motor equips a 3-channel output encoder. Precise position sensing is enabled by detecting the rotation amount, the rotation speed and the number of rotation. Two resolutions, 200 P/R and 400 P/R, are available.

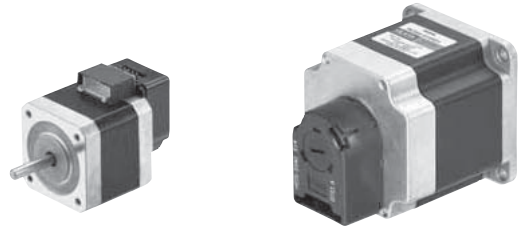

Product Line of Standard Type with Encoder

Motor Size	Type	Resolution
□42 mm	High-Torque	200P/R, 400P/R
□42 mm	Standard	200P/R, 400P/R
□42 mm	High-Resolution	400P/R
□56.4mm	Standard	200P/R, 400P/R
□56.4mm	High-Resolution	400P/R

High-Efficiency	□28 mm	High-Torque	□35 mm	Standard	□42 mm	IP54 Cable Type	□50 mm	IP65 Terminal Box	□56.4 mm	High-Resolution	□60 mm	PI Geared	□85 mm	SH Geared	□90 mm	Motor & Driver Package
																Accessories
																Coupling
																Damper
																Mounting Bracket

● **Geared Type**

These geared type stepping motor combine a stepping motor and a gear head which generates greater torque at low speed. The geared type ensures highly accurate, smooth operation even in applications where a large torque is received. These geared type incorporates a dedicated position-control gearhead with reduced backlash to make the most of the high controllability of the stepping motor.

◇ **PL Geared Type**

PL geared type employs a planetary gear speed-reduction mechanism. The planetary gear mechanism consists of three key parts: the sun gear, planetary gears and internal gear. The planetary gear also offers a high permissible torque and centered output shaft.

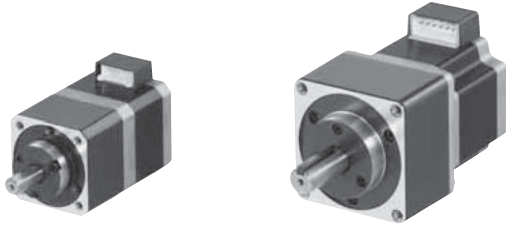

Product Line of PL Geared Type

Frame Size	Permissible Torque	Backlash	Gear Ratio
□42 mm	3 N·m (max.)	35 arc min	5, 10, 36
□60 mm	8 N·m (max.)	20 arc min	5, 10, 36

◇ **TH Geared Type**

In **TH** geared type, tapered gears are used for the spur gear's speed-reduction mechanism and the meshing gear. Low speed gear ratios, from 3.6 to 30, are available.

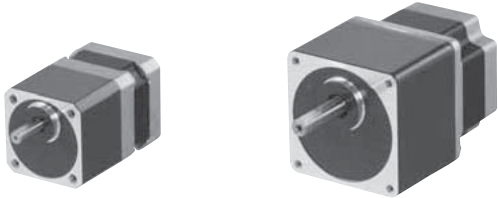

Product Line of TH Geared Type

Frame Size	Permissible Torque	Backlash	Gear Ratio
□42 mm	1.5 N·m (max.)	45 arc min (max.)	3.6 ~ 30
□60 mm	4 N·m (max.)	35 arc min (max.)	3.6 ~ 30

◇ **SH Geared Type**

SH geared type employs popular gear head with spur gear's speed reduction mechanism. It offers full benefit of the speed reduction, high torque and smooth low-speed rotation.

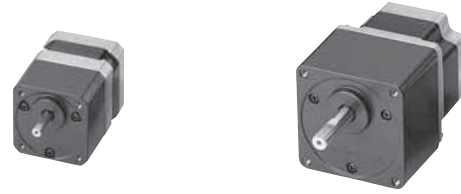

Product Line of SH Geared Type

Frame Size	Permissible Torque	Backlash (Reference Value)	Gear Ratio
□28 mm	0.4 N·m (max.)	1 - 2°	7.2 ~ 36
□42 mm	0.8 N·m (max.)	1 - 2°	3.6 ~ 100
□60 mm	4 N·m (max.)	1 - 2°	3.6 ~ 36
□90 mm	12 N·m (max.)	1 - 2°	3.6 ~ 36

Product Number Code

High-Efficiency Type

PKE 2 4 4 D A - L

① ② ③ ④ ⑤ ⑥ ⑦

①	Series & Type	PK: PK Series High-Efficiency Type
②	2: 2-Phase	
③	Motor Frame Size	4: 42 mm
④	Motor Case Length	
⑤	Motor Lead (Pin)	Blank: 6 Leads (6 Pins) D: 4 Leads (4 Pins)
⑥	Shaft Type	A: Single Shaft B: Double Shaft
⑦	Motor Lead Wire/ Connector Assembly	L: Included (0.6 m)

Standard Type

High-Resolution Type

PK 2 6 6 M - E 2.0 B

① ② ③ ④ ⑤ ⑥ ⑦ ⑧

①	Series	PK: PK Series
②	2: 2-Phase	
③	Motor Frame Size	4: 42 mm 5: 50 mm 6: 56.4 mm 9: 85 mm
④	Motor Case Length	
⑤	Motor Type	Blank: Standard Type (1.8°/step) M: High-Resolution Type (0.9°/step)
⑥	Motor Lead	O: 6 Leads E: 8 Leads
⑦	Winding Specification	
⑧	Shaft Type	A: Single Shaft B: Double Shaft

High-Torque Type with Encoder

Standard Type with Encoder

High-Resolution Type with Encoder

PK 2 4 6 P A R 21 - L

① ② ③ ④ ⑤ ⑧ ⑨ ⑩ ⑪

PK 2 6 6 M - 0 1 A R 22 - L

① ② ③ ④ ⑤ ⑥ ⑦ ⑧ ⑨ ⑩ ⑪

①	Series	PK: PK Series
②	2: 2-Phase	
③	Motor Frame Size	4: 42 mm 6: 56.4 mm
④	Motor Case Length	
⑤	Motor Type	Blank: Standard Type (1.8°/step) P: High-Torque Type (1.8°/step) M: High-Resolution Type (0.9°/step)
⑥	Motor Lead	O: 6 Leads E: 8 Leads
⑦	Winding Specification	
⑧	Shaft Type	A: Single Shaft
⑨	Encoder	R: Encoder Equipped
⑩	Encoder Resolution	21: 200P/R 22: 400P/R
⑪	Encoder Lead Wire/ Connector Assembly*	Blank: Not included L: Included (0.6 m)

*For high-torque type of motor frame size 42 mm, a motor lead wire/connector assembly (0.6 m) is also included.

High-Torque Type

PK 2 4 4 P A - L

① ② ③ ④ ⑤ ⑦ ⑧

①	Series	PK: PK Series
②	2: 2-Phase	
③	Motor Frame Size	2: 28 mm 3: 35 mm 4: 42 mm 6: 56.4 mm/60 mm
④	Motor Case Length	
⑤	Motor Type	P/J: High-Torque Type
⑥	Motor Lead	Blank: 6 Leads (6 Pins) D: 4 Leads (4 Pins)
⑦	Shaft Type	A: Single Shaft B: Double Shaft
⑧	Motor Lead Wire/ Connector Assembly	Blank: Not included L: Included (0.6 m)

Standard Type IP54 Rated Motor with Cable

Standard Type IP65 Rated Motor with Terminal Box

PK 2 6 6 D A T

① ② ③ ④ ⑤ ⑥ ⑦

①	Series	PK: PK Series
②	2: 2-Phase	
③	Motor Frame Size	6: 56.4 mm 9: 85 mm
④	Motor Case Length	
⑤	Motor Terminal or Motor Lead	D, D1: 4 Terminals (4 Leads) E: 8 Terminals
⑥	Shaft Type	A: Blank: Single Shaft
⑦	Connection Method	T: Terminal Box W: Cable

Geared Type

PK 2 6 4 A E - SG 10

① ② ③ ④ ⑦ ⑥ ⑧ ⑨

PK 2 6 6 P D B - P 10 - L

① ② ③ ④ ⑤ ⑥ ⑦ ⑧ ⑨ ⑩

①	Series	PK: PK Series
②	2: 2-Phase	
③	Motor Frame Size	4: 42 mm 6: 60 mm 9: 90 mm
④	Motor Case Length	
⑤	Motor Type	
⑥	Motor Lead or Motor Terminal	1: 6 Leads D: 4 Leads (4 Terminals) E: 8 Leads (8 Terminals)
⑦	Shaft Type	A: Single Shaft B: Double Shaft
⑧	Gearhead Type	SG: SH Geared Type T: TH Geared Type P: PL Geared type
⑨	Gear Ratio	
⑩	Motor Lead Wire/ Connector Assembly	Blank: Not included L: Included (0.6 m)

High-Efficiency	28 mm
High-Torque	35 mm
Standard	42 mm
Cable Type	IP54
Terminal Box	IP65
High-Resolution	56.4 mm
PL Geared	60 mm
TH Geared	85 mm
SH Geared	90 mm
2-Phase	Motor & Driver Package
5-Phase	
Lead Wire/ Connector	Accessories
Coupling	
Damper	
Mounting Bracket	

28 mm

Step Angle 1.8°
High-Torque Type

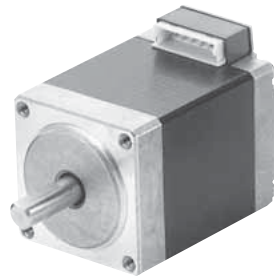

Specifications (RoHS)

Model Single Shaft Double Shaft	Connection Type	Holding Torque N·m	Current per Phase A/phase	Voltage V	Resistance per Phase Ω/phase	Inductance mH/phase	Rotor Inertia J: kg·m ²	Lead Wires (Pin)	Wirings and Connections (See page 76)	Corresponding Motor & Driver Packages	
										Model	Page
PK223PDA-L* PK223PDA PK223PDB-L* PK223PDB	Bipolar	0.065	1.5	1.8	1.2	0.74	9×10 ⁻⁷	4	①	RBK223PA RBK223PB	P.80
PK223PA-L* PK223PA	Bipolar (Series)	0.065	0.67	3.8	5.6	4	9×10 ⁻⁷	6	③	-	-
PK223PB-L* PK223PB	Unipolar	0.05	0.95	2.66	2.8	1			②	CMK223PAP CMK223PBP	P.82
PK224PDA-L* PK224PDA PK224PDB-L* PK224PDB	Bipolar	0.097	1.5	2.32	1.55	0.85	12×10 ⁻⁷	4	①	RBK224PA RBK224PB	P.80
PK224PA-L* PK224PA	Bipolar (Series)	0.097	0.67	4.6	6.8	4.8	12×10 ⁻⁷	6	③	-	-
PK224PB-L* PK224PB	Unipolar	0.075	0.95	3.2	3.4	1.2			②	CMK224PAP CMK224PBP	P.82
PK225PDA-L* PK225PDA PK225PDB-L* PK225PDB	Bipolar	0.11	1.5	3	2.05	1	18×10 ⁻⁷	4	①	RBK225PA RBK225PB	P.80
PK225PA-L* PK225PA	Bipolar (Series)	0.11	0.67	6.2	9.2	5.6	18×10 ⁻⁷	6	③	-	-
PK225PB-L* PK225PB	Unipolar	0.09	0.95	4.4	4.6	1.4			②	CMK225PAP CMK225PBP	P.82

How to read specifications table → Page 78

● Degree of Protection: IP30

* Motor lead wire/connector assembly of 0.6 m is included with the product which have "-L" at the end of the model name.

Motor lead wire/connector assembly is not included with the product that has no "-L" at the end of the model name.

Dimensions (Unit = mm)

Model	Motor Model	L1	L2	Mass kg
PK223PDA-L, PK223PDA	PK223PDA	32	-	0.11
PK223PA-L, PK223PA	PK223PA		-	
PK223PDB-L, PK223PDB	PK223PDB		42	
PK223PB-L, PK223PB	PK223PB	40	-	0.14
PK224PDA-L, PK224PDA	PK224PDA		-	
PK224PA-L, PK224PA	PK224PA		50	
PK224PDB-L, PK224PDB	PK224PDB	51.5	-	0.2
PK224PB-L, PK224PB	PK224PB		-	
PK225PDA-L, PK225PDA	PK225PDA		61.5	
PK225PA-L, PK225PA	PK225PA	51.5	-	0.2
PK225PDB-L, PK225PDB	PK225PDB		-	
PK225PB-L, PK225PB	PK225PB	61.5	-	

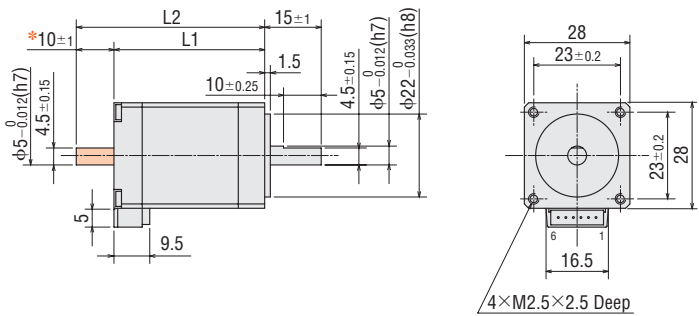

* The length of machining on double shaft model is 10±0.25.

● These dimensions are for double shaft models. For single shaft models, ignore the orange (■) areas.

● Applicable Connector

Connector Housing: 51065-0600 (MOLEX)

Contact: 50212-8100 (MOLEX)

Crimp Tool: 57176-5000 (MOLEX)

● Motor Lead Wire/Connector Assembly (Included with the product which have "-L" at the end of the model name)

LC2B06A (Included with **PK22□P□-L**)

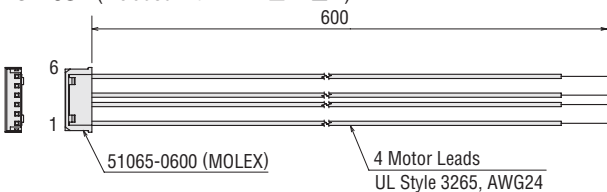

LC2U06A (Included with **PK22□P□-L**)

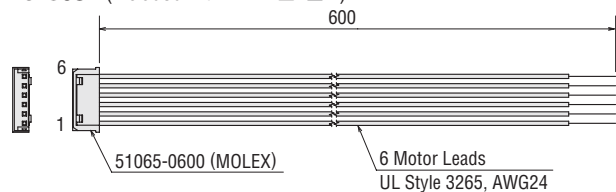

● Enter the motor case length in the box (□) within the model name.

Enter **A** (single shaft) or **B** (double shaft) in the box (■) within the model name.

PK223PDA-L/PK223PDB-L

Bipolar

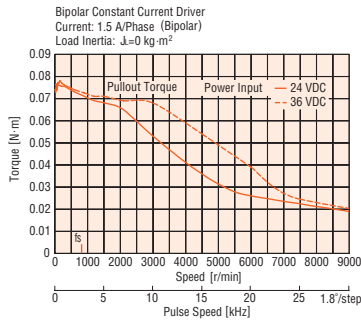

PK224PDA-L/PK224PDB-L

Bipolar

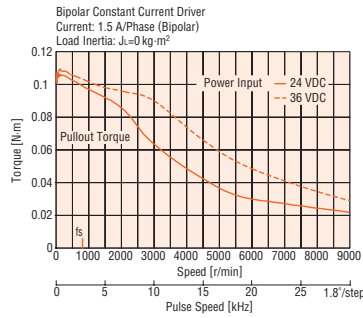

PK225PDA-L/PK225PDB-L

Bipolar

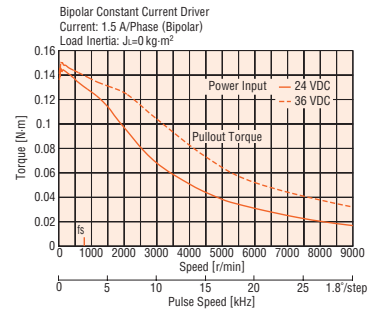

PK223PA-L/PK223PB-L

Bipolar (Series)

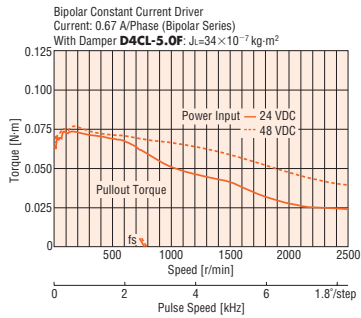

PK224PA-L/PK224PB-L

Bipolar (Series)

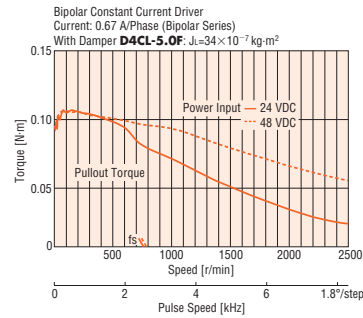

PK225PA-L/PK225PB-L

Bipolar (Series)

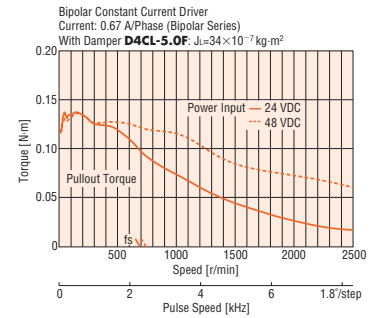

PK223PA-L/PK223PB-L

Unipolar

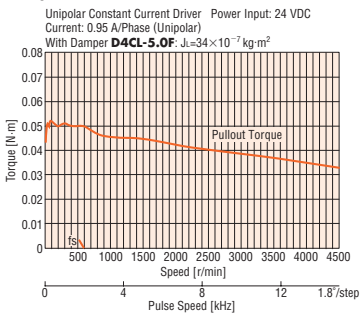

PK224PA-L/PK224PB-L

Unipolar

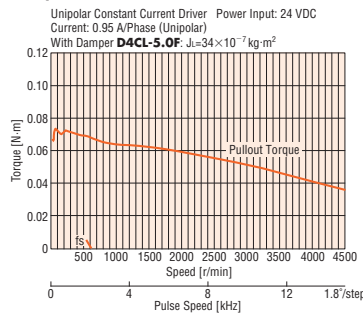

PK225PA-L/PK225PB-L

Unipolar

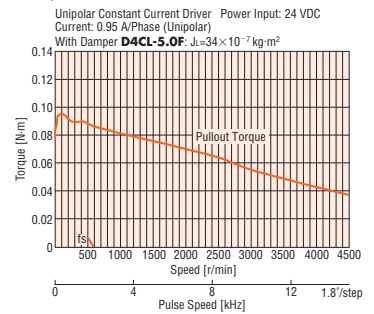

Note:

● Pay attention to heat dissipation from motor as there will be a considerable amount of heat under certain conditions. Be sure to keep the temperature of the motor case under 100°C.

Accessories (Sold separately)

If you select a product without motor lead wire/connector assembly (motor alone), applicable connector and lead wires must be furnished separately. They are available as an option.

- Motor Lead Wire/Connector Assembly → Page 90
- Motor Connector Set → Page 90

High-Efficiency	28 mm
High-Torque	35 mm
Standard	42 mm
Cable Type	IP54
Terminal Box	IP65
High-Resolution	56.4 mm
PL Geared	60 mm
TH Geared	85 mm
SH Geared	90 mm
2-Phase	Motor & Driver Package
5-Phase	
Lead Wire/Connector	
Coupling	Accessories
Damper	
Mounting Bracket	

28 mm SH Geared Type



Specifications (RoHS)

Motor Specifications

Model Single Shaft Double Shaft	Connection Type	Current per Phase A/phase	Voltage V	Resistance per Phase Ω /phase	Inductance mH/phase	Rotor Inertia J: kg·m ²	Lead Wires (Pin)	Wiring and Connections (See Page 76)	Corresponding Motor & Driver Package	
									Model	Page
PK223PA-SG <input type="checkbox"/> -L* PK223PA-SG <input type="checkbox"/>	Bipolar (Series)	0.67	3.8	5.6	4	9×10^{-7}	6	③	-	-
PK223PB-SG <input type="checkbox"/> -L* PK223PB-SG <input type="checkbox"/>	Unipolar	0.95	2.66	2.8	1				CMK223AP-SG <input type="checkbox"/> CMK223BP-SG <input type="checkbox"/>	P.82

How to read specifications table → Page 78

- Degree of Protection: IP30
- Enter the gear ratio in the box (□) within the model name.
- Backlash value is approximately 1 to 2°.
- * Motor lead wire/connector assembly of 0.6 m is included with the product which have "-L" at the end of the model name.
Motor lead wire/connector assembly is not included with the product that has no "-L" at the end of the model name.

Note:

- Direction of rotation of the motor and that of the gear output shaft are the same for the gear ratios 1:7.2 and 1:36. It is the opposite for 1:9, 1:10 and 1:18 gear ratios.

Gearmotor Specifications

Model Single Shaft Double Shaft	Gear Ratio	Holding Torque N·m	Step Angle	Permissible Speed r/min
PK223PA-SG7.2-L , PK223PA-SG7.2 PK223PB-SG7.2-L , PK223PB-SG7.2	1:7.2	0.3	0.25°	250
PK223PA-SG9-L , PK223PA-SG9 PK223PB-SG9-L , PK223PB-SG9	1:9	0.3	0.2°	200
PK223PA-SG10-L , PK223PA-SG10 PK223PB-SG10-L , PK223PB-SG10	1:10	0.3	0.18°	180
PK223PA-SG18-L , PK223PA-SG18 PK223PB-SG18-L , PK223PB-SG18	1:18	0.4	0.1°	100
PK223PA-SG36-L , PK223PA-SG36 PK223PB-SG36-L , PK223PB-SG36	1:36	0.4	0.05°	50

- Holding torque is the same regardless of the connection type, due to the permissible torque limit of the gearhead.

Dimensions (Unit = mm)

Model	Motor Model	Mass kg
PK223PA-SG <input type="checkbox"/> -L PK223PA-SG <input type="checkbox"/>	PK223PA-SG <input type="checkbox"/>	0.16
PK223PB-SG <input type="checkbox"/> -L PK223PB-SG <input type="checkbox"/>	PK223PB-SG <input type="checkbox"/>	

- Enter the gear ratio in the box (□) within the model name.

Applicable Connector

Connector Housing: 51065-0600 (MOLEX)
Contact: 50212-8100 (MOLEX)
Crimp Tool: 57176-5000 (MOLEX)

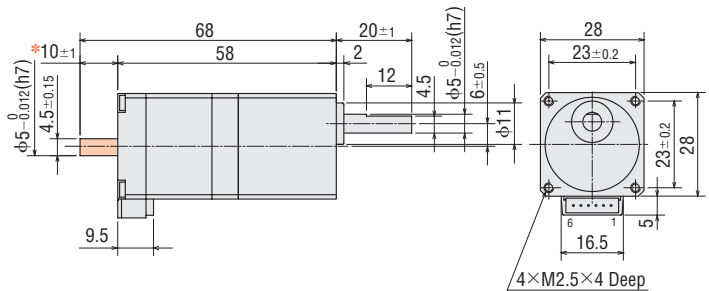

* The length of machining on double shaft model is 10 ± 0.25 .

- These dimensions are for double shaft models. For single shaft models, ignore the orange (■) areas.

- Screws (Included): M2.5 Length 8mm × 4 pieces

- Motor Lead Wire/Connector Assembly (Included with the product which have "-L" at the end of the model name): **LC2U06A**

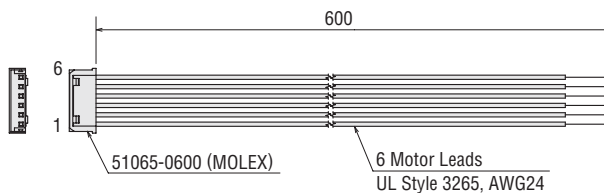

Speed – Torque Characteristics

How to read speed – torque characteristics → Page 79

PK223PA-SG□-L/PK223PB-SG□-L

Bipolar (Series) 24 VDC

Bipolar Constant Current Driver Power Input: 24 VDC
Current: 0.67 A/Phase (Bipolar Series)
With Damper **D4CL-5.0F**: $J_L=34 \times 10^{-7} \text{ kg}\cdot\text{m}^2$

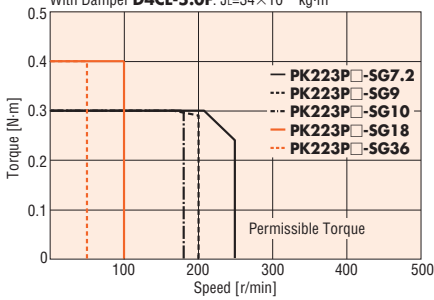

PK223PA-SG□-L/PK223PB-SG□-L

Unipolar 24 VDC

Unipolar Constant Current Driver Power Input: 24 VDC
Current: 0.95 A/Phase (Unipolar)
With Damper **D4CL-5.0F**: $J_L=34 \times 10^{-7} \text{ kg}\cdot\text{m}^2$

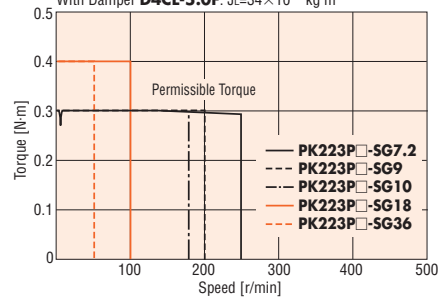

PK223PA-SG□-L/PK223PB-SG□-L

Bipolar (Series) 48 VDC

Bipolar Constant Current Driver Power Input: 48 VDC
Current: 0.67 A/Phase (Bipolar Series)
With Damper **D4CL-5.0F**: $J_L=34 \times 10^{-7} \text{ kg}\cdot\text{m}^2$

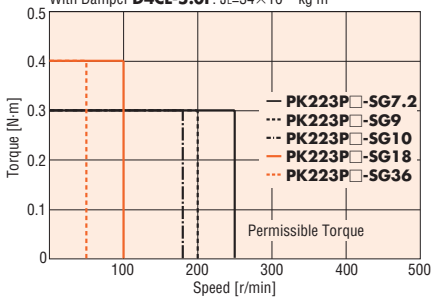

Note:

● Pay attention to heat dissipation from motor as there will be a considerable amount of heat under certain conditions. Be sure to keep the temperature of the motor case under 100°C.

Accessories (Sold separately)

If you select a product without motor lead wire/connector assembly (motor alone), applicable connector and lead wires must be furnished separately. They are available as an option.

- Motor Lead Wire/Connector Assembly → Page 90
- Motor Connector Set → Page 90

High-Efficiency	28 mm
High-Torque	35 mm
Standard	42 mm
Cable Type	IP54
Terminal Box	IP55
High-Resolution	60 mm
PL Geared	85 mm
TH Geared	90 mm
SH Geared	90 mm
2-Phase	Motor & Driver Package
5-Phase	Motor & Driver Package
Lead Wire/Connector	Accessories
Coupling	
Damper	
Mounting Bracket	

35 mm

Step Angle 1.8°
High-Torque Type



Specifications RoHS

Model Single Shaft Double Shaft	Connection Type	Holding Torque N·m	Current per Phase A/phase	Voltage V	Resistance per Phase Ω/phase	Inductance mH/phase	Rotor Inertia J: kg·m ²	Lead Wires (Pin)	Wiring and Connections (See Page 76)	Corresponding Motor & Driver Package	
										Model	Page
PK233PDA-L* PK233PDA PK233PDB-L* PK233PDB	Bipolar	0.2	1.5	2.43	1.62	1.5	24×10 ⁻⁷	4	①	RBK233PA RBK233PB	P.80
PK233PA-L* PK233PA PK233PB-L* PK233PB	Bipolar (Series)	0.2	0.85	4.6	5.4	5.6	24×10 ⁻⁷	6	③	—	—
	Unipolar	0.16	1.2	3.24	2.7	1.4			②	CMK233PAP CMK233PBP	P.82
PK235PDA-L* PK235PDA PK235PDB-L* PK235PDB	Bipolar	0.37	1.5	3.6	2.4	2.6	50×10 ⁻⁷	4	①	RBK235PA RBK235PB	P.80
PK235PA-L* PK235PA PK235PB-L* PK235PB	Bipolar (Series)	0.37	0.85	5.8	6.8	8	50×10 ⁻⁷	6	③	—	—
	Unipolar	0.3	1.2	4.08	3.4	2			②	CMK235PAP CMK235PBP	P.82

How to read specifications table → Page 78

● Degree of Protection: IP30

* Motor lead wire/connector assembly of 0.6 m is included with the product which have “-L” at the end of the model name.

Motor lead wire/connector assembly is not included with the product that has no “-L” at the end of the model name.

Dimensions (Unit = mm)

Model	Motor Model	L1	L2	Mass kg
PK233PDA-L, PK233PDA	PK233PDA	37	—	0.18
PK233PA-L, PK233PA	PK233PA			
PK233PDB-L, PK233PDB	PK233PDB			
PK233PB-L, PK233PB	PK233PB	52	—	0.285
PK235PDA-L, PK235PDA	PK235PDA	52	—	
PK235PA-L, PK235PA	PK235PA			
PK235PDB-L, PK235PDB	PK235PDB			
PK235PB-L, PK235PB	PK235PB	67	—	

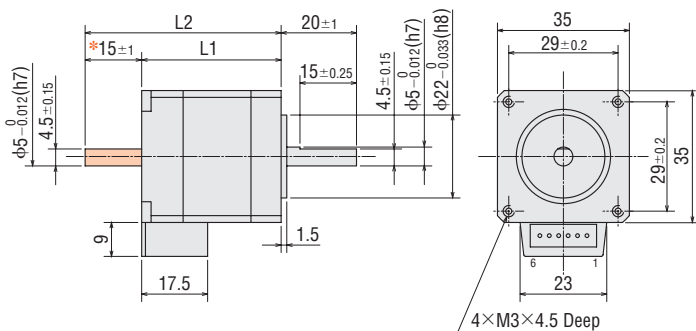

* The length of machining on double shaft model is 15±0.25.

● These dimensions are for double shaft models. For single shaft models, ignore the orange (■) areas.

● Applicable Connector

Connector Housing: 51103-0600 (MOLEX)

Contact: 50351-8100 (MOLEX)

Crimp Tool: 57295-5000 (MOLEX)

● Motor Lead Wire/Connector Assembly (Included with the product which have “-L” at the end of the model name)

LC2B06B (Included with **PK23□PD■-L**)

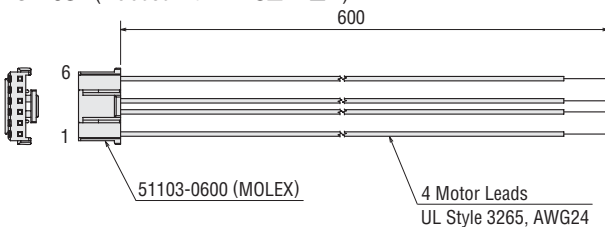

LC2U06B (Included with **PK23□P■-L**)

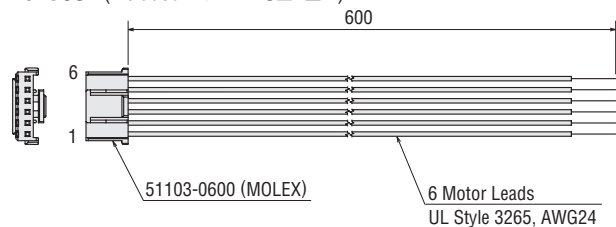

● Enter the motor case length in the box (□) within the model name.

Enter **A** (single shaft) or **B** (double shaft) in the box (■) within the model name.

Speed – Torque Characteristics

How to read speed – torque characteristics → Page 79

PK233PDA-L/PK233PDB-L

Bipolar

Bipolar Constant Current Driver
Current: 1.5 A/Phase (Bipolar)
Load Inertia: $J_L=0 \text{ kg}\cdot\text{m}^2$

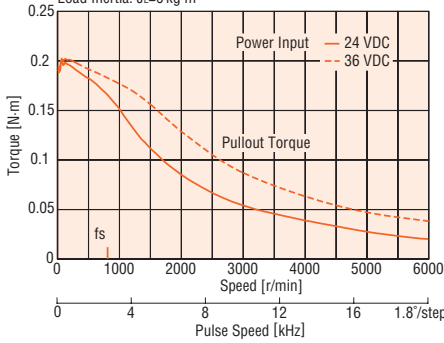

PK235PDA-L/PK235PDB-L

Bipolar

Bipolar Constant Current Driver
Current: 1.5 A/Phase (Bipolar)
Load Inertia: $J_L=0 \text{ kg}\cdot\text{m}^2$

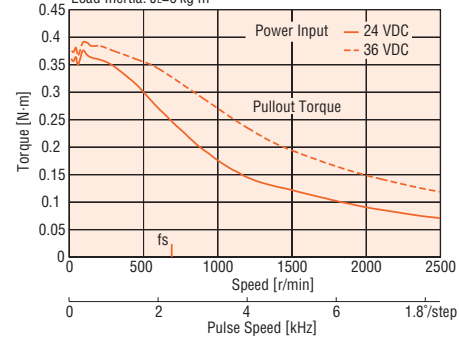

PK233PA-L/PK233PB-L

Bipolar (Series)

Bipolar Constant Current Driver
Current: 0.85 A/Phase (Bipolar Series)
With Damper **D4CL-5.0F**: $J_L=34 \times 10^{-7} \text{ kg}\cdot\text{m}^2$

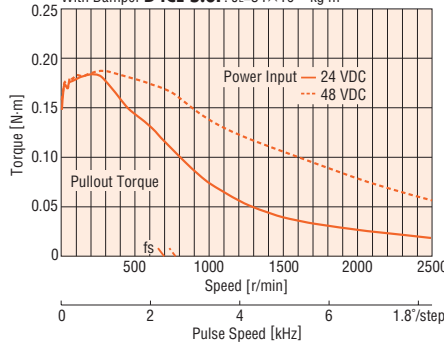

PK235PA-L/PK235PB-L

Bipolar (Series)

Bipolar Constant Current Driver
Current: 0.85 A/Phase (Bipolar Series)
With Damper **D4CL-5.0F**: $J_L=34 \times 10^{-7} \text{ kg}\cdot\text{m}^2$

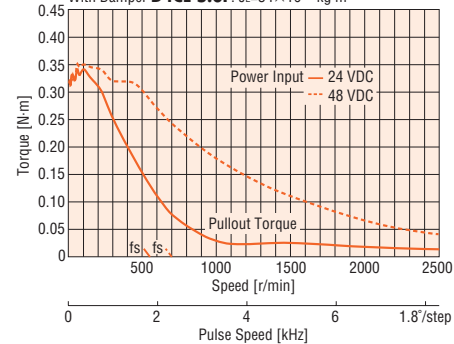

PK233PA-L/PK233PB-L

Unipolar

Unipolar Constant Current Driver Power Input: 24 VDC
Current: 1.2 A/Phase (Unipolar)
With Damper **D4CL-5.0F**: $J_L=34 \times 10^{-7} \text{ kg}\cdot\text{m}^2$

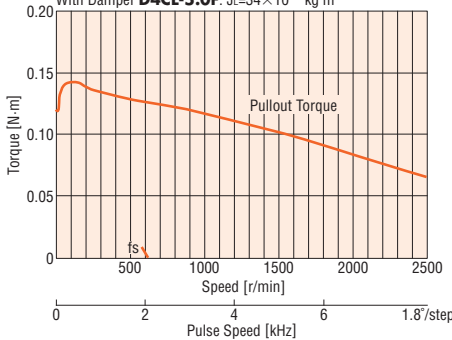

PK235PA-L/PK235PB-L

Unipolar

Unipolar Constant Current Driver Power Input: 24 VDC
Current: 1.2 A/Phase (Unipolar)
With Damper **D4CL-5.0F**: $J_L=34 \times 10^{-7} \text{ kg}\cdot\text{m}^2$

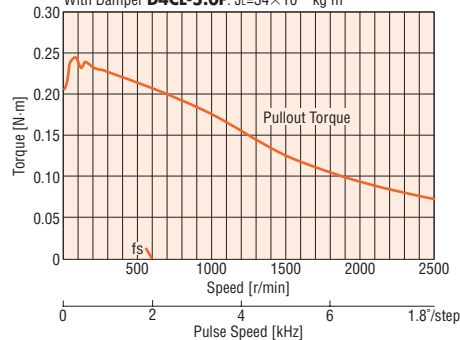

Note:

● Pay attention to heat dissipation from motor as there will be a considerable amount of heat under certain conditions. Be sure to keep the temperature of the motor case under 100°C.

Accessories (Sold separately)

If you select a product without motor lead wire/connector assembly (motor alone), applicable connector and lead wires must be furnished separately. They are available as an option.

- Motor Lead Wire/Connector Assembly → Page 90
- Motor Connector Set → Page 90

High-Efficiency	28 mm
High-Torque	35 mm
Standard	42 mm
Cable Type	IP54
Terminal Box	IP65
Resolution	High
PL Geared	60 mm
TH Geared	85 mm
SH Geared	90 mm
2-Phase	Motor & Driver Package
5-Phase	
Lead Wire/Connector	Accessories
Coupling	
Damper	
Mounting Bracket	

42 mm
 Step Angle 1.8°
 High-Efficiency Type

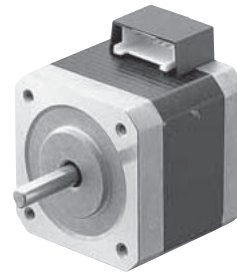

Specifications (RoHS)

Model Single Shaft Double Shaft	Connection Type	Holding Torque N·m	Current per Phase A/phase	Voltage V	Resistance per Phase Ω/phase	Inductance mH/phase	Rotor Inertia J: kg·m ²	Lead Wires (Pin)	Wirings and Connections (See Page 76)
PKE244DA-L PKE244DB-L	Bipolar	0.48	1.5	3.9	2.6	4.9	57×10 ⁻⁷	4	①
PKE244A-L PKE244B-L	Bipolar (Series) Unipolar	0.48 0.39	0.85 1.2	6.8 4.8	8 4	15.6 3.9	57×10 ⁻⁷	6	③ ②

How to read specifications table → Page 78

- Degree of Protection: IP30
- For the information of the applicable driver, please contact the nearest Oriental Motor sales office.

Dimensions (Unit = mm)

Model	Motor Model	L1	L2	Mass kg
PKE244DA-L	PKE244DA	39	—	0.3
PKE244A-L	PKE244A			
PKE244DB-L	PKE244DB			
PKE244B-L	PKE244B		54	

- Applicable Connector
 Connector Housing: 51103-0600 (MOLEX)
 Contact: 50351-8100 (MOLEX)
 Crimp Tool: 57295-5000 (MOLEX)

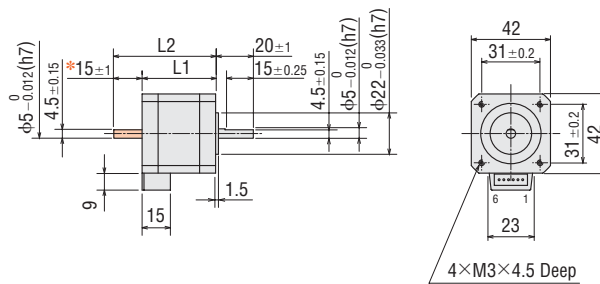

- * The length of machining on double shaft model is 15±0.25.
- These dimensions are for double shaft models. For single shaft models, ignore the orange (■) areas.

- Motor Lead Wire/Connector Assembly (Included)

LC2B06B (Included with **PKE244□-L**)

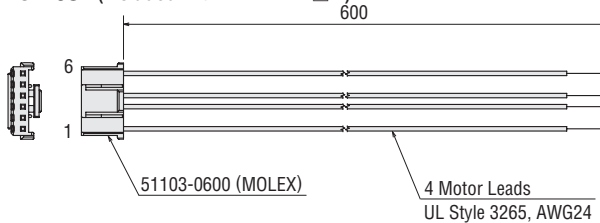

LC2U06B (Included with **PKE244□-L**)

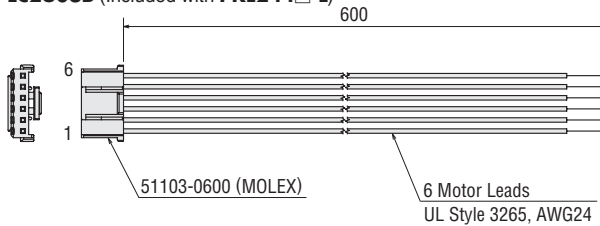

- Enter **A** (single shaft) or **B** (double shaft) in the box (□) within the model name.

Speed – Torque Characteristics

How to read speed – torque characteristics → Page 79

PKE244DA-L/PKE244DB-L

Bipolar

Bipolar Constant Current Driver
Current: 1.5 A/Phase (Bipolar)
Load Inertia: $J_L=0 \text{ kg}\cdot\text{m}^2$

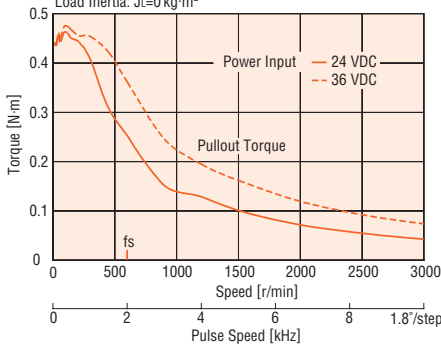

PKE244A-L/PKE244B-L

Bipolar (Series)

Bipolar Constant Current Driver
Current: 0.85 A/Phase (Bipolar Series)
With Damper **D4CL-5.0F**: $J_L=34 \times 10^{-7} \text{ kg}\cdot\text{m}^2$

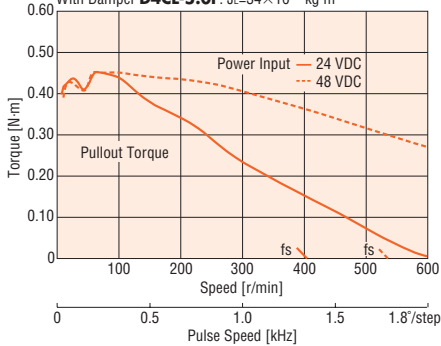

PKE244A-L/PKE244B-L

Unipolar

Unipolar Constant Current Driver Power Input: 24 VDC
Current: 1.2 A/Phase (Unipolar)
With Damper **D4CL-5.0F**: $J_L=34 \times 10^{-7} \text{ kg}\cdot\text{m}^2$

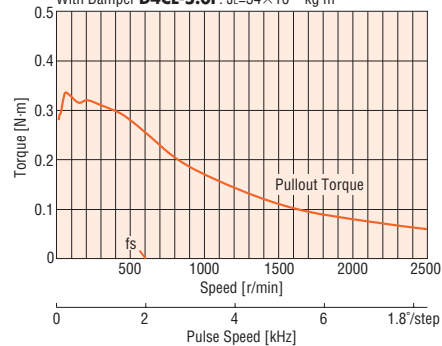

Note:

- Pay attention to heat dissipation from motor as there will be a considerable amount of heat under certain conditions. Be sure to keep the temperature of the motor case under 100°C.

Accessories (Sold separately)

Motor lead wire/connector assembly is included with the product. Motor lead wire/connector assembly and motor connector are also available as an option to facilitate repairs. Select them according to necessity.

- Motor Lead Wire/Connector Assembly → Page 90
- Motor Connector Set → Page 90

High-Efficiency	28 mm
High-Torque	35 mm
Standard	42 mm
IP54 Cable Type	50 mm
Terminal Box	IP55
High-Resolution	56.4 mm
PL Geared	60 mm
TH Geared	85 mm
SH Geared	90 mm
2-Phase	Motor & Driver Package
5-Phase	
Lead Wire/Connector	Accessories
Coupling	
Damper	
Mounting Bracket	

42 mm

Step Angle 1.8°
High-Torque Type

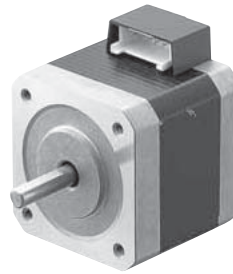

Specifications (RoHS)

Model Single Shaft Double Shaft	Connection Type	Holding Torque N-m	Current per Phase A/phase	Voltage V	Resistance per Phase Ω/phase	Inductance mH/phase	Rotor Inertia J: kg-m ²	Lead Wires (Pin)	Wirings and Connections (See Page 76)	Corresponding Motor & Driver Package	
										Model	Page
PK244PDA-L* PK244PDA PK244PDB-L* PK244PDB	Bipolar	0.48	1.5	3.9	2.6	4.9	57×10 ⁻⁷	4	①	RBK244PA RBK244PB	P.80
PK244PA-L* PK244PA PK244PB-L* PK244PB	Bipolar (Series)	0.48	0.85	6.8	8	15.6	57×10 ⁻⁷	6	③	-	-
	Unipolar	0.39	1.2	4.8	4	3.9			②	CMK244PAP CMK244PBP	P.82
PK246PDA-L* PK246PDA PK246PDB-L* PK246PDB	Bipolar	0.93	1.5	5.8	3.87	8	114×10 ⁻⁷	4	①	RBK246PA RBK246PB	P.80
PK246PA-L* PK246PA PK246PB-L* PK246PB	Bipolar (Series)	0.93	0.85	10	12	26	114×10 ⁻⁷	6	③	-	-
	Unipolar	0.75	1.2	7.2	6	6.5			②	CMK246PAP CMK246PBP	P.82

How to read specifications table → Page 78

● Degree of Protection: IP30

* Motor lead wire/connector assembly of 0.6 m is included with the product which have “-L” at the end of the model name.

Motor lead wire/connector assembly is not included with the product that has no “-L” at the end of the model name.

Dimensions (Unit = mm)

Model	Motor Model	L1	L2	Mass kg
PK244PDA-L, PK244PDA	PK244PDA	39	-	0.3
PK244PA-L, PK244PA	PK244PA		-	
PK244PDB-L, PK244PDB	PK244PDB		54	
PK244PB-L, PK244PB	PK244PB		-	
PK246PDA-L, PK246PDA	PK246PDA	59	-	0.5
PK246PA-L, PK246PA	PK246PA		-	
PK246PDB-L, PK246PDB	PK246PDB		74	
PK246PB-L, PK246PB	PK246PB		-	

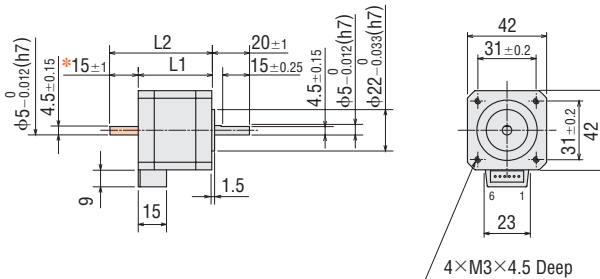

* The length of machining on double shaft model is 15±0.25.

● These dimensions are for double shaft models. For single shaft models, ignore the orange (■) areas.

● Applicable Connector

Connector Housing: 51103-0600 (MOLEX)

Contact: 50351-8100 (MOLEX)

Crimp Tool: 57295-5000 (MOLEX)

● Motor Lead Wire/Connector Assembly (Included with the product which have “-L” at the end of the model name)

LC2B06B (Included with **PK24□PDB-L**)

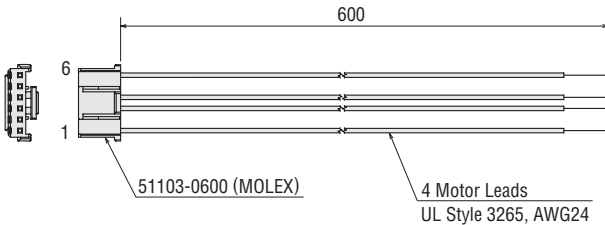

LC2U06B (Included with **PK24□PA-L**)

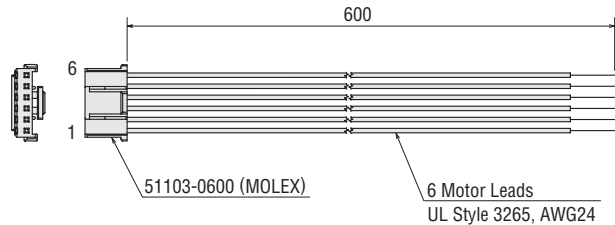

● Enter the motor case length in the box (□) within the model name.

Enter **A** (single shaft) or **B** (double shaft) in the box (■) within the model name.

42 mm

Step Angle 1.8°
High-Torque Type with Encoder

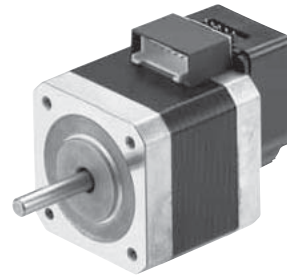

Specifications (RoHS)

Model Single Shaft	Connection Type	Holding Torque N-m	Current per Phase A/phase	Voltage V	Resistance per Phase Ω/phase	Inductance mH/phase	Rotor Inertia J: kg·m ²	Lead Wires (Pin)	Wirings and Connections (See Page 76)
PK244PAR21-L	Bipolar (Series)	0.48	0.85	6.8	8	15.6	57×10 ⁻⁷	6	3
PK244PAR22-L	Unipolar	0.39	1.2	4.8	4	3.9			2
PK246PAR21-L	Bipolar (Series)	0.93	0.85	10	12	26	114×10 ⁻⁷	6	3
PK246PAR22-L	Unipolar	0.75	1.2	7.2	6	6.5			2

How to read specifications table → Page 78

- Degree of Protection: IP30 (Excluding the encoder)
- "R21" and "R22" in the model name indicate the encoder resolution.
R21: 200 pulses/revolution
R22: 400 pulses/revolution

Dimensions (Unit = mm)

Model	Motor Model	L1	L2	Mass kg
PK244PAR21-L	PK244PAR21	39	57.3	0.32
PK244PAR22-L	PK244PAR22			
PK246PAR21-L	PK246PAR21	59	77.3	0.52
PK246PAR22-L	PK246PAR22			

- Applicable Motor Connector
Connector Housing: 51103-0600 (MOLEX)
Contact: 50351-8100 (MOLEX)
Crimp Tool: 57295-5000 (MOLEX)

- Applicable Encoder Connector

Connector Model	Manufacturer
640442-5	Tyco Electronics AMP
HEDS-8903 (For 3-Channel: 5-lead wires)	Avago Technologies Limited
2695 Series (Housing)	Molex
2759 Series (Contact)	

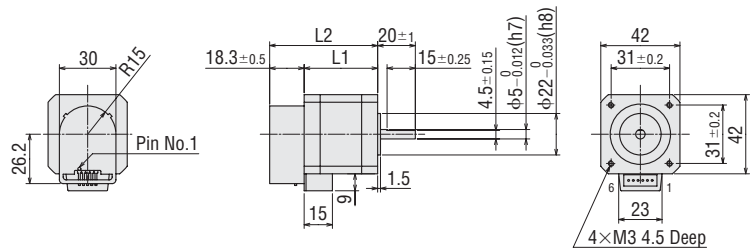

- Motor Lead Wire/Connector Assembly (Included)

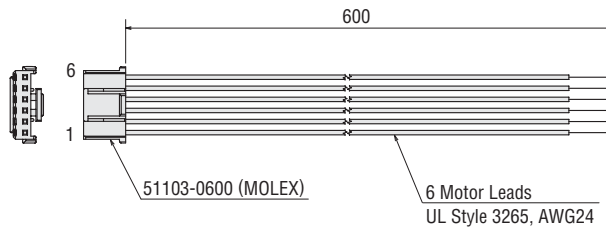

- Encoder Lead Wire/Connector Assembly (Included)

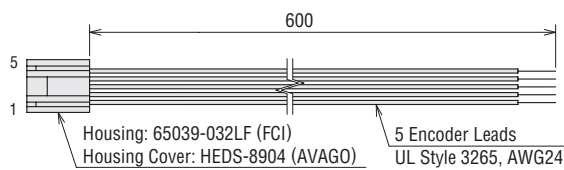

Encoder Specifications

→ Page 72

High-Efficiency	28 mm
High-Torque	35 mm
Standard	42 mm
Cable Type	IP54
Terminal Box	IP65
High-Resolution	56.4 mm
PL Geared	60 mm
TH Geared	85 mm
SH Geared	90 mm
2-Phase	Motor & Driver Package
5-Phase	Motor & Driver Package
Lead Wire/Connector	Accessories
Coupling	Accessories
Damper	Accessories
Mounting Bracket	Accessories

Speed – Torque Characteristics

How to read speed – torque characteristics → Page 79

PK244PDA-L/PK244PDB-L

Bipolar

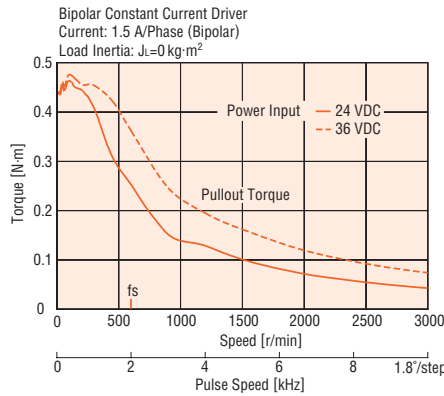

PK246PDA-L/PK246PDB-L

Bipolar

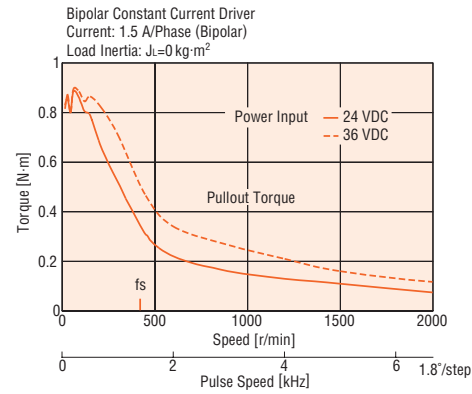

PK244PA-L/PK244PB-L

PK244PAR21-L/PK244PAR22-L

Bipolar (Series)

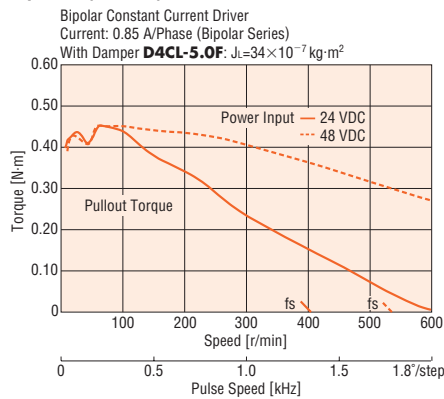

PK246PA-L/PK246PB-L

PK246PAR21-L/PK246PAR22-L

Bipolar (Series)

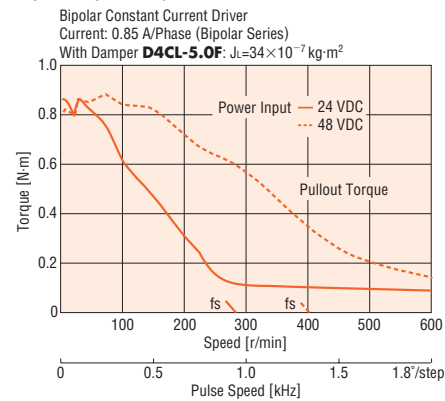

PK244PA-L/PK244PB-L

PK244PAR21-L/PK244PAR22-L

Unipolar

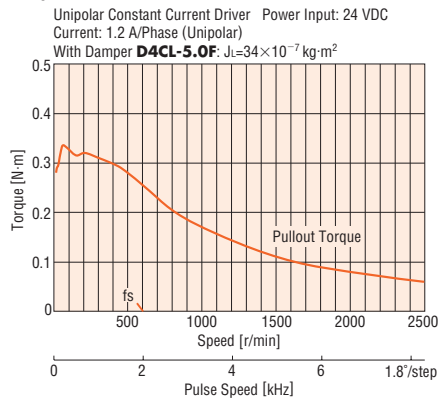

PK246PA-L/PK246PB-L

PK246PAR21-L/PK246PAR22-L

Unipolar

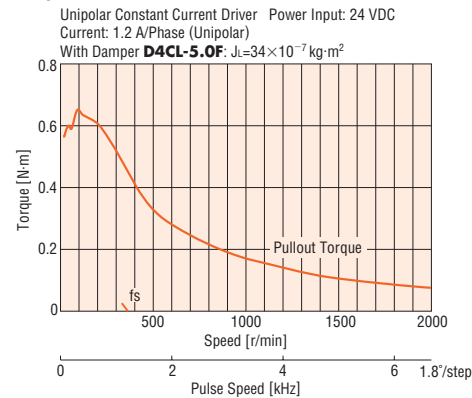

Note:

● Pay attention to heat dissipation from motor as there will be a considerable amount of heat under certain conditions. Be sure to keep the temperature of the motor case under 100°C.

Accessories (Sold separately)

If you select a product without motor lead wire/connector assembly (motor alone), applicable connector and lead wires must be furnished separately. They are available as an option.

● Motor Lead Wire/Connector Assembly → Page 90

● Motor Connector Set → Page 90

42 mm

Step Angle 1.8°
Standard Type

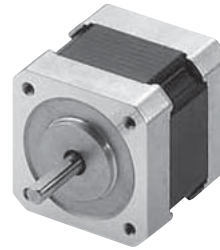

Specifications (RoHS)

Model Single Shaft Double Shaft	Connection Type	Holding Torque N·m	Current per Phase A/phase	Voltage V	Resistance per Phase Ω/phase	Inductance mH/phase	Rotor Inertia J: kg·m ²	Lead Wires	Wirings and Connections (See Page 76)	Corresponding Motor & Driver Package	
										Model	Page
PK243DA PK243DB	Bipolar	0.2	1.5	2.4	1.6	1.75	35×10 ⁻⁷	4	[1]	-	-
PK243-01A PK243-01B	Bipolar (Series)	0.2	0.67	5.6	8.4	10	35×10 ⁻⁷	6	[3]	-	-
	Unipolar	0.16	0.95	4	4.2	2.5			[2]	CMK243AP CMK243BP	P.82
PK243-02A PK243-02B	Bipolar (Series)	0.2	0.28	13	48	60	35×10 ⁻⁷	6	[3]	-	-
	Unipolar	0.16	0.4	9.6	24	15			[2]	-	-
PK243-03A PK243-03B	Bipolar (Series)	0.2	0.22	17	77	84	35×10 ⁻⁷	6	[3]	-	-
	Unipolar	0.16	0.31	12	38.5	21			[2]	-	-
PK244DA PK244DB	Bipolar	0.33	1.5	3.45	2.3	3.9	54×10 ⁻⁷	4	[1]	-	-
PK244-01A PK244-01B	Bipolar (Series)	0.33	0.85	5.6	6.6	12.8	54×10 ⁻⁷	6	[3]	-	-
	Unipolar	0.26	1.2	4	3.3	3.2			[2]	CMK244AP CMK244BP	P.82
PK244-02A PK244-02B	Bipolar (Series)	0.33	0.57	8.6	15	26.8	54×10 ⁻⁷	6	[3]	-	-
	Unipolar	0.26	0.8	6	7.5	6.7			[2]	-	-
PK244-03A PK244-03B	Bipolar (Series)	0.33	0.28	17	60	120	54×10 ⁻⁷	6	[3]	-	-
	Unipolar	0.26	0.4	12	30	30			[2]	-	-
PK245DA PK245DB	Bipolar	0.43	1.5	3.15	2.1	3.1	68×10 ⁻⁷	4	[1]	-	-
PK245-01A PK245-01B	Bipolar (Series)	0.43	0.85	5.6	6.6	11.2	68×10 ⁻⁷	6	[3]	-	-
	Unipolar	0.32	1.2	4	3.3	2.8			[2]	CMK245AP CMK245BP	P.82
PK245-02A PK245-02B	Bipolar (Series)	0.43	0.57	8.6	15	28.4	68×10 ⁻⁷	6	[3]	-	-
	Unipolar	0.32	0.8	6	7.5	7.1			[2]	-	-
PK245-03A PK245-03B	Bipolar (Series)	0.43	0.28	17	60	100	68×10 ⁻⁷	6	[3]	-	-
	Unipolar	0.32	0.4	12	30	25			[2]	-	-

How to read specifications table → Page 78

● Degree of Protection: IP30

Dimensions (Unit = mm)

Model	L1	L2	Mass kg
PK243DA PK243-0□A	33	-	0.21
PK243DB PK243-0□B		48	
PK244DA PK244-0□A	39	-	0.27
PK244DB PK244-0□B		54	
PK245DA PK245-0□A	47	-	0.35
PK245DB PK245-0□B		62	

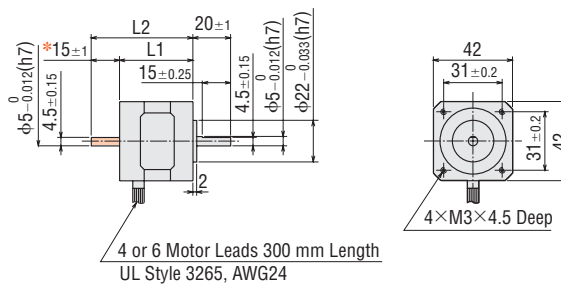

*The length of machining on double shaft model is 15±0.25.

● These dimensions are for double shaft models. For single shaft models, ignore the orange (□) areas.

● Enter the winding specifications in the box (□) within the model name.

High-Efficiency	28 mm
High-Torque	35 mm
Standard	42 mm
Cable Type	IP54
Terminal Box	IP55
High-Resolution	56.4 mm
PL Geared	60 mm
TH Geared	85 mm
SH Geared	90 mm
2-Phase	Motor & Driver Package
5-Phase	Motor & Driver Package
Lead Wire/Connector	Accessories
Coupling	Accessories
Damper	Accessories
Mounting Bracket	Accessories

42 mm

Step Angle 1.8°
Standard Type with Encoder

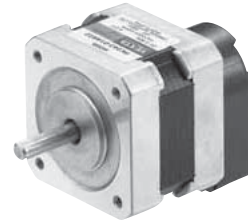

Specifications (RoHS)

Model Single Shaft	Connection Type	Holding Torque N-m	Current per Phase A/phase	Voltage V	Resistance per Phase Ω/phase	Inductance mH/phase	Rotor Inertia J: kg-m ²	Lead Wires	Wirings and Connections (See Page 76)
PK243-01AR21-L* PK243-01AR21	Bipolar (Series)	0.2	0.67	5.6	8.4	10	35×10 ⁻⁷	6	③
PK243-01AR22-L* PK243-01AR22	Unipolar	0.16	0.95	4	4.2	2.5			②
PK243-02AR21-L* PK243-02AR21	Bipolar (Series)	0.2	0.28	13	48	60	35×10 ⁻⁷	6	③
PK243-02AR22-L* PK243-02AR22	Unipolar	0.16	0.4	9.6	24	15			②
PK243-03AR21-L* PK243-03AR21	Bipolar (Series)	0.2	0.22	17	77	84	35×10 ⁻⁷	6	③
PK243-03AR22-L* PK243-03AR22	Unipolar	0.16	0.31	12	38.5	21			②
PK244-01AR21-L* PK244-01AR21	Bipolar (Series)	0.33	0.85	5.6	6.6	12.8	54×10 ⁻⁷	6	③
PK244-01AR22-L* PK244-01AR22	Unipolar	0.26	1.2	4	3.3	3.2			②
PK244-02AR21-L* PK244-02AR21	Bipolar (Series)	0.33	0.57	8.6	15	26.8	54×10 ⁻⁷	6	③
PK244-02AR22-L* PK244-02AR22	Unipolar	0.26	0.8	6	7.5	6.7			②
PK244-03AR21-L* PK244-03AR21	Bipolar (Series)	0.33	0.28	17	60	120	54×10 ⁻⁷	6	③
PK244-03AR22-L* PK244-03AR22	Unipolar	0.26	0.4	12	30	30			②
PK245-01AR21-L* PK245-01AR21	Bipolar (Series)	0.43	0.85	5.6	6.6	11.2	68×10 ⁻⁷	6	③
PK245-01AR22-L* PK245-01AR22	Unipolar	0.32	1.2	4	3.3	2.8			②
PK245-02AR21-L* PK245-02AR21	Bipolar (Series)	0.43	0.57	8.6	15	28.4	68×10 ⁻⁷	6	③
PK245-02AR22-L* PK245-02AR22	Unipolar	0.32	0.8	6	7.5	7.1			②
PK245-03AR21-L* PK245-03AR21	Bipolar (Series)	0.43	0.28	17	60	100	68×10 ⁻⁷	6	③
PK245-03AR22-L* PK245-03AR22	Unipolar	0.32	0.4	12	30	25			②

How to read specifications table → Page 78

● Degree of Protection: IP30 (Excluding the encoder)

● "R21" and "R22" in the model name indicate the encoder resolution.

R21: 200 pulses/revolution R22: 400 pulses/revolution

* Encoder lead wire/connector assembly of 0.6 m is included with the product which have "-L" at the end of the model name.

Encoder lead wire/connector assembly is not included with the product that has no "-L" at the end of the model name.

Dimensions (Unit = mm)

Model	Motor Model	L1	L2	Mass kg
PK243-0□AR21-L PK243-0□AR21	PK243-0□AR21	33	51.3	0.24
PK243-0□AR22-L PK243-0□AR22	PK243-0□AR22			
PK244-0□AR21-L PK244-0□AR21	PK244-0□AR21	39	57.3	0.29
PK244-0□AR22-L PK244-0□AR22	PK244-0□AR22			
PK245-0□AR21-L PK245-0□AR21	PK245-0□AR21	47	65.3	0.37
PK245-0□AR22-L PK245-0□AR22	PK245-0□AR22			

● Enter the winding specifications in the box (□) within the model name.

● Applicable Encoder Connector

Connector Model	Manufacturer
640442-5	Tyco Electronics AMP
HEDS-8903 (For 3-Channel: 5-lead wires)	Avago Technologies Limited
2695 Series (Housing)	Molex
2759 Series (Contact)	

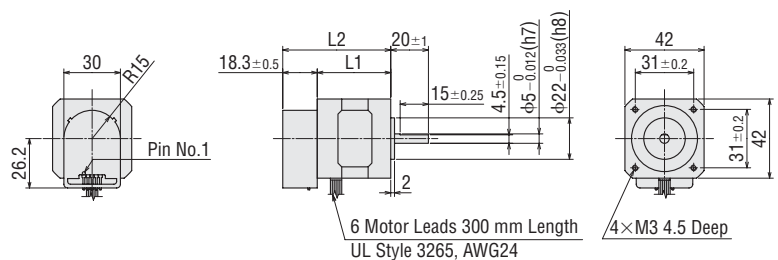

● Encoder Lead Wire/Connector Assembly (Included with the product which have "-L" at the end of the model name).

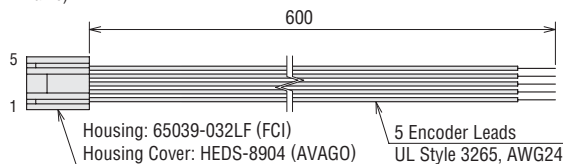

Encoder Specifications

→ Page 72

Speed – Torque Characteristics

How to read speed – torque characteristics → Page 79

PK243DA/PK243DB

Bipolar

Bipolar Constant Current Driver Power Input: 24 VDC
Current: 1.5 A/Phase (Bipolar)
Load Inertia: $J_L=0 \text{ kg}\cdot\text{m}^2$

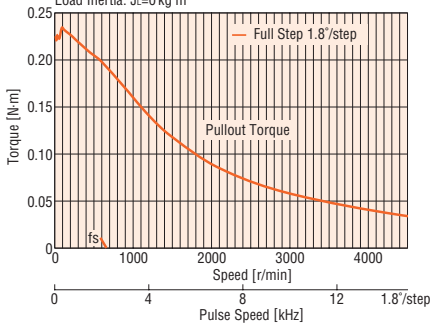

PK243-01A/PK243-01B

PK243-01AR21-L/PK243-01AR22-L

Bipolar (Series)

Bipolar Constant Current Driver
Current: 0.67 A/Phase (Bipolar Series)
With Damper **D4CL-5.0F**: $J_L=34 \times 10^{-7} \text{ kg}\cdot\text{m}^2$

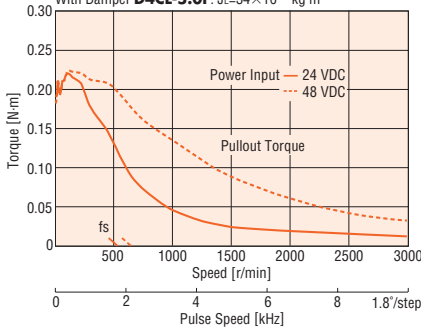

PK243-01A/PK243-01B

PK243-01AR21-L/PK243-01AR22-L

Unipolar

Unipolar Constant Current Driver Power Input: 24 VDC
Current: 0.95 A/Phase (Unipolar)
With Damper **D4CL-5.0F**: $J_L=34 \times 10^{-7} \text{ kg}\cdot\text{m}^2$

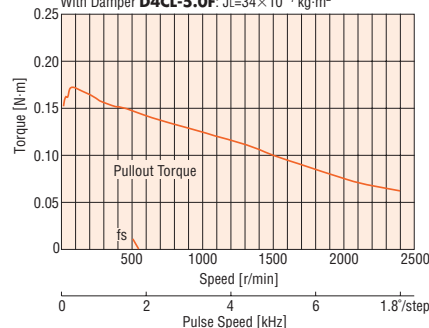

PK243-02A/PK243-02B

PK243-02AR21-L/PK243-02AR22-L

Bipolar (Series)

Bipolar Constant Current Driver
Current: 0.28 A/Phase (Bipolar Series)
With Damper **D4CL-5.0F**: $J_L=34 \times 10^{-7} \text{ kg}\cdot\text{m}^2$

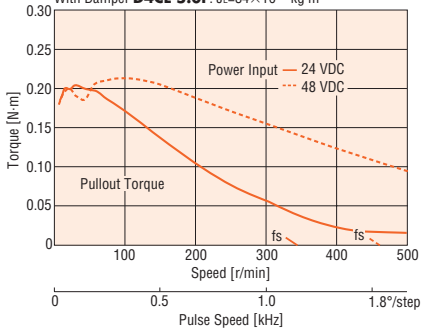

PK243-02A/PK243-02B

PK243-02AR21-L/PK243-02AR22-L

Unipolar

Unipolar Constant Voltage Driver Power Input: 11.5 VDC
External Resistance: 0 Ω
With Damper **D4CL-5.0F**: $J_L=34 \times 10^{-7} \text{ kg}\cdot\text{m}^2$

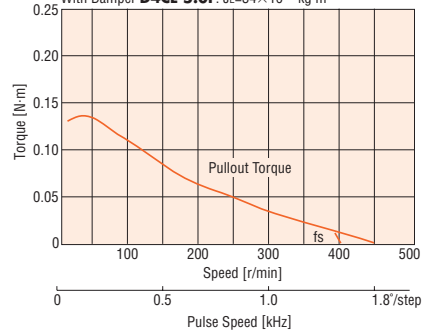

PK243-03A/PK243-03B

PK243-03AR21-L/PK243-03AR22-L

Bipolar (Series)

Bipolar Constant Current Driver
Current: 0.22 A/Phase (Bipolar Series)
With Damper **D4CL-5.0F**: $J_L=34 \times 10^{-7} \text{ kg}\cdot\text{m}^2$

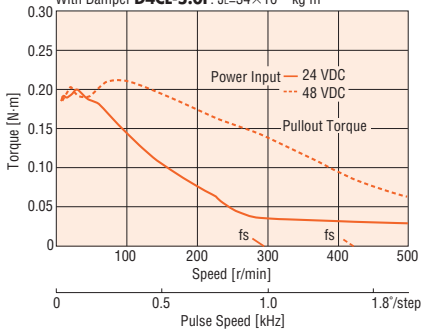

PK243-03A/PK243-03B

PK243-03AR21-L/PK243-03AR22-L

Unipolar

Unipolar Constant Voltage Driver Power Input: 13.6 VDC
External Resistance: 0 Ω
With Damper **D4CL-5.0F**: $J_L=34 \times 10^{-7} \text{ kg}\cdot\text{m}^2$

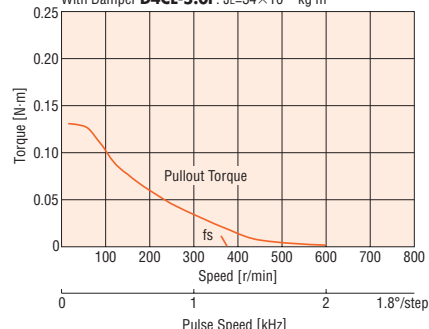

Note:

● Pay attention to heat dissipation from motor as there will be a considerable amount of heat under certain conditions. Be sure to keep the temperature of the motor case under 100°C.

High-Efficiency	28 mm
High-Torque	35 mm
Standard	42 mm
IP54 Cable Type	50 mm
IP65 Terminal Box	56.4 mm
High-Resolution	60 mm
PL Geared	85 mm
TH Geared	90 mm
SH Geared	90 mm
2-Phase	Motor & Driver Package
5-Phase	Motor & Driver Package
Lead Wire/Connector	Accessories
Coupling	
Damper	
Mounting Bracket	

PK244DA/PK244DB

Bipolar

Bipolar Constant Current Driver Power Input: 24 VDC
 Current: 1.5 A/Phase (Bipolar)
 Load Inertia: $J_L=0 \text{ kg}\cdot\text{m}^2$

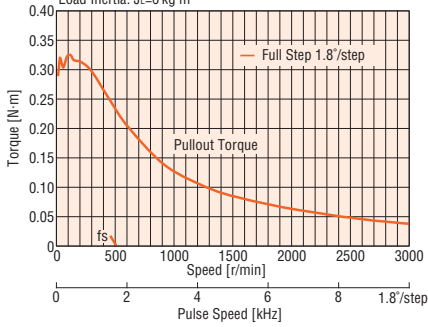

PK244-01A/PK244-01B

PK244-01AR21-L/PK244-01AR22-L

Bipolar (Series)

Bipolar Constant Current Driver
 Current: 0.85 A/Phase (Bipolar Series)
 With Damper **D4CL-5.0F**: $J_L=34 \times 10^{-7} \text{ kg}\cdot\text{m}^2$

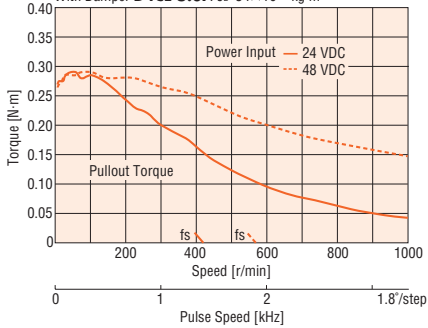

PK244-01A/PK244-01B

PK244-01AR21-L/PK244-01AR22-L

Unipolar

Unipolar Constant Current Driver Power Input: 24 VDC
 Current: 1.2 A/Phase (Unipolar)
 With Damper **D4CL-5.0F**: $J_L=34 \times 10^{-7} \text{ kg}\cdot\text{m}^2$

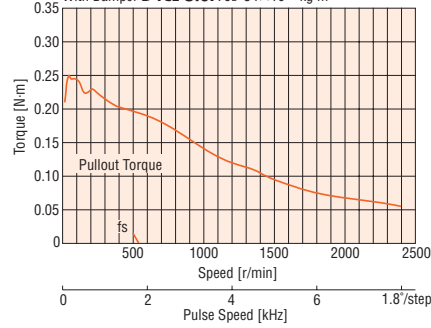

PK244-02A/PK244-02B

PK244-02AR21-L/PK244-02AR22-L

Bipolar (Series)

Bipolar Constant Current Driver
 Current: 0.57 A/Phase (Bipolar Series)
 With Damper **D4CL-5.0F**: $J_L=34 \times 10^{-7} \text{ kg}\cdot\text{m}^2$

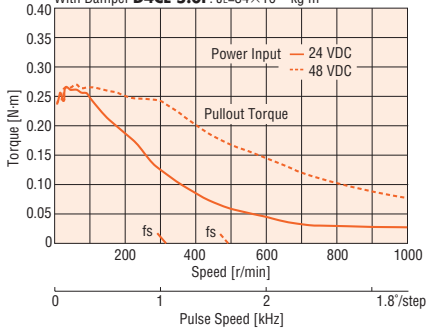

PK244-02A/PK244-02B

PK244-02AR21-L/PK244-02AR22-L

Unipolar

Unipolar Constant Current Driver Power Input: 24 VDC
 Current: 0.8 A/Phase (Unipolar)
 With Damper **D4CL-5.0F**: $J_L=34 \times 10^{-7} \text{ kg}\cdot\text{m}^2$

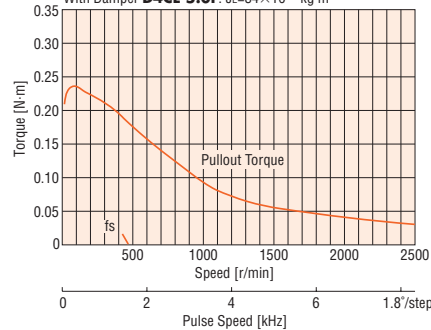

PK244-03A/PK244-03B

PK244-03AR21-L/PK244-03AR22-L

Unipolar

Unipolar Constant Voltage Driver Power Input: 13.7 VDC
 External Resistance: 0Ω
 With Damper **D4CL-5.0F**: $J_L=34 \times 10^{-7} \text{ kg}\cdot\text{m}^2$

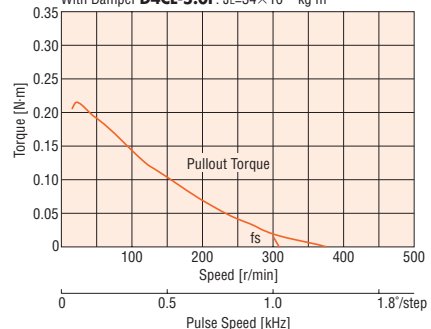

Note:

● Pay attention to heat dissipation from motor as there will be a considerable amount of heat under certain conditions. Be sure to keep the temperature of the motor case under 100°C.

PK245DA/PK245DB

Bipolar

Bipolar Constant Current Driver Power Input: 24 VDC
 Current: 1.5 A/Phase (Bipolar)
 Load Inertia: $J_L=0 \text{ kg}\cdot\text{m}^2$

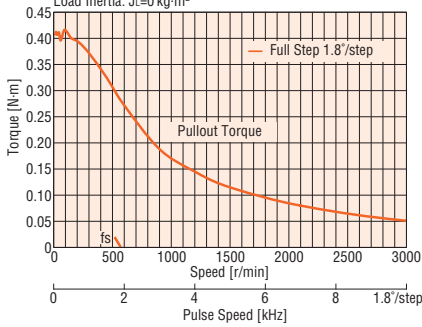

PK245-01A/PK245-01B

PK245-01AR21-L/PK245-01AR22-L

Bipolar (Series)

Bipolar Constant Current Driver
 Current: 0.85 A/Phase (Bipolar Series)
 With Damper **D4CL-5.0F**: $J_L=34 \times 10^{-7} \text{ kg}\cdot\text{m}^2$

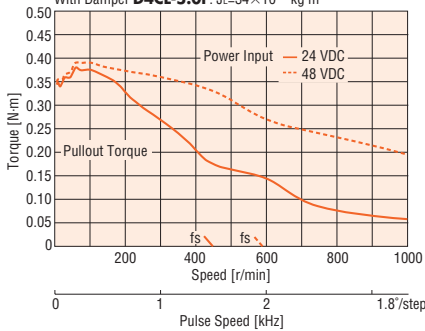

PK245-02A/PK245-02B

PK245-02AR21-L/PK245-02AR22-L

Bipolar (Series)

Bipolar Constant Current Driver
 Current: 0.57 A/Phase (Bipolar Series)
 With Damper **D4CL-5.0F**: $J_L=34 \times 10^{-7} \text{ kg}\cdot\text{m}^2$

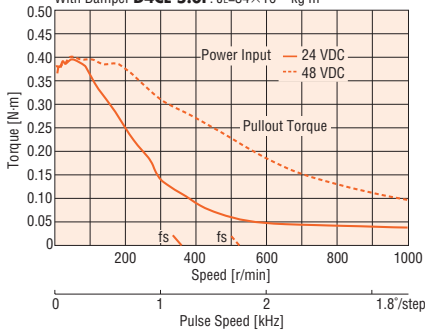

PK245-01A/PK245-01B

PK245-01AR21-L/PK245-01AR22-L

Unipolar

Unipolar Constant Current Driver Power Input: 24 VDC
 Current: 1.2 A/Phase (Unipolar)
 With Damper **D4CL-5.0F**: $J_L=34 \times 10^{-7} \text{ kg}\cdot\text{m}^2$

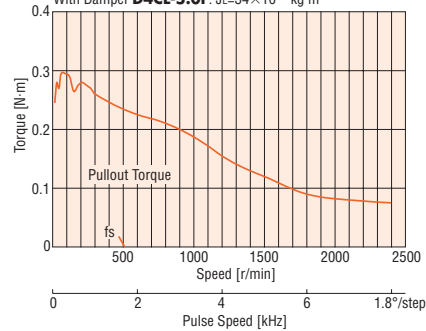

PK245-02A/PK245-02B

PK245-02AR21-L/PK245-02AR22-L

Unipolar

Unipolar Constant Current Driver Power Input: 24 VDC
 Current: 0.8 A/Phase (Unipolar)
 With Damper **D4CL-5.0F**: $J_L=34 \times 10^{-7} \text{ kg}\cdot\text{m}^2$

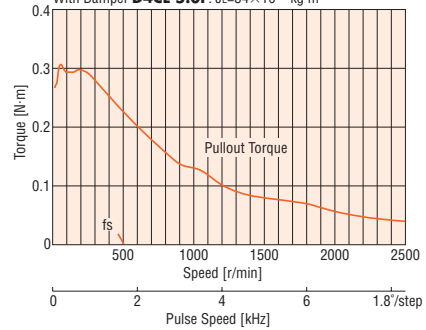

PK245-03A/PK245-03B

PK245-03AR21-L/PK245-03AR22-L

Unipolar

Unipolar Constant Voltage Driver Power Input: 13.7 VDC
 External Resistance: 0Ω
 With Damper **D4CL-5.0F**: $J_L=34 \times 10^{-7} \text{ kg}\cdot\text{m}^2$

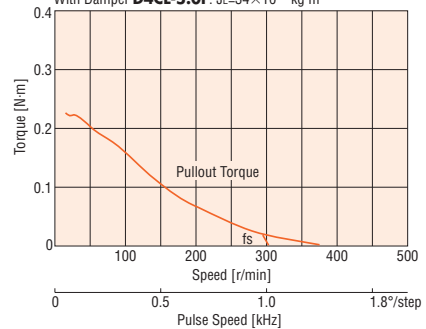

Note:

● Pay attention to heat dissipation from motor as there will be a considerable amount of heat under certain conditions. Be sure to keep the temperature of the motor case under 100°C.

High-Efficiency	28 mm
High-Torque	35 mm
Standard	42 mm
IP54 Cable Type	50 mm
IP55 Terminal Box	56.4 mm
High-Resolution	60 mm
PL Geared	85 mm
TH Geared	90 mm
SH Geared	90 mm
2-Phase	Motor & Driver Package
5-Phase	
Lead Wire/Connector	Accessories
Coupling	
Damper	
Mounting Bracket	

42 mm
 Step Angle 0.9°
 High-Resolution Type

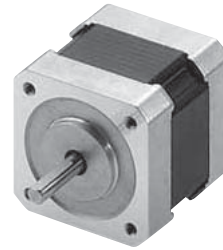

Specifications (RoHS)

Model Single Shaft Double Shaft	Connection Type	Holding Torque N·m	Current per Phase A/phase	Voltage V	Resistance per Phase Ω/phase	Inductance mH/phase	Rotor Inertia J: kg·m ²	Lead Wires	Wirings and Connections (See Page 76)	Corresponding Motor & Driver Package	
										Model	Page
PK243M-01A PK243M-01B	Bipolar (Series)	0.2	0.67	5.6	8.4	15.2	35×10 ⁻⁷	6	[3]	-	-
	Unipolar	0.16	0.95	4	4.2	3.8			[2]	CMK243MAP CMK243MBP	P.82
PK243M-02A PK243M-02B	Bipolar (Series)	0.2	0.42	8.4	20	38.8	35×10 ⁻⁷	6	[3]	-	-
	Unipolar	0.16	0.6	6	10	9.7			[2]	-	-
PK243M-03A PK243M-03B	Bipolar (Series)	0.2	0.22	17	77	136	35×10 ⁻⁷	6	[3]	-	-
	Unipolar	0.16	0.31	12	38.5	34			[2]	-	-
PK244M-01A PK244M-01B	Bipolar (Series)	0.31	0.85	5.6	6.6	17.2	54×10 ⁻⁷	6	[3]	-	-
	Unipolar	0.26	1.2	4	3.3	4.3			[2]	CMK244MAP CMK244MBP	P.82
PK244M-02A PK244M-02B	Bipolar (Series)	0.31	0.57	8.6	15	38.8	54×10 ⁻⁷	6	[3]	-	-
	Unipolar	0.26	0.8	6	7.5	9.7			[2]	-	-
PK244M-03A PK244M-03B	Bipolar (Series)	0.31	0.28	17	60	152	54×10 ⁻⁷	6	[3]	-	-
	Unipolar	0.26	0.4	12	30	38			[2]	-	-
PK245M-01A PK245M-01B	Bipolar (Series)	0.38	0.85	5.6	6.6	15.6	68×10 ⁻⁷	6	[3]	-	-
	Unipolar	0.32	1.2	4	3.3	3.9			[2]	CMK245MAP CMK245MBP	P.82
PK245M-02A PK245M-02B	Bipolar (Series)	0.38	0.57	8.6	15	39.6	68×10 ⁻⁷	6	[3]	-	-
	Unipolar	0.32	0.8	6	7.5	9.9			[2]	-	-
PK245M-03A PK245M-03B	Bipolar (Series)	0.38	0.28	17	60	128	68×10 ⁻⁷	6	[3]	-	-
	Unipolar	0.32	0.4	12	30	32			[2]	-	-

How to read specifications table → Page 78

● Degree of Protection: IP30

Dimensions (Unit = mm)

Model	L1	L2	Mass kg
PK243M-0□A	33	-	0.24
PK243M-0□B		48	
PK244M-0□A	39	-	0.3
PK244M-0□B		54	
PK245M-0□A	47	-	0.37
PK245M-0□B		62	

● Enter the winding specifications in the box (□) within the model name.

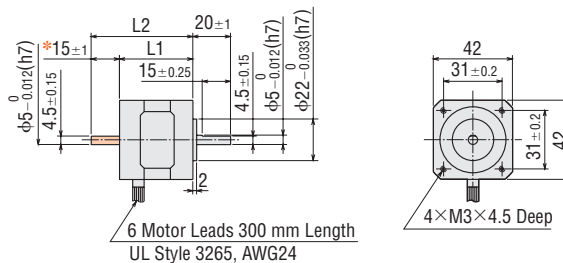

*The length of machining on double shaft model is 15±0.25.

● These dimensions are for double shaft models. For single shaft models, ignore the orange (□) areas.

42 mm

Step Angle 0.9°
High-Resolution Type with Encoder

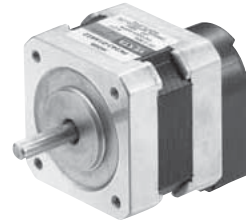

Specifications (RoHS)

Model Single Shaft	Connection Type	Holding Torque N·m	Current per Phase A/phase	Voltage V	Resistance per Phase Ω/phase	Inductance mH/phase	Rotor Inertia J: kg·m ²	Lead Wires	Wiring and Connections (See Page 76)
PK243M-01AR22-L*	Bipolar (Series)	0.2	0.67	5.6	8.4	15.2	35×10 ⁻⁷	6	③
PK243M-01AR22	Unipolar	0.16	0.95	4	4.2	3.8			②
PK243M-02AR22-L*	Bipolar (Series)	0.2	0.42	8.4	20	38.8	35×10 ⁻⁷	6	③
PK243M-02AR22	Unipolar	0.16	0.6	6	10	9.7			②
PK243M-03AR22-L*	Bipolar (Series)	0.2	0.22	17	77	136	35×10 ⁻⁷	6	③
PK243M-03AR22	Unipolar	0.16	0.31	12	38.5	34			②
PK244M-01AR22-L*	Bipolar (Series)	0.31	0.85	5.6	6.6	17.2	54×10 ⁻⁷	6	③
PK244M-01AR22	Unipolar	0.26	1.2	4	3.3	4.3			②
PK244M-02AR22-L*	Bipolar (Series)	0.31	0.57	8.6	15	38.8	54×10 ⁻⁷	6	③
PK244M-02AR22	Unipolar	0.26	0.8	6	7.5	9.7			②
PK244M-03AR22-L*	Bipolar (Series)	0.31	0.28	17	60	152	54×10 ⁻⁷	6	③
PK244M-03AR22	Unipolar	0.26	0.4	12	30	38			②
PK245M-01AR22-L*	Bipolar (Series)	0.38	0.85	5.6	6.6	15.6	68×10 ⁻⁷	6	③
PK245M-01AR22	Unipolar	0.32	1.2	4	3.3	3.9			②
PK245M-02AR22-L*	Bipolar (Series)	0.38	0.57	8.6	15	39.6	68×10 ⁻⁷	6	③
PK245M-02AR22	Unipolar	0.32	0.8	6	7.5	9.9			②
PK245M-03AR22-L*	Bipolar (Series)	0.38	0.28	17	60	128	68×10 ⁻⁷	6	③
PK245M-03AR22	Unipolar	0.32	0.4	12	30	32			②

How to read specifications table → Page 78

● Degree of Protection: IP30 (Excluding the encoder)

● "R22" in the model name indicate the encoder resolution.

R22: 400 pulses/revolution

* Encoder lead wire/connector assembly of 0.6 m is included with the product which have "-L" at the end of the model name.

Encoder lead wire/connector assembly is not included with the product that has no "-L" at the end of the model name.

Dimensions (Unit = mm)

Model	Motor Model	L1	L2	Mass kg
PK243M-0□AR22-L PK243M-0□AR22	PK243M-0□AR22	33	51.3	0.26
PK244M-0□AR22-L PK244M-0□AR22	PK244M-0□AR22	39	57.3	0.32
PK245M-0□AR22-L PK245M-0□AR22	PK245M-0□AR22	47	65.3	0.39

● Enter the winding specifications in the box (□) within the model name.

● Applicable Encoder Connector

Connector Model	Manufacturer
640442-5	Tyco Electronics AMP
HEDS-8903 (For 3-Channel: 5-lead wires)	Avago Technologies Limited
2695 Series (Housing)	Molex
2759 Series (Contact)	

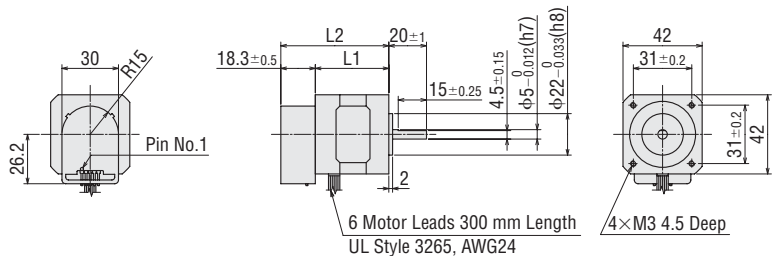

● Encoder Lead Wire/Connector Assembly (Included with the product which have "-L" at the end of the model name).

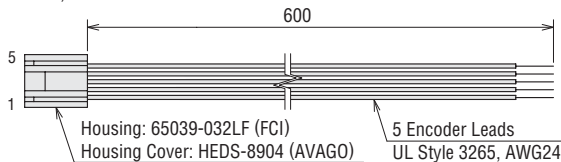

Encoder Specifications

→ Page 72

High-Efficiency	28 mm
High-Torque	35 mm
Standard	42 mm
Cable Type	IP54
Terminal Box	IP55
High-Resolution	56.4 mm
PL Geared	60 mm
TH Geared	85 mm
SH Geared	90 mm
2-Phase	Motor & Driver Package
5-Phase	Motor & Driver Package
Lead Wire/Connector	Lead Wire/Connector
Coupling	Accessories
Damper	Accessories
Mounting Bracket	Accessories

**PK243M-01A/PK243M-01B
PK243M-01AR22-L**

Bipolar (Series)

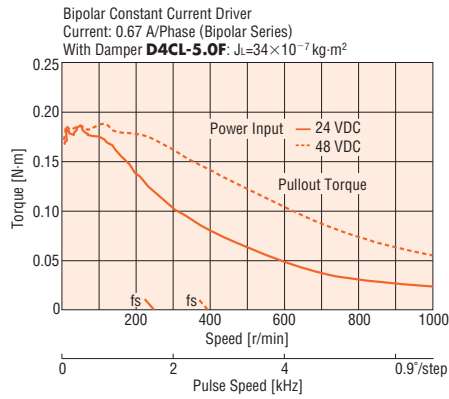

**PK243M-01A/PK243M-01B
PK243M-01AR22-L**

Unipolar

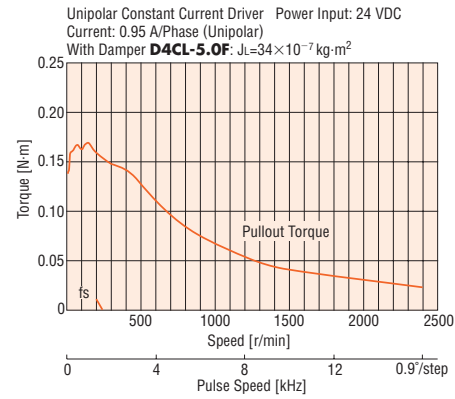

**PK243M-02A/PK243M-02B
PK243M-02AR22-L**

Bipolar (Series)

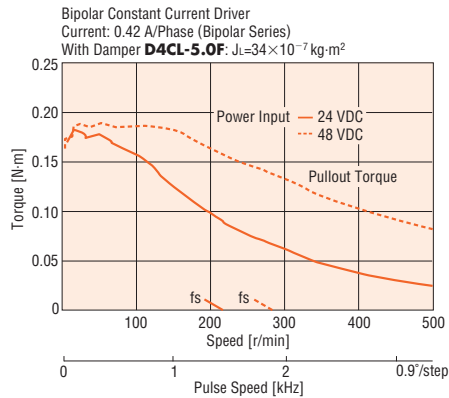

**PK243M-02A/PK243M-02B
PK243M-02AR22-L**

Unipolar

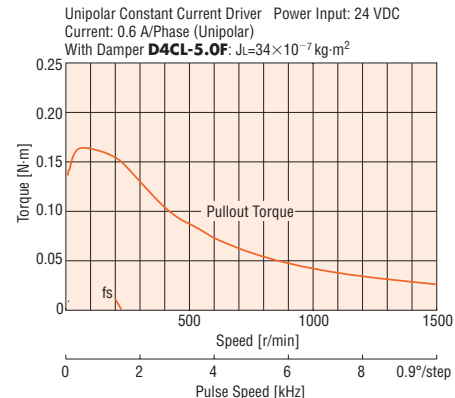

**PK243M-03A/PK243M-03B
PK243M-03AR22-L**

Bipolar (Series)

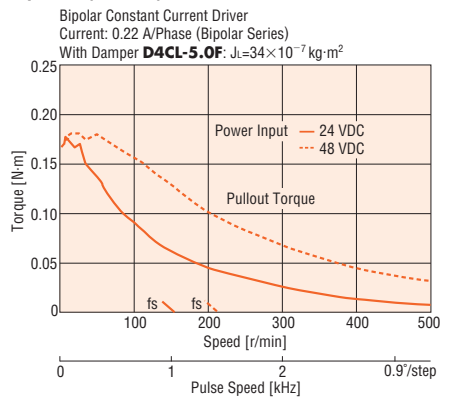

**PK243M-03A/PK243M-03B
PK243M-03AR22-L**

Unipolar

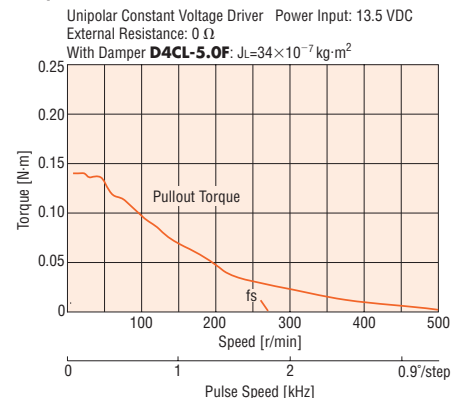

Note:

● Pay attention to heat dissipation from motor as there will be a considerable amount of heat under certain conditions. Be sure to keep the temperature of the motor case under 100°C.

PK244M-01A/PK244M-01B
PK244M-01AR22-L

Bipolar (Series)

Bipolar Constant Current Driver
 Current: 0.85 A/Phase (Bipolar Series)
 With Damper **D4CL-5.0F**: $J_L=34 \times 10^{-7} \text{ kg}\cdot\text{m}^2$

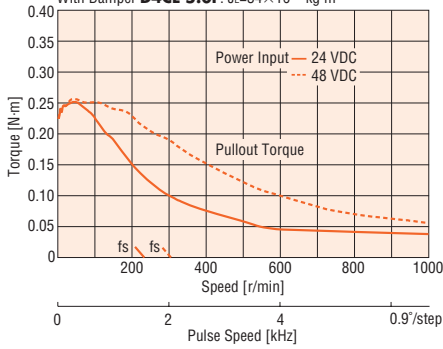

PK244M-02A/PK244M-02B
PK244M-02AR22-L

Bipolar (Series)

Bipolar Constant Current Driver
 Current: 0.57 A/Phase (Bipolar Series)
 With Damper **D4CL-5.0F**: $J_L=34 \times 10^{-7} \text{ kg}\cdot\text{m}^2$

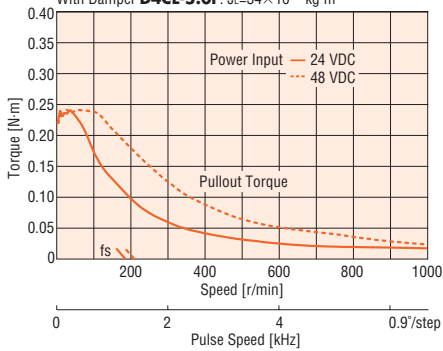

PK244M-01A/PK244M-01B
PK244M-01AR22-L

Unipolar

Unipolar Constant Current Driver Power Input: 24 VDC
 Current: 1.2 A/Phase (Unipolar)
 With Damper **D4CL-5.0F**: $J_L=34 \times 10^{-7} \text{ kg}\cdot\text{m}^2$

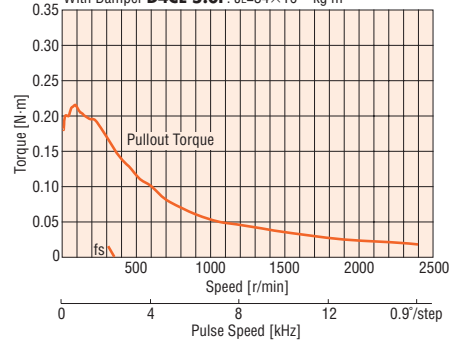

PK244M-02A/PK244M-02B
PK244M-02AR22-L

Unipolar

Unipolar Constant Current Driver Power Input: 24 VDC
 Current: 0.8 A/Phase (Unipolar)
 With Damper **D4CL-5.0F**: $J_L=34 \times 10^{-7} \text{ kg}\cdot\text{m}^2$

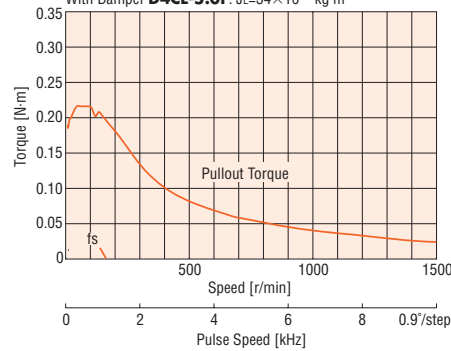

PK244M-03A/PK244M-03B
PK244M-03AR22-L

Unipolar

Unipolar Constant Voltage Driver Power Input: 13.5 VDC
 External Resistance: 0 Ω
 With Damper **D4CL-5.0F**: $J_L=34 \times 10^{-7} \text{ kg}\cdot\text{m}^2$

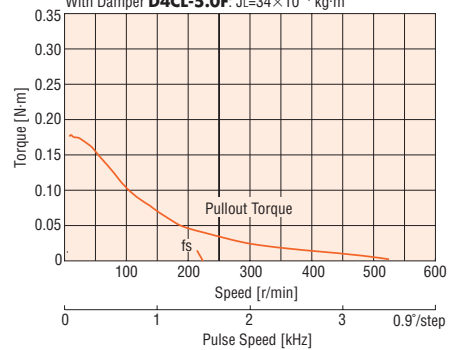

Note:

● Pay attention to heat dissipation from motor as there will be a considerable amount of heat under certain conditions. Be sure to keep the temperature of the motor case under 100°C.

High-Efficiency	<input type="checkbox"/> 28 mm
High-Torque	<input type="checkbox"/> 35 mm
Standard	<input checked="" type="checkbox"/> 42 mm
IP54 Cable Type	<input type="checkbox"/> 50 mm
Terminal Box	<input type="checkbox"/> 56.4 mm
High-Resolution	<input type="checkbox"/> 60 mm
PL Geared	<input type="checkbox"/> 85 mm
TH Geared	<input type="checkbox"/> 90 mm
SH Geared	<input type="checkbox"/> 90 mm
2-Phase	Motor & Driver Package
5-Phase	
Lead Wire/Connector	Accessories
Coupling	
Damper	
Mounting Bracket	

**PK245M-01A/PK245M-01B
PK245M-01AR22-L**

Bipolar (Series)

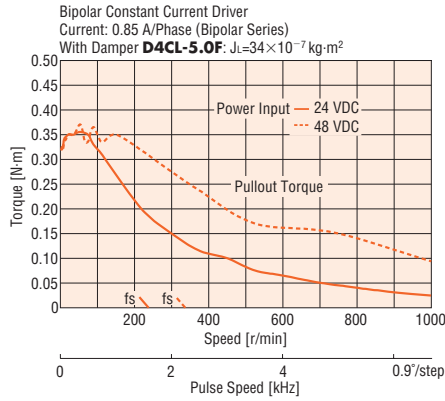

**PK245M-01A/PK245M-01B
PK245M-01AR22-L**

Unipolar

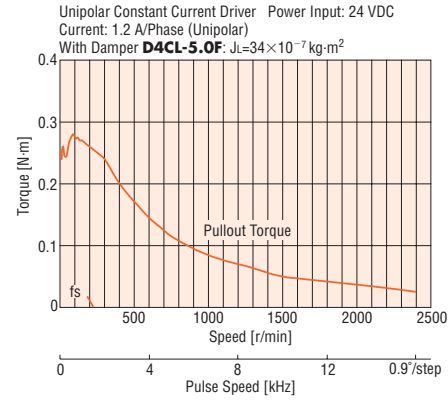

**PK245M-02A/PK245M-02B
PK245M-02AR22-L**

Bipolar (Series)

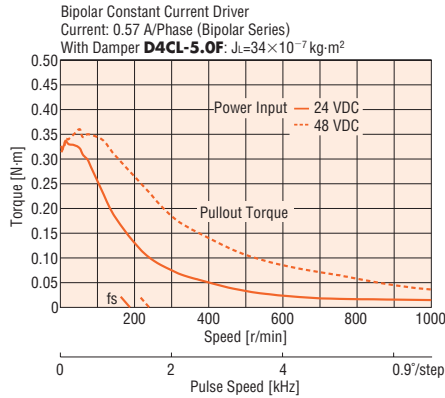

**PK245M-02A/PK245M-02B
PK245M-02AR22-L**

Unipolar

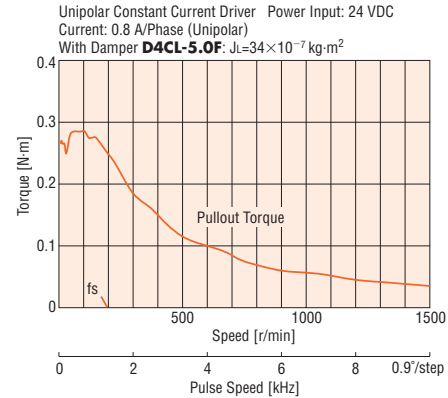

**PK245M-03A/PK245M-03B
PK245M-03AR22-L**

Unipolar

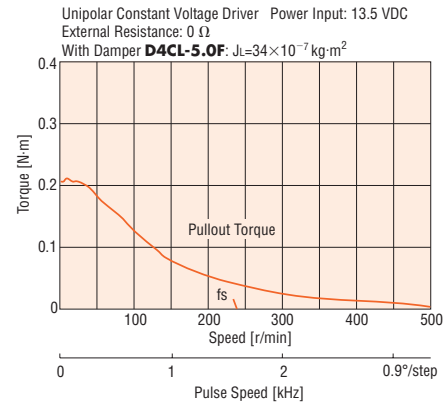

Note:

● Pay attention to heat dissipation from motor as there will be a considerable amount of heat under certain conditions. Be sure to keep the temperature of the motor case under 100°C.

<input type="checkbox"/> 28 mm	<input type="checkbox"/> 35 mm	<input checked="" type="checkbox"/> 42 mm	<input type="checkbox"/> 50 mm	<input type="checkbox"/> 56.4 mm	<input type="checkbox"/> 60 mm	<input type="checkbox"/> 85 mm	<input type="checkbox"/> 90 mm	Motor & Driver Package	Accessories				
High-Efficiency	High-Torque	Standard	IP54 Cable Type	IP55 Terminal Box	High-Resolution	PL Geared	TH Geared	SH Geared					
								2-Phase	5-Phase	Lead Wire/ Connector	Coupling	Damper	Mounting Bracket

42 mm

PL Geared Type



Specifications RoHS

Motor Specifications

Model Single Shaft Double Shaft	Connection Type	Current per Phase A/phase	Voltage V	Resistance per Phase Ω /phase	Inductance mH/phase	Rotor Inertia J: kg·m ²	Lead Wires (Pin)	Wiring and Connections (See Page 76)	Corresponding Motor & Driver Package	
									Model	Page
PK244PDA-P5-L* PK244PDA-P5 PK244PDB-P5-L* PK244PDB-P5	Bipolar	1.5	2.14	1.43	1.5	57×10^{-7}	4	①	RBK244PA-P5 RBK244PB-P5	P.80
PK244PDA-P10-L* PK244PDA-P10 PK244PDB-P10-L* PK244PDB-P10									RBK244PA-P10 RBK244PB-P10	P.80
PK244PDA-P36-L* PK244PDA-P36 PK244PDB-P36-L* PK244PDB-P36			1.2	0.8	0.47				RBK244PA-P36 RBK244PB-P36	P.80

How to read specifications table → Page 78

● Degree of Protection: IP30

* Motor lead wire/connector assembly of 0.6 m is included with the product which have "-L" at the end of the model name.
 Motor lead wire/connector assembly is not included with the product that has no "-L" at the end of the model name.

Note:

● Direction of rotation of the motor and that of the gear output shaft are the same.

Gearmotor Specifications

Model Single Shaft Double Shaft	Gear Ratio	Holding Torque N·m	Step Angle	Backlash arc min (degrees)	Permissible Speed r/min
PK244PDA-P5-L, PK244PDA-P5 PK244PDB-P5-L, PK244PDB-P5	1:5	1	0.36°	35 (0.58°)	360
PK244PDA-P10-L, PK244PDA-P10 PK244PDB-P10-L, PK244PDB-P10	1:10	1.5	0.18°		180
PK244PDA-P36-L, PK244PDA-P36 PK244PDB-P36-L, PK244PDB-P36	1:36	3	0.05°		50

Dimensions (Unit = mm)

Model	Motor Model	Gear Ratio	L1	L2	Mass kg
PK244PDA-P□-L PK244PDA-P□	PK244PDA-P□	1:5, 1:10	66.5	81.5	0.48
PK244PDB-P□-L PK244PDB-P□	PK244PDB-P□				
PK244PDA-P36-L PK244PDA-P36	PK244PDA-P36	1:36	90	105	0.6
PK244PDB-P36-L PK244PDB-P36	PK244PDB-P36				

● Enter the gear ratio in the box (□) within the model name.

● Applicable Connector

Connector Housing: 51103-0600 (Molex)

Contact: 50351-8100 (Molex)

Crimp Tool: 57295-5000 (Molex)

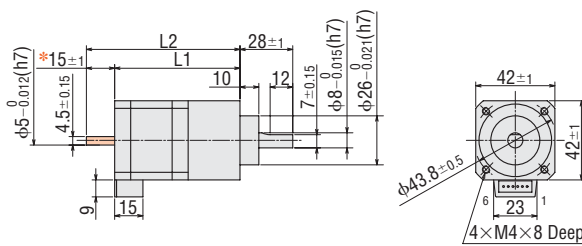

* The length of machining on double shaft model is 15 ± 0.25 .

● These dimensions are for double shaft models. For single shaft models, ignore the orange (■) areas.

● Motor Lead Wire/Connector Assembly (Included with the product which have "-L" at the end of the model name): **LC2B06B**

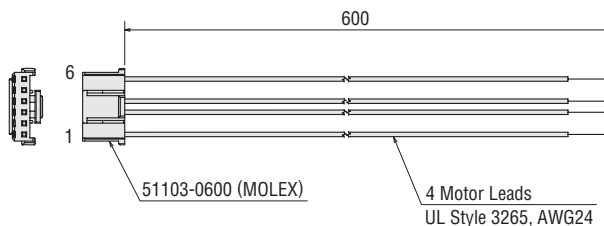

Speed – Torque Characteristics

How to read speed – torque characteristics → Page 79

PK244PDA-P□-L/PK244PDB-P□-L

Bipolar 24 VDC

Bipolar Constant Current Driver Power Input: 24 VDC
Current: 1.5 A/Phase (Bipolar)
Load Inertia: $J_L=0 \text{ kg}\cdot\text{m}^2$

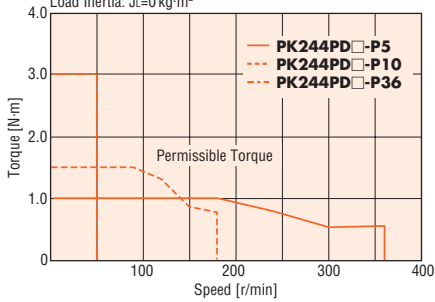

PK244PDA-P□-L/PK244PDB-P□-L

Bipolar 36 VDC

Bipolar Constant Current Driver Power Input: 36 VDC
Current: 1.5 A/Phase (Bipolar)
Load Inertia: $J_L=0 \text{ kg}\cdot\text{m}^2$

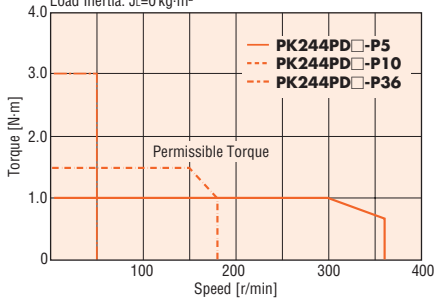

Note:

- Pay attention to heat dissipation from motor as there will be a considerable amount of heat under certain conditions. Be sure to keep the temperature of the motor case under 100°C.

Accessories (Sold separately)

If you select a product without motor lead wire/connector assembly (motor alone), applicable connector and lead wires must be furnished separately. They are available as an option.

- Motor Lead Wire/Connector Assembly → Page 90
- Motor Connector Set → Page 90

High-Efficiency	28 mm	High-Torque	35 mm	Standard	42 mm	IP54 Cable Type	50 mm	IP65 Terminal Box	56.4 mm	High-Resolution	60 mm	PI Geared	85 mm	TH Geared	90 mm	Motor & Driver Package	2-Phase	5-Phase	Lead Wire/Connector	Coupling	Damper	Mounting Bracket
-----------------	-------	-------------	-------	----------	-------	-----------------	-------	-------------------	---------	-----------------	-------	-----------	-------	-----------	-------	------------------------	---------	---------	---------------------	----------	--------	------------------

42 mm

TH Geared Type

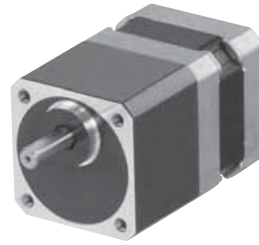

Specifications RoHS

Motor Specifications

Model Single Shaft Double Shaft	Connection Type	Current per Phase A/phase	Voltage V	Resistance per Phase Ω /phase	Inductance mH/phase	Rotor Inertia J: kg·m ²	Lead Wires	Wirings and Connections (See Page 76)	Corresponding Motor & Driver Package	
									Model	Page
PK243DA-T <input type="checkbox"/> PK243DB-T <input type="checkbox"/>	Bipolar	1.5	2.4	1.6	1.75	35×10^{-7}	4	①	–	–
PK243A1-T <input type="checkbox"/> PK243B1-T <input type="checkbox"/>	Bipolar (Series)	0.67	5.6	8.4	10	35×10^{-7}	6	③	–	–
	Unipolar	0.95	4	4.2	2.5			②	CMK243AP-T <input type="checkbox"/> CMK243BP-T <input type="checkbox"/>	P.82

How to read specifications table → Page 78

- Degree of Protection: IP30
- Enter the gear ratio in the box (□) within the model name.

Note:

- Direction of rotation of the motor and that of the gear output shaft are the same for the gear ratios 1:3.6, 1:7.2 and 1:10. It is the opposite for 1:20 and 1:30 gear ratios.

Gearmotor Specifications

Model Single Shaft Double Shaft	Gear Ratio	Holding Torque N·m	Step Angle	Backlash arc min (degrees)	Permissible Speed r/min
PK243DA-T3.6 , PK243A1-T3.6 PK243DB-T3.6 , PK243B1-T3.6	1:3.6	0.35	0.5°	45 (0.75°)	500
PK243DA-T7.2 , PK243A1-T7.2 PK243DB-T7.2 , PK243B1-T7.2	1:7.2	0.7	0.25°	25 (0.417°)	250
PK243DA-T10 , PK243A1-T10 PK243DB-T10 , PK243B1-T10	1:10	1	0.18°	25 (0.417°)	180
PK243DA-T20 , PK243A1-T20 PK243DB-T20 , PK243B1-T20	1:20	1.5	0.09°	15 (0.25°)	90
PK243DA-T30 , PK243A1-T30 PK243DB-T30 , PK243B1-T30	1:30	1.5	0.06°	15 (0.25°)	60

- Holding torque is the same regardless of the connection type, due to the permissible torque limit of the gearhead.

Dimensions (Unit = mm)

Model	Mass kg
PK243DA-T <input type="checkbox"/> PK243A1-T <input type="checkbox"/> PK243DB-T <input type="checkbox"/> PK243B1-T <input type="checkbox"/>	0.35

- Enter the gear ratio in the box (□) within the model name.

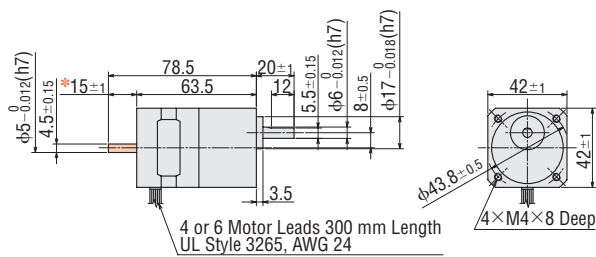

*The length of machining on double shaft model is 15 ± 0.25 .

- These dimensions are for double shaft models. For single shaft models, ignore the orange (■) areas.

Speed – Torque Characteristics

How to read speed – torque characteristics → Page 79

PK243DA-T□/PK243DB-T□

Bipolar 24 VDC

Bipolar Constant Current Driver Power Input: 24 VDC
Current: 1.5 A/Phase (Bipolar)
Load Inertia: $J_L=0 \text{ kg}\cdot\text{m}^2$

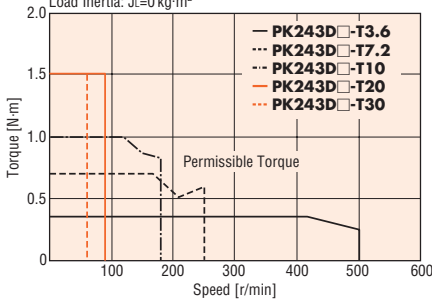

PK243DA-T□/PK243DB-T□

Bipolar 36 VDC

Bipolar Constant Current Driver Power Input: 36 VDC
Current: 1.5 A/Phase (Bipolar)
Load Inertia: $J_L=0 \text{ kg}\cdot\text{m}^2$

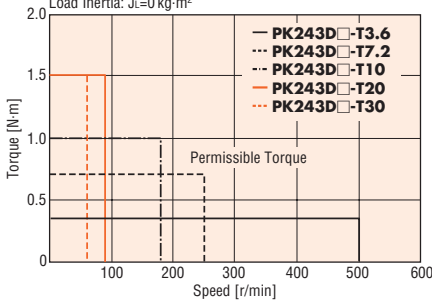

PK243A1-T□/PK243B1-T□

Bipolar (Series) 24 VDC

Bipolar Constant Current Driver Power Input: 24 VDC
Current: 0.67 A/Phase (Bipolar Series)
Load Inertia: $J_L=0 \text{ kg}\cdot\text{m}^2$

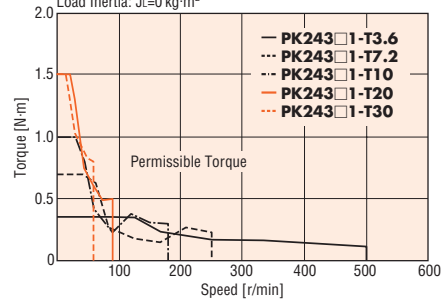

PK243A1-T□/PK243B1-T□

Bipolar (Series) 36 VDC

Bipolar Constant Current Driver Power Input: 36 VDC
Current: 0.67 A/Phase (Bipolar Series)
Load Inertia: $J_L=0 \text{ kg}\cdot\text{m}^2$

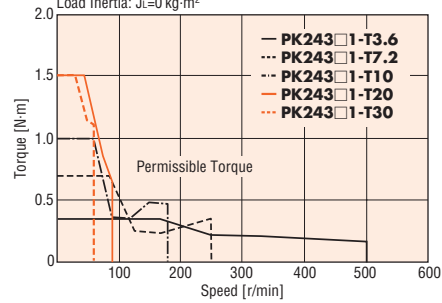

PK243A1-T□/PK243B1-T□

Unipolar 24 VDC

Unipolar Constant Current Driver Power Input: 24 VDC
Current: 0.95 A/Phase (Unipolar)
With Damper **D4CL-5.0F**: $J_L=35 \times 10^{-7} \text{ kg}\cdot\text{m}^2$

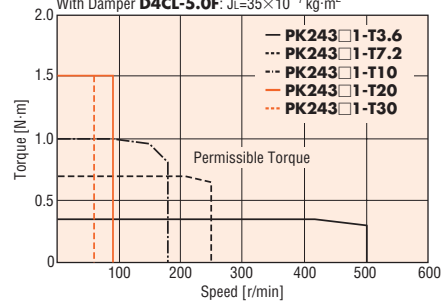

Note:

● Pay attention to heat dissipation from motor as there will be a considerable amount of heat under certain conditions. Be sure to keep the temperature of the motor case under 100°C.

High-Efficiency	□ 28 mm
High-Torque	□ 35 mm
Standard	□ 42 mm
IP54 Cable Type	□ 50 mm
Terminal Box	□ 56.4 mm
High-Resolution	□ 60 mm
PL Geared	□ 85 mm
TH Geared	□ 90 mm
SH Geared	□ 90 mm
2-Phase	Motor & Driver Package
5-Phase	Motor & Driver Package
Lead Wire/Connector	Accessories
Coupling	
Damper	
Mounting Bracket	

42 mm

SH Geared Type



Specifications RoHS

Motor Specifications

Model Single Shaft Double Shaft	Connection Type	Current per Phase A/phase	Voltage V	Resistance per Phase Ω /phase	Inductance mH/phase	Rotor Inertia J: kg·m ²	Lead Wires	Wirings and Connections (See Page 76)	Corresponding Motor & Driver Package	
									Model	Page
PK243A1-SG <input type="checkbox"/>	Bipolar (Series)	0.67	5.6	8.4	10	35×10 ⁻⁷	6	③	—	—
PK243B1-SG <input type="checkbox"/>	Unipolar	0.95	4.0	4.2	2.5				②	CMK243AP-SG <input type="checkbox"/> CMK243BP-SG <input type="checkbox"/>

How to read specifications table → Page 78

- Degree of Protection: IP30
- Enter the gear ratio in the box () within the model name.
- Backlash value is approximately 1 to 2°.

Note:

- Direction of rotation of the motor and that of the gear output shaft are the same for the gear ratios 1:3.6, 1:7.2, 1:9, 1:10, 1:50 and 1:100. It is the opposite for 1:18, and 1:36 gear ratios.

Gearmotor Specifications

Model Single Shaft Double Shaft	Gear Ratio	Holding Torque N·m	Step Angle	Permissible Speed r/min
PK243A1-SG3.6 PK243B1-SG3.6	1:3.6	0.2	0.5°	500
PK243A1-SG7.2 PK243B1-SG7.2	1:7.2	0.4	0.25°	250
PK243A1-SG9 PK243B1-SG9	1:9	0.5	0.2°	200
PK243A1-SG10 PK243B1-SG10	1:10	0.56	0.18°	180
PK243A1-SG18 PK243B1-SG18	1:18	0.8	0.1°	100
PK243A1-SG36 PK243B1-SG36	1:36	0.8	0.05°	50
PK243A1-SG50 PK243B1-SG50	1:50	0.8	0.036°	36
PK243A1-SG100 PK243B1-SG100	1:100	0.8	0.018°	18

- Holding torque is the same regardless of the connection type, due to the permissible torque limit of the gearhead.

Dimensions (Unit = mm)

Model	Mass kg
PK243A1-SG <input type="checkbox"/>	0.35
PK243B1-SG <input type="checkbox"/>	

- Enter the gear ratio in the box () within the model name.

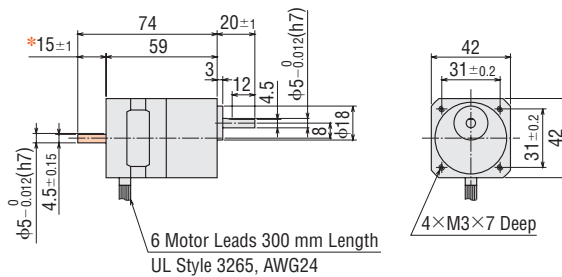

*The length of machining on double shaft model is 15±0.25.

- These dimensions are for double shaft models. For single shaft models, ignore the orange () areas.

- Screws (Included): M3 Length 10 mm—4 pieces

Speed – Torque Characteristics

How to read speed – torque characteristics → Page 79

PK243A1-SG□/PK243B1-SG□

Bipolar (Series) 24 VDC

Bipolar Constant Current Driver Power Input: 24 VDC
Current: 0.67 A/Phase (Bipolar Series)
With Damper **D4CL-5.0F**: $J_L=34 \times 10^{-7} \text{ kg}\cdot\text{m}^2$

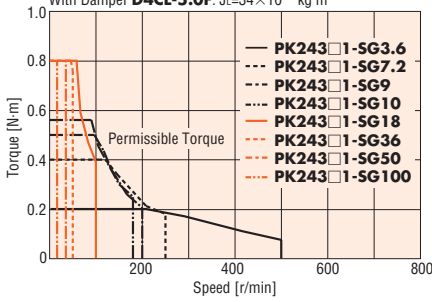

PK243A1-SG□/PK243B1-SG□

Unipolar 24 VDC

Unipolar Constant Current Driver Power Input: 24 VDC
Current: 0.95 A/Phase (Unipolar)
With Damper **D4CL-5.0F**: $J_L=34 \times 10^{-7} \text{ kg}\cdot\text{m}^2$

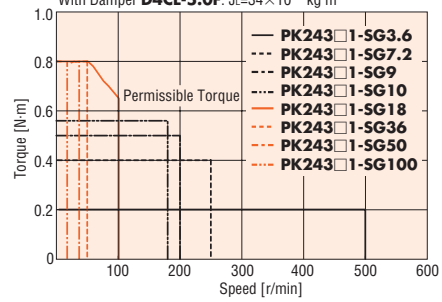

PK243A1-SG□/PK243B1-SG□

Bipolar (Series) 48 VDC

Bipolar Constant Current Driver Power Input: 48 VDC
Current: 0.67 A/Phase (Bipolar Series)
With Damper **D4CL-5.0F**: $J_L=34 \times 10^{-7} \text{ kg}\cdot\text{m}^2$

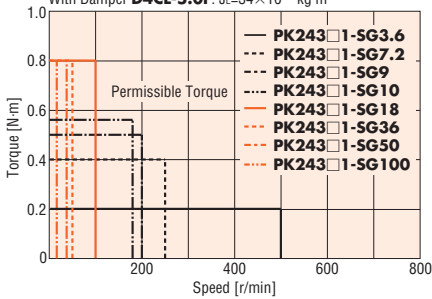

Note:

● Pay attention to heat dissipation from motor as there will be a considerable amount of heat under certain conditions. Be sure to keep the temperature of the motor case under 100°C.

High-Efficiency	□ 28 mm
High-Torque	□ 35 mm
Standard	□ 42 mm
IP54 Cable Type	□ 50 mm
Terminal Box	IP55 □ 56.4 mm
High-Resolution	□ 60 mm
PL Geared	□ 85 mm
TH Geared	□ 90 mm
SH Geared	Motor & Driver Package
2-Phase	5-Phase
Lead Wire/Connector	Coupling
Damper	Mounting Bracket
Accessories	

50 mm

Step Angle 1.8°

Standard Type

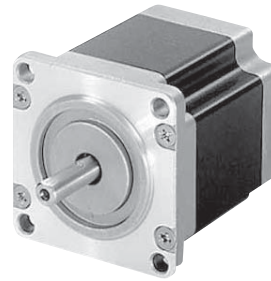

Specifications RoHS

Model Single Shaft Double Shaft	Connection Type	Holding Torque N·m	Current per Phase A/phase	Voltage V	Resistance per Phase Ω/phase	Inductance mH/phase	Rotor Inertia J: kg·m ²	Lead Wires	Wirings and Connection (See Page 76)	Corresponding Motor & Driver Package	
										Model	Page
PK256-02A PK256-02B	Bipolar (Series)	0.84	1.4	4.2	3	5.6	230×10 ⁻⁷	6	[3]	—	—
	Unipolar	0.6	2	3	1.5	1.4			[2]	CMK256AP CMK256BP	P.82
PK258-02A PK258-02B	Bipolar (Series)	1.56	1.4	6.7	4.8	11.5	420×10 ⁻⁷	6	[3]	—	—
	Unipolar	1.2	2	4.8	2.4	2.87			[2]	CMK258AP CMK258BP	P.82

How to read specifications table → Page 78

● Degree of Protection: IP30

Dimensions (Unit = mm)

Model	L1	L2	Mass kg
PK256-02A	51.5	—	0.53
PK256-02B		67.5	
PK258-02A	81	—	0.89
PK258-02B		97	

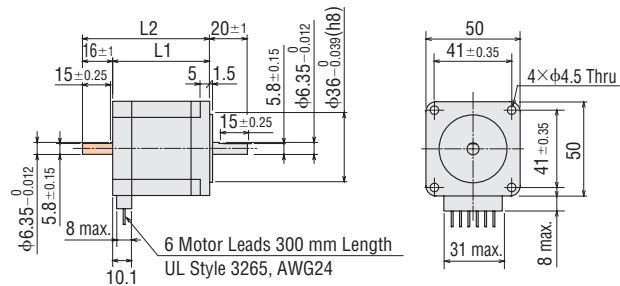

● These dimensions are for double shaft models. For single shaft models, ignore the orange (■) areas.

Speed – Torque Characteristics

How to read speed – torque characteristics → Page 79

PK256-02A/PK256-02B

Bipolar (Series)

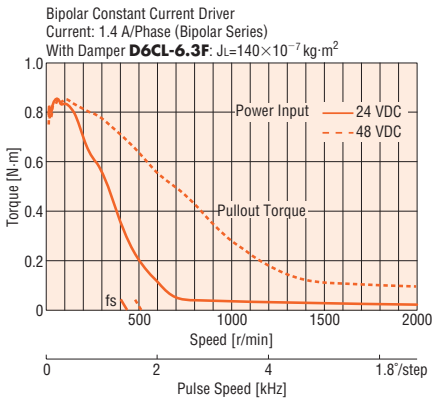

PK256-02A/PK256-02B

Unipolar

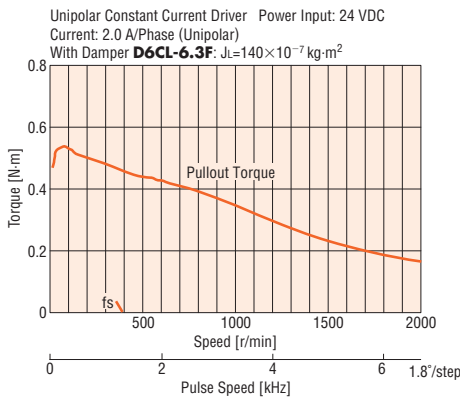

PK258-02A/PK258-02B

Bipolar (Series)

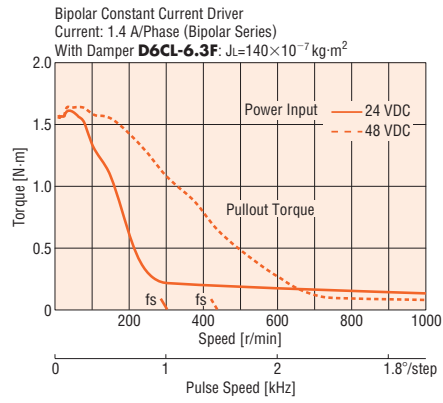

PK258-02A/PK258-02B

Unipolar

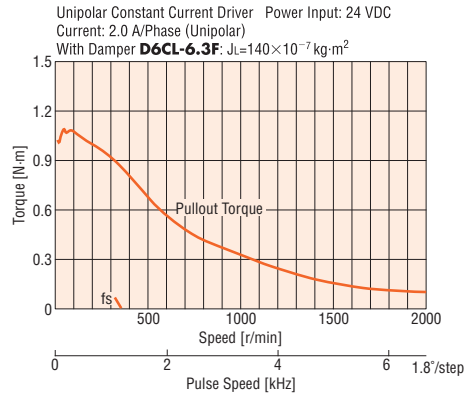

Note:

● Pay attention to heat dissipation from motor as there will be a considerable amount of heat under certain conditions. Be sure to keep the temperature of the motor case under 100°C.

High-Efficiency	<input type="checkbox"/> 28 mm
High-Torque	<input type="checkbox"/> 35 mm
Standard	<input type="checkbox"/> 42 mm
Cable Type	IP54 <input type="checkbox"/> 50 mm
Terminal Box	IP65 <input type="checkbox"/> 56.4 mm
High-Resolution	<input type="checkbox"/> 60 mm
PL Geared	<input type="checkbox"/> 85 mm
TH Geared	<input type="checkbox"/> 90 mm
SH Geared	Motor & Driver Package
2-Phase	5-Phase
Lead Wire/Connector	Accessories
Coupling	
Damper	
Mounting Bracket	

56.4 mm

Step Angle 1.8°
High-Torque Type

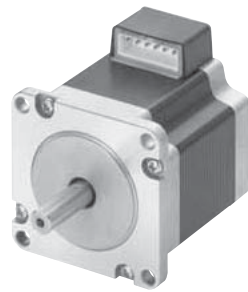

Specifications RoHS

Model Single Shaft Double Shaft	Connection Type	Holding Torque N·m	Current per Phase A/phase	Voltage V	Resistance per Phase Ω/phase	Inductance mH/phase	Rotor Inertia J: kg·m ²	Lead Wires (Pin)	Wiring and Connections (See Page 76)	Corresponding Motor & Driver Package	
										Model	Page
PK264PDA-L* PK264PDA PK264PDB-L* PK264PDB	Bipolar	0.6	2.8	2	0.73	1.8	120×10 ⁻⁷	4	①	RBK264PA RBK264PB	P.80
PK264PA-L* PK264PA PK264PB-L* PK264PB	Bipolar (Series)	0.6	1.4	4.1	2.9	7.2	120×10 ⁻⁷	6	③	—	—
	Unipolar	0.51	2	2.9	1.45	1.8			②	CMK264PAP CMK264PBP	P.82
PK266PDA-L* PK266PDA PK266PDB-L* PK266PDB	Bipolar	1.4	2.8	2.8	1	2.9	290×10 ⁻⁷	4	①	RBK266PA RBK266PB	P.80
PK266PA-L* PK266PA PK266PB-L* PK266PB	Bipolar (Series)	1.4	1.4	5.6	4	11.6	290×10 ⁻⁷	6	③	—	—
	Unipolar	1.1	2	4	2	2.9			②	CMK266PAP CMK266PBP	P.82
PK268PDA-L* PK268PDA PK268PDB-L* PK268PDB	Bipolar	2.3	2.8	3.4	1.23	4.4	490×10 ⁻⁷	4	①	RBK268PA RBK268PB	P.80
PK268PA-L* PK268PA PK268PB-L* PK268PB	Bipolar (Series)	2.3	1.4	6.9	4.9	17.6	490×10 ⁻⁷	6	③	—	—
	Unipolar	1.75	2	4.9	2.45	4.4			②	CMK268PAP CMK268PBP	P.82

How to read specifications table → Page 78

● Degree of Protection: IP30

* Motor lead wire/connector assembly of 0.6 m is included with the product which have "-L" at the end of the model name.

Motor lead wire/connector assembly is not included with the product that has no "-L" at the end of the model name.

Dimensions (Unit = mm)

Model	Motor Model	L1	L2	Mass kg
PK264PDA-L, PK264PDA	PK264PDA	39	—	0.46
PK264PA-L, PK264PA	PK264PA		—	
PK264PDB-L, PK264PDB	PK264PDB		62	
PK264PB-L, PK264PB	PK264PB	54	—	0.73
PK266PDA-L, PK266PDA	PK266PDA		—	
PK266PA-L, PK266PA	PK266PA		77	
PK266PDB-L, PK266PDB	PK266PDB	76	—	1.1
PK266PB-L, PK266PB	PK266PB		—	
PK268PDA-L, PK268PDA	PK268PDA		99	
PK268PA-L, PK268PA	PK268PA	76	—	1.1
PK268PDB-L, PK268PDB	PK268PDB		—	
PK268PB-L, PK268PB	PK268PB	99	—	—

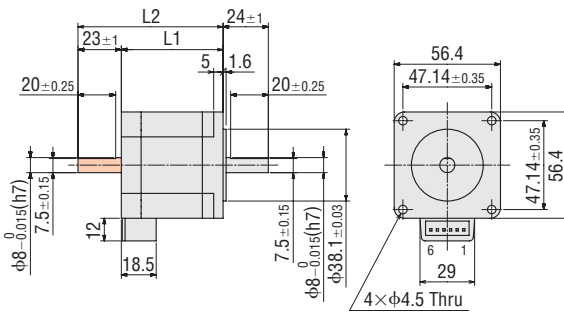

● These dimensions are for double shaft models. For single shaft models, ignore the orange (■) areas.

● Applicable Connector

Connector Housing: 51067-0600(MOLEX)

Contact: 50217-9101(MOLEX)

Crimp Tool: 57189-5000(MOLEX)

57190-5000(MOLEX)

● Motor Lead Wire/Connector Assembly (Included with the product which have "-L" at the end of the model name)

LC2B06C (Included with **PK26□P□-L**)

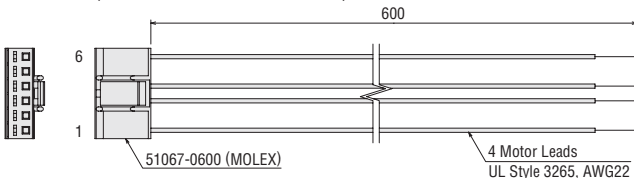

LC2U06C (Included with **PK26□P□-L**)

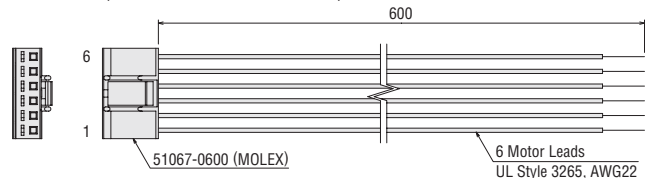

● Enter the motor case length in the box (□) within the model name.

Enter **A** (single shaft) or **B** (double shaft) in the box (■) within the model name.

PK264PDA-L/PK264PDB-L

Bipolar

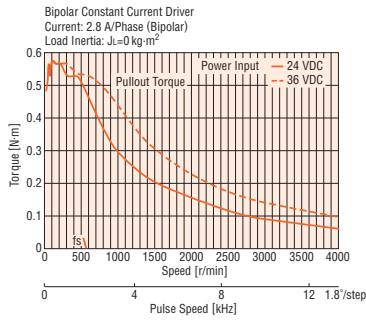

PK266PDA-L/PK266PDB-L

Bipolar

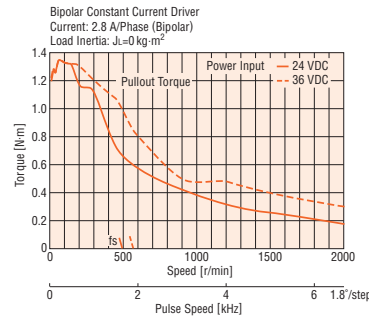

PK268PDA-L/PK268PDB-L

Bipolar

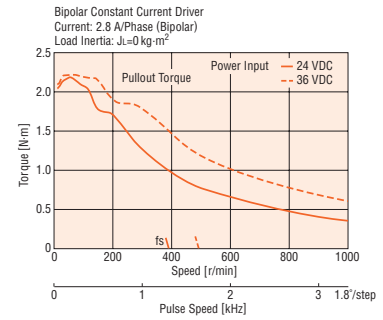

PK264PA-L/PK264PB-L

Bipolar (Series)

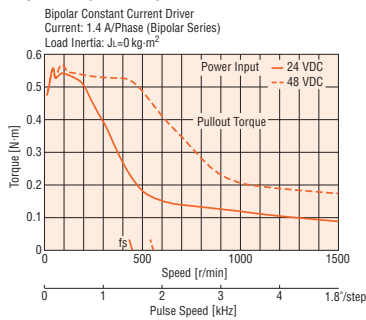

PK266PA-L/PK266PB-L

Bipolar (Series)

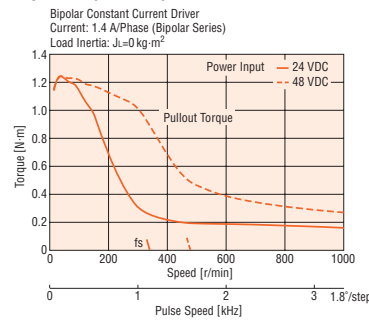

PK268PA-L/PK268PB-L

Bipolar (Series)

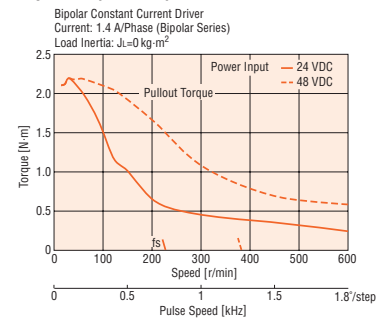

PK264PA-L/PK264PB-L

Unipolar

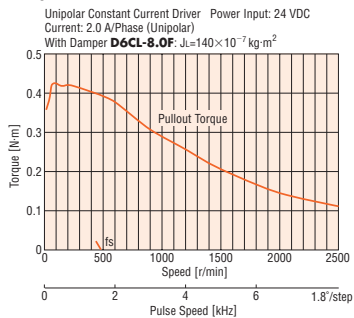

PK266PA-L/PK266PB-L

Unipolar

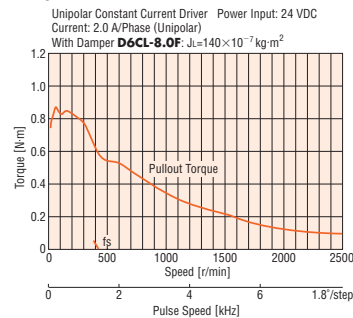

PK268PA-L/PK268PB-L

Unipolar

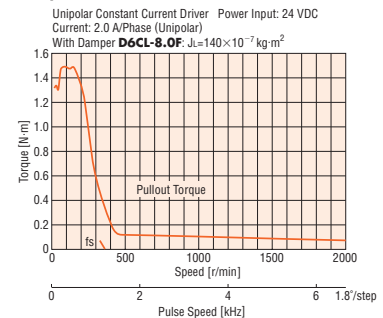

Note:

● Pay attention to heat dissipation from motor as there will be a considerable amount of heat under certain conditions. Be sure to keep the temperature of the motor case under 100°C.

Accessories (Sold separately)

If you select a product without motor lead wire/connector assembly (motor alone), applicable connector and lead wires must be furnished separately. They are available as an option.

● Motor Lead Wire/Connector Assembly → Page 90

High-Efficiency	<input type="checkbox"/> 28 mm
High-Torque	<input type="checkbox"/> 35 mm
Standard	<input type="checkbox"/> 42 mm
IP54 Cable Type	<input type="checkbox"/> 50 mm
Terminal Box	<input type="checkbox"/> 56.4 mm
High-Resolution	<input type="checkbox"/> 60 mm
PL Geared	<input type="checkbox"/> 85 mm
TH Geared	<input type="checkbox"/> 90 mm
SH Geared	<input type="checkbox"/> 90 mm
2-Phase	Motor & Driver Package
5-Phase	Motor & Driver Package
Lead Wire/Connector	Accessories
Coupling	
Damper	
Mounting Bracket	

□ 56.4 mm

Step Angle 1.8°

Standard Type

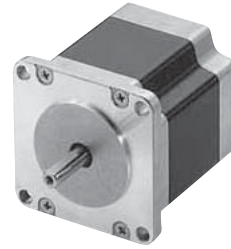

Specifications RoHS

Model Single Shaft Double Shaft	Connection Type	Holding Torque N-m	Current per Phase A/phase	Voltage V	Resistance per Phase Ω/phase	Inductance mH/phase	Rotor Inertia J: kg-m ²	Lead Wires	Wirings and Connections (See Page 76)	Corresponding Motor & Driver Package	
										Model	Page
PK264DA PK264DB	Bipolar	0.48	4.2	1.26	0.3	0.6	120×10 ⁻⁷	4	[1]	RBK264A RBK264B	P.80
PK264-01A PK264-01B	Bipolar (Series)	0.48	0.71	8.1	11.4	21.6	120×10 ⁻⁷	6	[3]	-	-
	Unipolar	0.39	1	5.7	5.7	5.4			[2]		
PK264-02A PK264-02B	Bipolar (Series)	0.48	1.4	3.9	2.8	5.6	120×10 ⁻⁷	6	[3]	CMK264AP CMK264BP	P.82
	Unipolar	0.39	2	2.8	1.4	1.4			[2]		
PK264-03A PK264-03B	Bipolar (Series)	0.48	2.1	2.6	1.26	2.4	120×10 ⁻⁷	6	[3]	-	-
	Unipolar	0.39	3	1.9	0.63	0.6			[2]		
PK264-E2.0A PK264-E2.0B	Bipolar (Parallel)	0.48	2.8	1.96	0.7	1.4	120×10 ⁻⁷	8	[6]	-	-
	Bipolar (Series)	0.48	1.4	3.9	2.8	5.6			[5]		
	Unipolar	0.39	2	2.8	1.4	1.4			[4]		
PK266DA PK266DB	Bipolar	1.17	4.2	1.68	0.4	1.1	300×10 ⁻⁷	4	[1]	RBK266A RBK266B	P.80
PK266-01A PK266-01B	Bipolar (Series)	1.17	0.71	11	14.8	40	300×10 ⁻⁷	6	[3]	-	-
	Unipolar	0.9	1	7.4	7.4	10			[2]		
PK266-02A PK266-02B	Bipolar (Series)	1.17	1.4	5	3.6	10	300×10 ⁻⁷	6	[3]	CMK266AP CMK266BP	P.82
	Unipolar	0.9	2	3.6	1.8	2.5			[2]		
PK266-03A PK266-03B	Bipolar (Series)	1.17	2.1	3.2	1.5	4.4	300×10 ⁻⁷	6	[3]	-	-
	Unipolar	0.9	3	2.3	0.75	1.1			[2]		
PK266-E2.0A PK266-E2.0B	Bipolar (Parallel)	1.17	2.8	2.52	0.9	2.5	300×10 ⁻⁷	8	[6]	-	-
	Bipolar (Series)	1.17	1.4	5	3.6	10			[5]		
	Unipolar	0.9	2	3.6	1.8	2.5			[4]		
PK268DA PK268DB	Bipolar	1.75	4.2	2.1	0.5	1.6	480×10 ⁻⁷	4	[1]	RBK268A RBK268B	P.80
PK268-01A PK268-01B	Bipolar (Series)	1.75	0.71	12	17.2	56	480×10 ⁻⁷	6	[3]	-	-
	Unipolar	1.35	1	8.6	8.6	14			[2]		
PK268-02A PK268-02B	Bipolar (Series)	1.75	1.4	6.3	4.5	14.4	480×10 ⁻⁷	6	[3]	CMK268AP CMK268BP	P.82
	Unipolar	1.35	2	4.5	2.25	3.6			[2]		
PK268-03A PK268-03B	Bipolar (Series)	1.75	2.1	4.2	2	6.4	480×10 ⁻⁷	6	[3]	-	-
	Unipolar	1.35	3	3	1	1.6			[2]		
PK268-E2.0A PK268-E2.0B	Bipolar (Parallel)	1.75	2.8	3.16	1.13	3.6	480×10 ⁻⁷	8	[6]	-	-
	Bipolar (Series)	1.75	1.4	6.3	4.5	14.4			[5]		
	Unipolar	1.35	2	4.5	2.25	3.6			[4]		

How to read specifications table → Page 78

● Degree of Protection: IP30

Dimensions (Unit = mm)

Model	L1	L2	Mass kg
PK264DA, PK264-0□A, PK264-E2.0A	39	-	0.45
PK264DB, PK264-0□B, PK264-E2.0B		55	
PK266DA, PK266-0□A, PK266-E2.0A	54	-	0.7
PK266DB, PK266-0□B, PK266-E2.0B		70	
PK268DA, PK268-0□A, PK268-E2.0A	76	-	1.0
PK268DB, PK268-0□B, PK268-E2.0B		92	

● Enter the winding specifications in the box (□) within the model name.

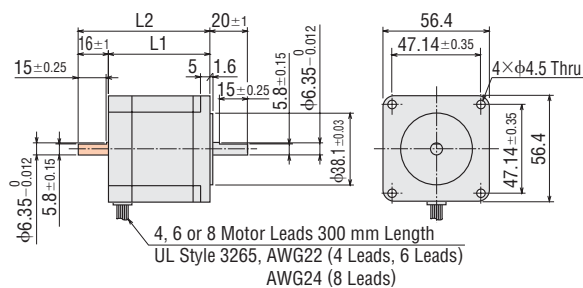

● These dimensions are for double shaft models. For single shaft models, ignore the orange (■) areas.

56.4 mm

Step Angle 1.8°
Standard Type with Encoder

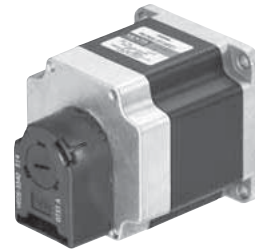

Specifications (RoHS)

Model Single Shaft	Connection Type	Holding Torque N-m	Current per Phase A/phase	Voltage V	Resistance per Phase Ω/phase	Inductance mH/phase	Rotor Inertia J: kg-m ²	Lead Wires	Wirings and Connections (See Page 76)
PK264-01AR21-L* PK264-01AR21 PK264-01AR22-L* PK264-01AR22	Bipolar (Series)	0.48	0.71	8.1	11.4	21.6	120×10 ⁻⁷	6	③
	Unipolar	0.39	1	5.7	5.7	5.4			②
PK264-02AR21-L* PK264-02AR21 PK264-02AR22-L* PK264-02AR22	Bipolar (Series)	0.48	1.4	3.9	2.8	5.6	120×10 ⁻⁷	6	③
	Unipolar	0.39	2	2.8	1.4	1.4			②
PK264-03AR21-L* PK264-03AR21 PK264-03AR22-L* PK264-03AR22	Bipolar (Series)	0.48	2.1	2.6	1.26	2.4	120×10 ⁻⁷	6	③
	Unipolar	0.39	3	1.9	0.63	0.6			②
PK264EAR21-L* PK264EAR21 PK264EAR22-L* PK264EAR22	Bipolar (Parallel)	0.48	2.8	1.96	0.7	1.4	120×10 ⁻⁷	8	⑥
	Bipolar (Series)	0.48	1.4	3.9	2.8	5.6			⑤
	Unipolar	0.39	2	2.8	1.4	1.4			④
PK266-01AR21-L* PK266-01AR21 PK266-01AR22-L* PK266-01AR22	Bipolar (Series)	1.17	0.71	11	14.8	40	300×10 ⁻⁷	6	③
	Unipolar	0.9	1	7.4	7.4	10			②
PK266-02AR21-L* PK266-02AR21 PK266-02AR22-L* PK266-02AR22	Bipolar (Series)	1.17	1.4	5	3.6	10	300×10 ⁻⁷	6	③
	Unipolar	0.9	2	3.6	1.8	2.5			②
PK266-03AR21-L* PK266-03AR21 PK266-03AR22-L* PK266-03AR22	Bipolar (Series)	1.17	2.1	3.2	1.5	4.4	300×10 ⁻⁷	6	③
	Unipolar	0.9	3	2.3	0.75	1.1			②
PK266EAR21-L* PK266EAR21 PK266EAR22-L* PK266EAR22	Bipolar (Parallel)	1.17	2.8	2.52	0.9	2.5	300×10 ⁻⁷	8	⑥
	Bipolar (Series)	1.17	1.4	5	3.6	10			⑤
	Unipolar	0.9	2	3.6	1.8	2.5			④
PK268-01AR21-L* PK268-01AR21 PK268-01AR22-L* PK268-01AR22	Bipolar (Series)	1.75	0.71	12	17.2	56	480×10 ⁻⁷	6	③
	Unipolar	1.35	1	8.6	8.6	14			②
PK268-02AR21-L* PK268-02AR21 PK268-02AR22-L* PK268-02AR22	Bipolar (Series)	1.75	1.4	6.3	4.5	14.4	480×10 ⁻⁷	6	③
	Unipolar	1.35	2	4.5	2.25	3.6			②
PK268-03AR21-L* PK268-03AR21 PK268-03AR22-L* PK268-03AR22	Bipolar (Series)	1.75	2.1	4.2	2	6.4	480×10 ⁻⁷	6	③
	Unipolar	1.35	3	3	1	1.6			②
PK268EAR21-L* PK268EAR21 PK268EAR22-L* PK268EAR22	Bipolar (Parallel)	1.75	2.8	3.16	1.13	3.6	480×10 ⁻⁷	8	⑥
	Bipolar (Series)	1.75	1.4	6.3	4.5	14.4			⑤
	Unipolar	1.35	2	4.5	2.25	3.6			④

How to read specifications table → Page 78

● Degree of Protection: IP30 (Excluding the encoder)

● "R21" and "R22" in the model name indicate the encoder resolution.

R21: 200 pulses/revolution

R22: 400 pulses/revolution

* Encoder lead wire/connector assembly of 0.6 m is included with the product which have "-L" at the end of the model name.

Encoder lead wire/connector assembly is not included with the product that has no "-L" at the end of the model name.

High-Efficiency	28 mm
High-Torque	35 mm
Standard	42 mm
IP54 Cable Type	50 mm
IP65 Terminal Box	56.4 mm
High-Resolution	60 mm
PL Geared	85 mm
TH Geared	90 mm
SH Geared	Motor & Driver Package
2-Phase	
5-Phase	
Lead Wire/Connector	Accessories
Coupling	
Damper	
Mounting Bracket	

Dimensions (Unit = mm)

Model	Motor Model	L1	L2	Mass kg
PK264-0□AR21-L, PK264-0□AR21	PK264-0□AR21	39	57.3	0.47
PK264-0□AR22-L, PK264-0□AR22	PK264-0□AR22			
PK264EAR21-L, PK264EAR21	PK264EAR21			
PK264EAR22-L, PK264EAR22	PK264EAR22			
PK266-0□AR21-L, PK266-0□AR21	PK266-0□AR21	54	72.3	0.72
PK266-0□AR22-L, PK266-0□AR22	PK266-0□AR22			
PK266EAR21-L, PK266EAR21	PK266EAR21			
PK266EAR22-L, PK266EAR22	PK266EAR22			
PK268-0□AR21-L, PK268-0□AR21	PK268-0□AR21	76	94.3	1.02
PK268-0□AR22-L, PK268-0□AR22	PK268-0□AR22			
PK268EAR21-L, PK268EAR21	PK268EAR21			
PK268EAR22-L, PK268EAR22	PK268EAR22			

● Enter the winding specifications in the box (□) within the model name.

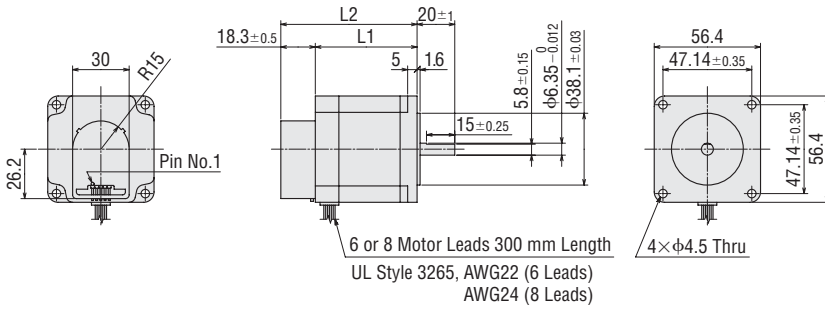

● Encoder Lead Wire/Connector Assembly (Included with the product which have "-L" at the end of the model name)

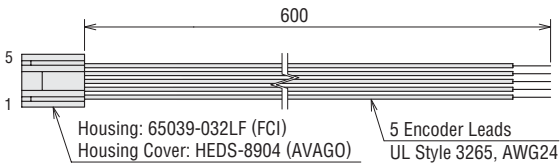

● Applicable Encoder Connector

Connector Model	Manufacturer
640442-5	Tyco Electronics AMP
HEDS-8903 (For 3-Channel: 5-lead wires)	Avago Technologies Limited
2695 Series (Housing)	Molex
2759 Series (Contact)	

Encoder Specifications

→ Page 72

Speed – Torque Characteristics

How to read speed – torque characteristics → Page 79

PK264-01A/PK264-01B PK264-01AR21-L/PK264-01AR22-L Bipolar (series)

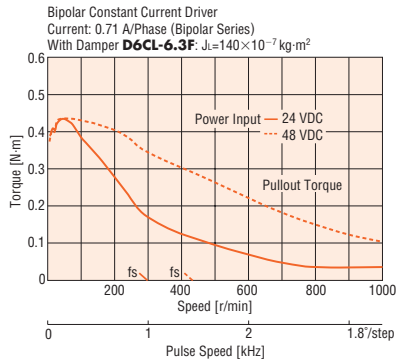

PK264-01A/PK264-01B PK264-01AR21-L/PK264-01AR22-L Unipolar

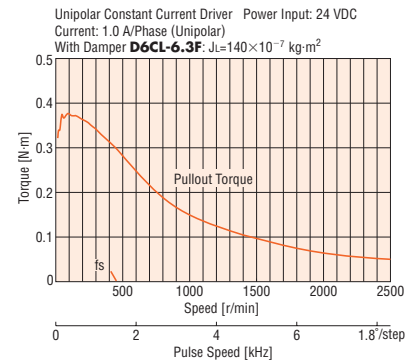

PK264-02A/PK264-02B/PK264E-2.0A/PK264E-2.0B PK264-02AR21-L/PK264-02AR22-L PK264EAR21-L/PK264EAR22-L Bipolar (Series)

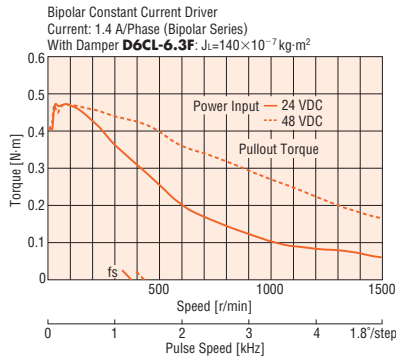

PK264-02A/PK264-02B/PK264-E2.0A/PK264-E2.0B PK264-02AR21-L/PK264-02AR22-L PK264EAR21-L/PK264EAR22-L Unipolar

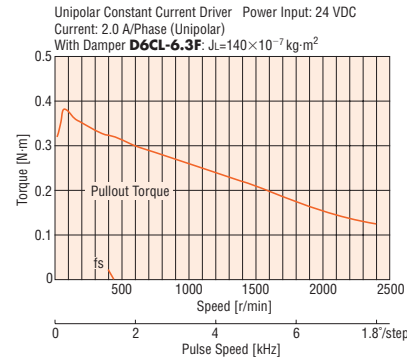

PK264-03A/PK264-03B PK264-03AR21-L/PK264-03AR22-L Bipolar (Series)

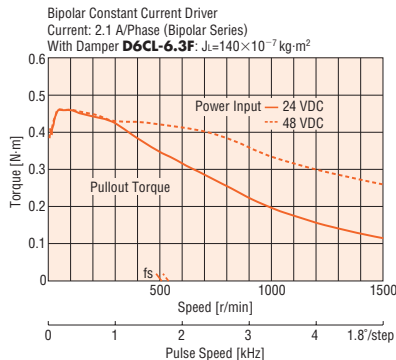

PK264-03A/PK264-03B PK264-03AR21-L/PK264-03AR22-L Unipolar

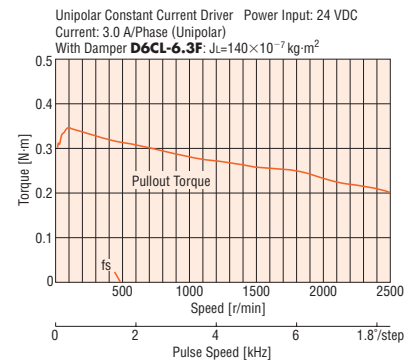

PK264E-2.0A/PK264E-2.0B PK264EAR21-L/PK264EAR22-L Bipolar (Parallel)

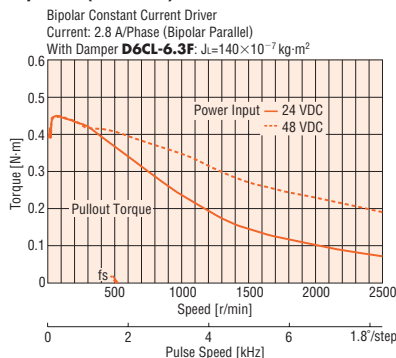

PK264DA/PK264DB Bipolar

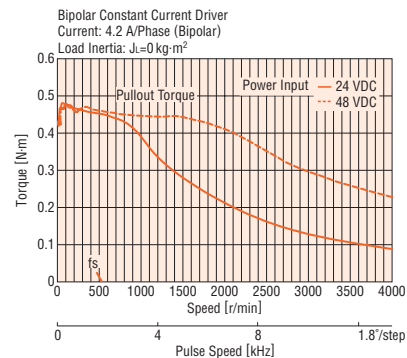

Note:

● Pay attention to heat dissipation from motor as there will be a considerable amount of heat under certain conditions. Be sure to keep the temperature of the motor case under 100°C.

High-Efficiency	28 mm
High-Torque	35 mm
Standard	42 mm
IP54 Cable Type	50 mm
Terminal Box	56.4 mm
High-Resolution	60 mm
PL Geared	85 mm
TH Geared	90 mm
SH Geared	90 mm
2-Phase	Motor & Driver Package
5-Phase	Motor & Driver Package
Lead Wire/Connector	Accessories
Coupling	
Damper	
Mounting Bracket	

Speed – Torque Characteristics

How to read speed – torque characteristics → Page 79

PK266-01A/PK266-01B PK266-01AR21-L/PK266-01AR22-L Bipolar (Series)

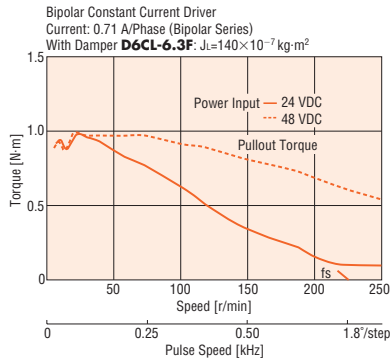

PK266-01A/PK266-01B PK266-01AR21-L/PK266-01AR22-L Unipolar

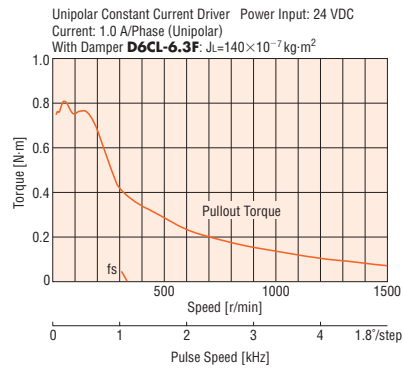

PK266-02A/PK266-02B/PK266E-2.0A/PK266E-2.0B PK266-02AR21-L/PK266-02AR22-L PK266EAR21-L/PK266EAR22-L Bipolar (Series)

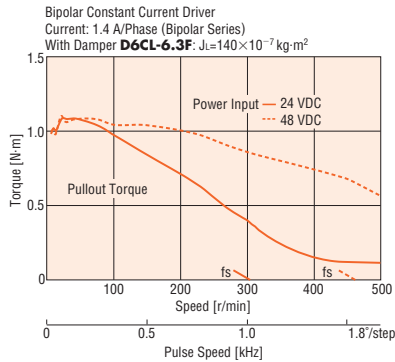

PK266-02A/PK266-02B/PK266E-2.0A/PK266E-2.0B PK266-02AR21-L/PK266-02AR22-L PK266EAR21-L/PK266EAR22-L Unipolar

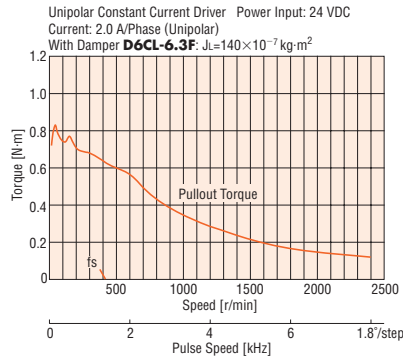

PK266-03A/PK266-03B PK266-03AR21-L/PK266-03AR22-L Bipolar (Series)

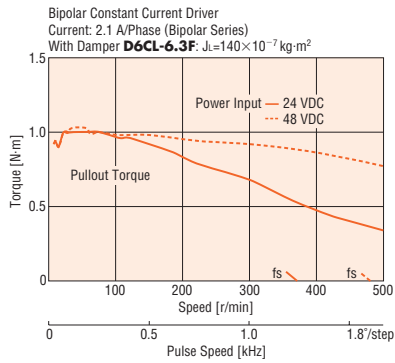

PK266-03A/PK266-03B PK266-03AR21-L/PK266-03AR22-L Unipolar

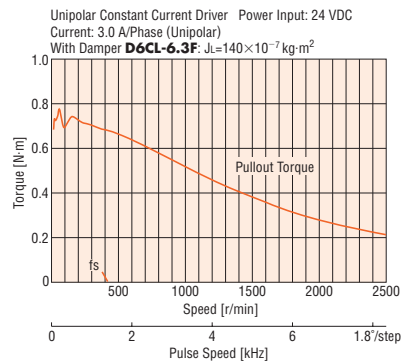

PK266E-2.0A/PK266E-2.0B PK266EAR21-L/PK266EAR22-L Bipolar (Parallel)

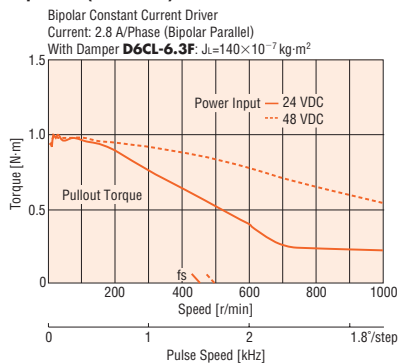

PK266DA/PK266DB Bipolar

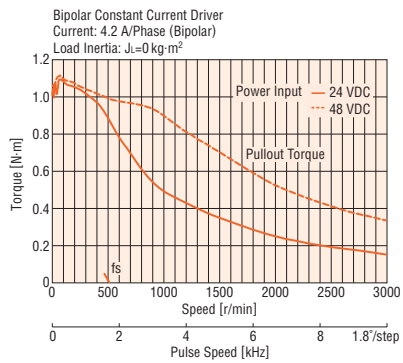

Note:

● Pay attention to heat dissipation from motor as there will be a considerable amount of heat under certain conditions. Be sure to keep the temperature of the motor case under 100°C.

PK268-01A/PK268-01B
PK268-01AR21-L/PK268-01AR22-L
 Bipolar (Series)

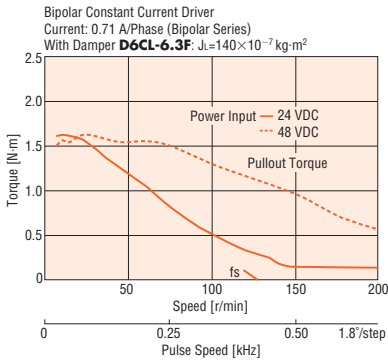

PK268-02A/PK268-02B/PK268E-2.0A/PK268E-2.0B
PK268-02AR21-L/PK268-02AR22-L
PK268EAR21-L/PK268EAR22-L
 Bipolar (Series)

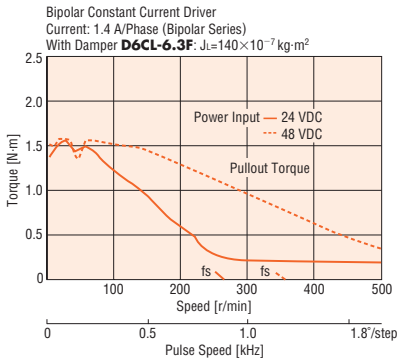

PK268-03A/PK268-03B
PK268-03AR21-L/PK268-03AR22-L
 Bipolar (Series)

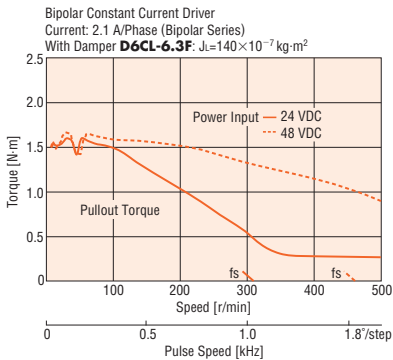

PK268E-2.0A/PK268E-2.0B
PK268EAR21-L/PK268EAR22-L
 Bipolar (Parallel)

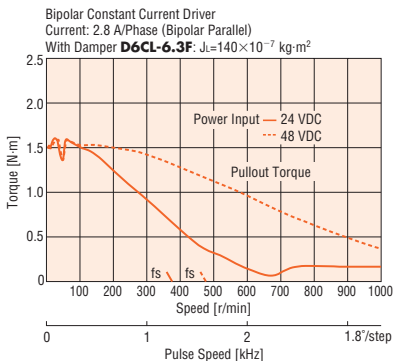

PK268-01A/PK268-01B
PK268-01AR21-L/PK268-01AR22-L
 Unipolar

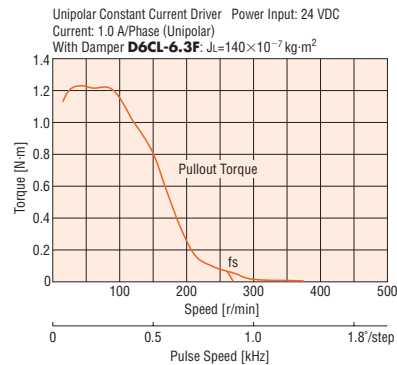

PK268-02A/PK268-02B/PK268E-2.0A/PK268E-2.0B
PK268-02AR21-L/PK268-02AR22-L
PK268EAR21-L/PK268EAR22-L
 Unipolar

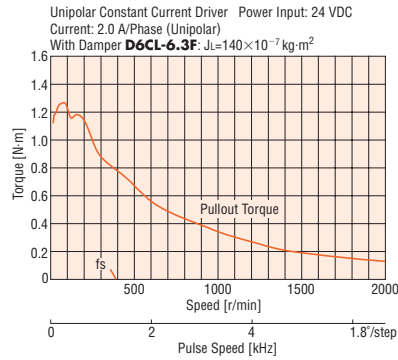

PK268-03A/PK268-03B
PK268-03AR21-L/PK268-03AR22-L
 Unipolar

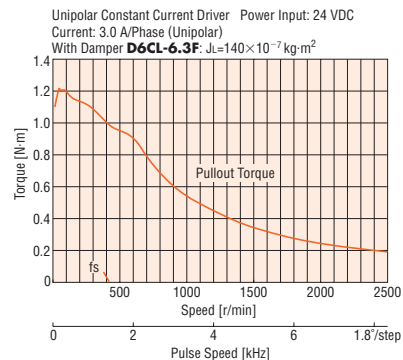

PK268DA/PK268DB
 Bipolar

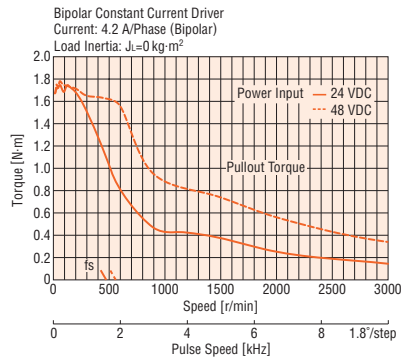

Note:

● Pay attention to heat dissipation from motor as there will be a considerable amount of heat under certain conditions. Be sure to keep the temperature of the motor case under 100°C.

High-Efficiency	<input type="checkbox"/> 28 mm
High-Torque	<input type="checkbox"/> 35 mm
Standard	<input type="checkbox"/> 42 mm
IP54 Cable Type	<input type="checkbox"/> 50 mm
Terminal Box	<input type="checkbox"/> 56.4 mm
High-Resolution	<input type="checkbox"/> 60 mm
PL Geared	<input type="checkbox"/> 85 mm
TH Geared	<input type="checkbox"/> 90 mm
SH Geared	<input type="checkbox"/> 90 mm
2-Phase	Motor & Driver Package
5-Phase	Motor & Driver Package
Lead Wire/Connector	Accessories
Coupling	
Damper	
Mounting Bracket	

56.4 mm

Step Angle 1.8°
Standard Type IP54 Rated Motor with Cable

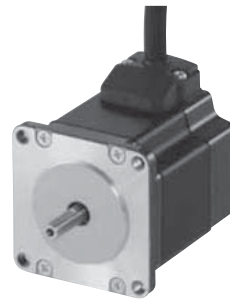

Specifications RoHS



Model Single Shaft	Connection Type	Holding Torque N·m	Current per Phase A/phase	Voltage V	Resistance per Phase Ω/phase	Inductance mH/phase	Rotor Inertia J: kg·m ²	Lead Wires	Wirings and Connections (See Page 76)
PK264DW	Bipolar	0.48	4.2	1.26	0.3	0.6	120×10 ⁻⁷	4	1
PK266DW	Bipolar	1.17	4.2	1.68	0.4	1.1	300×10 ⁻⁷	4	1
PK268DW	Bipolar	1.75	4.2	2.1	0.5	1.6	480×10 ⁻⁷	4	1

How to read specifications table → Page 78

Detail of safety standards → Page 73

- Degree of Protection: IP54 (Excluding the motor mounting surface)
- For the information of the applicable driver, please contact the nearest Oriental Motor sales office.

Dimensions (Unit = mm)

Model	L	Mass kg
PK264DW	47	0.55
PK266DW	62	0.8
PK268DW	84	1.15

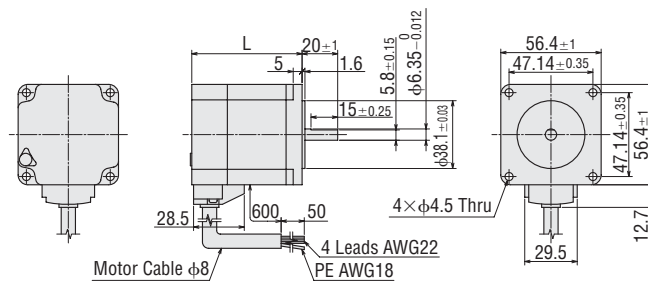

Speed – Torque Characteristics

How to read speed – torque characteristics → Page 79

PK264DW

Bipolar

Bipolar Constant Current Driver
Current: 4.2 A/Phase (Bipolar)
Load Inertia: $J_L=0 \text{ kg}\cdot\text{m}^2$

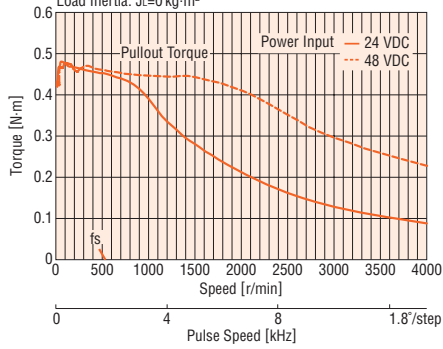

PK266DW

Bipolar

Bipolar Constant Current Driver
Current: 4.2 A/Phase (Bipolar)
Load Inertia: $J_L=0 \text{ kg}\cdot\text{m}^2$

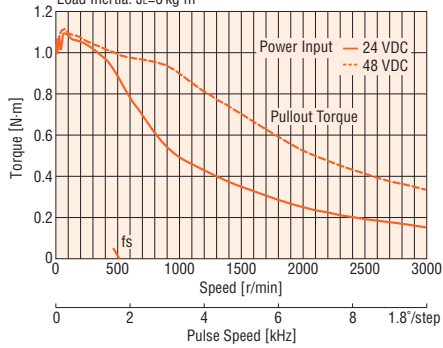

PK268DW

Bipolar

Bipolar Constant Current Driver
Current: 4.2 A/Phase (Bipolar)
Load Inertia: $J_L=0 \text{ kg}\cdot\text{m}^2$

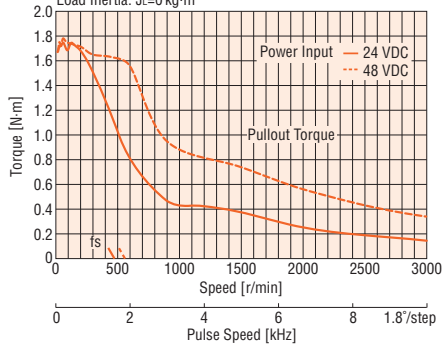

Note:

● Pay attention to heat dissipation from motor as there will be a considerable amount of heat under certain conditions. Be sure to keep the temperature of the motor case under 100°C.

High-Efficiency	28 mm	High-Torque	35 mm	Standard	42 mm	Cable Type	IP54	Terminal Box	IP65	High-Resolution	56.4 mm	PL Geared	60 mm	TH Geared	85 mm	SH Geared	90 mm	Motor & Driver Packages	2-Phase	5-Phase	Accessories	

56.4 mm

Step Angle 1.8°

Standard Type IP65 Rated Motor with Terminal Box



Specifications RoHS



Model Single Shaft	Connection Type	Holding Torque N·m	Current per Phase A/phase	Voltage V	Resistance per Phase Ω/phase	Inductance mH/phase	Rotor Inertia J: kg·m ²	Lead Wires (Terminals)	Wirings and Connections (See Page 76)	Corresponding Motor & Driver Package	
										Model	Page
PK264DAT	Bipolar	0.48	2.8	1.96	0.7	1.4	120×10 ⁻⁷	4	[7]	—	
PK264D1T	Bipolar	0.48	4.2	1.26	0.3	0.6	120×10 ⁻⁷	4	[7]	RBK264T	P.80
PK266DAT	Bipolar	1.17	2.8	2.52	0.9	2.5	300×10 ⁻⁷	4	[7]	—	
PK266D1T	Bipolar	1.17	4.2	1.68	0.4	1.1	300×10 ⁻⁷	4	[7]	RBK266T	P.80
PK268DAT	Bipolar	1.75	2.8	3.16	1.13	3.6	480×10 ⁻⁷	4	[7]	—	
PK268D1T	Bipolar	1.75	4.2	2.1	0.5	1.6	480×10 ⁻⁷	4	[7]	RBK268T	P.80

How to read specifications table → Page 78

Detail of safety standards → Page 73

● Degree of Protection: IP65 (Excluding the gap between the shaft and the flange)

Dimensions (Unit = mm)

Model	L	Mass kg
PK264DAT PK264D1T	83	0.6
PK266DAT PK266D1T	98	0.9
PK268DAT PK268D1T	120	1.2

● Use cable (VCT) with a diameter of $\phi 7 \sim \phi 13$ mm. Accessory motor cable (with protective earth wire, sold separately) is available. → Page 90

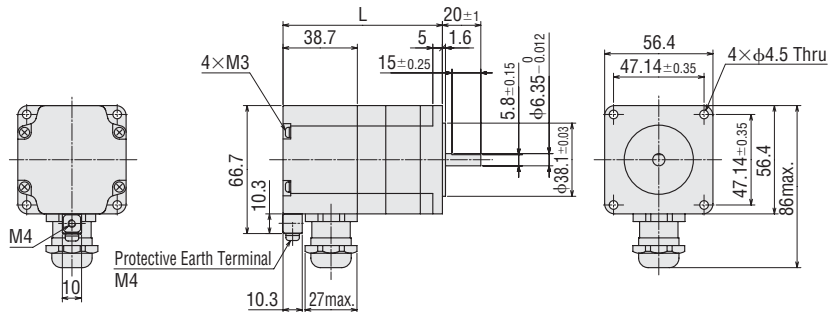

Speed – Torque Characteristics

How to read speed – torque characteristics → Page 79

PK264DAT

Bipolar

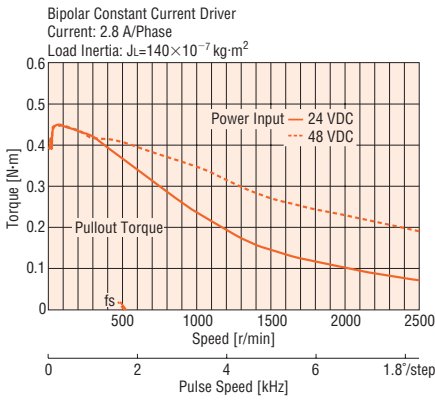

PK264D1T

Bipolar

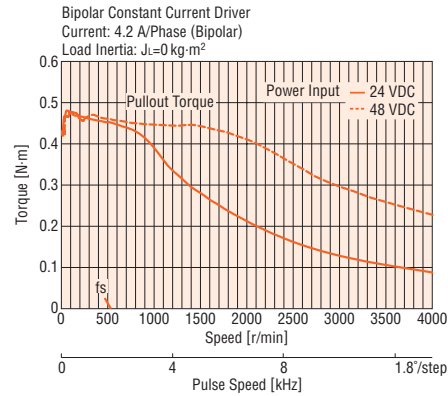

PK266DAT

Bipolar

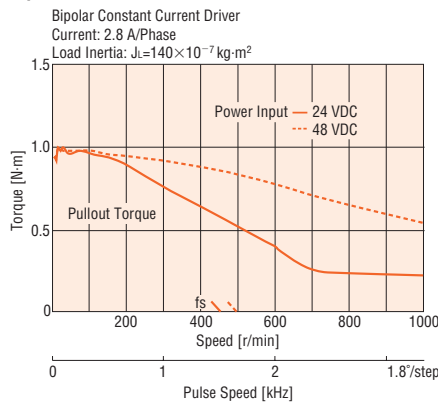

PK266D1T

Bipolar

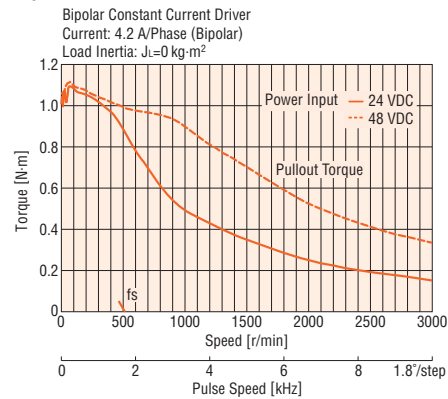

PK268DAT

Bipolar

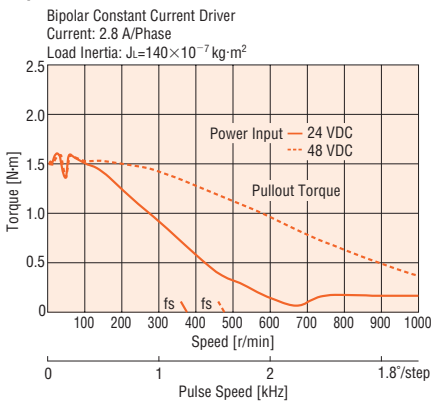

PK268D1T

Bipolar

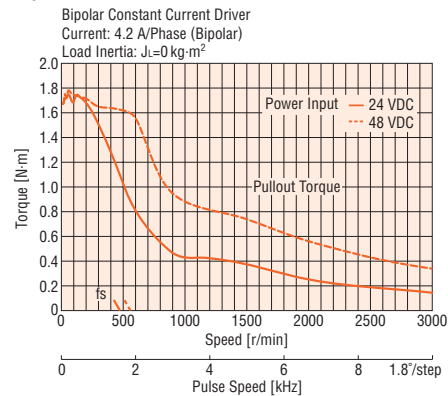

Note:

● Pay attention to heat dissipation from motor as there will be a considerable amount of heat under certain conditions. Be sure to keep the temperature of the motor case under 100°C.

High-Efficiency	28 mm
High-Torque	35 mm
Standard	42 mm
Cable Type	IP54
Terminal Box	IP65
High-Resolution	56.4 mm
PL Geared	60 mm
TH Geared	85 mm
SH Geared	90 mm
2-Phase	Motor & Driver Package
5-Phase	
Lead Wire/Connector	Accessories
Coupling	
Damper	
Mounting Bracket	

56.4 mm

Step Angle 0.9°
High-Resolution Type

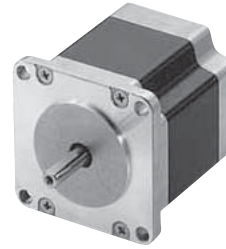

Specifications RoHS

Model Single Shaft Double Shaft	Connection Type	Holding Torque N·m	Current per Phase A/phase	Voltage V	Resistance per Phase Ω/phase	Inductance mH/phase	Rotor Inertia J: kg·m ²	Lead Wires	Wirings and Connections (See Page 76)	Corresponding Motor & Driver Package	
										Model	Page
PK264M-01A	Bipolar (Series)	0.48	0.71	8.1	11.4	26	120×10 ⁻⁷	6	[3]	-	-
PK264M-01B	Unipolar	0.39	1	5.7	5.7	6.5			[2]		
PK264M-02A	Bipolar (Series)	0.48	1.4	3.9	2.8	6.8	120×10 ⁻⁷	6	[3]	-	-
PK264M-02B	Unipolar	0.39	2	2.8	1.4	1.7			[2]		
PK264M-03A	Bipolar (Series)	0.48	2.1	2.6	1.26	3	120×10 ⁻⁷	6	[3]	-	-
PK264M-03B	Unipolar	0.39	3	1.9	0.63	0.75			[2]		
PK264M-E2.0A	Bipolar (Parallel)	0.48	2.8	1.96	0.7	1.7	120×10 ⁻⁷	8	[6]	-	-
PK264M-E2.0B	Bipolar (Series)	0.48	1.4	3.9	2.8	6.8			[5]		
	Unipolar	0.39	2	2.8	1.4	1.7			[4]		
PK266M-01A	Bipolar (Series)	1.17	0.71	11	14.8	50.8	300×10 ⁻⁷	6	[3]	-	-
PK266M-01B	Unipolar	0.9	1	7.4	7.4	12.7			[2]		
PK266M-02A	Bipolar (Series)	1.17	1.4	5	3.6	12.8	300×10 ⁻⁷	6	[3]	-	-
PK266M-02B	Unipolar	0.9	2	3.6	1.8	3.2			[2]		
PK266M-03A	Bipolar (Series)	1.17	2.1	3.2	1.5	5.8	300×10 ⁻⁷	6	[3]	-	-
PK266M-03B	Unipolar	0.9	3	2.3	0.75	1.45			[2]		
PK266M-E2.0A	Bipolar (Parallel)	1.17	2.8	2.52	0.9	3.2	300×10 ⁻⁷	8	[6]	-	-
PK266M-E2.0B	Bipolar (Series)	1.17	1.4	5	3.6	12.8			[5]		
	Unipolar	0.9	2	3.6	1.8	3.2			[4]		
PK268M-01A	Bipolar (Series)	1.75	0.71	12	17.2	77.6	480×10 ⁻⁷	6	[3]	-	-
PK268M-01B	Unipolar	1.35	1	8.6	8.6	19.4			[2]		
PK268M-02A	Bipolar (Series)	1.75	1.4	6.3	4.5	19.2	480×10 ⁻⁷	6	[3]	-	-
PK268M-02B	Unipolar	1.35	2	4.5	2.25	4.8			[2]		
PK268M-03A	Bipolar (Series)	1.75	2.1	4.2	2	8.4	480×10 ⁻⁷	6	[3]	-	-
PK268M-03B	Unipolar	1.35	3	3	1	2.1			[2]		
PK268M-E2.0A	Bipolar (Parallel)	1.75	2.8	3.16	1.13	4.8	480×10 ⁻⁷	8	[6]	-	-
PK268M-E2.0B	Bipolar (Series)	1.75	1.4	6.3	4.5	19.2			[5]		
	Unipolar	1.35	2	4.5	2.25	4.8			[4]		

How to read specifications table → Page 78

● Degree of Protection: IP30

Dimensions (Unit = mm)

Model	L1	L2	Mass kg
PK264M-0□A, PK264M-E2.0A	39	-	0.45
PK264M-0□B, PK264M-E2.0B		55	
PK266M-0□A, PK266M-E2.0A	54	-	0.7
PK266M-0□B, PK266M-E2.0B		70	
PK268M-0□A, PK268M-E2.0A	76	-	1.0
PK268M-0□B, PK268M-E2.0B		92	

● Enter the winding specifications in the box (□) within the model name.

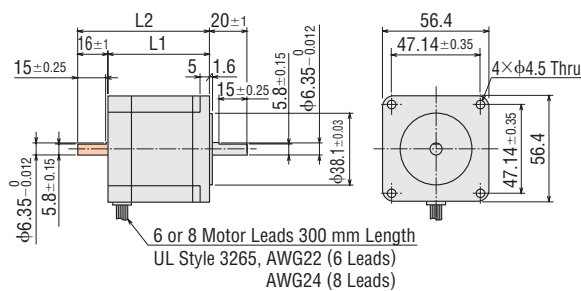

● These dimensions are for double shaft models. For single shaft models, ignore the orange (□) areas.

56.4 mm

Step Angle 0.9°
High-Resolution Type with Encoder



Specifications (RoHS)

Model Single Shaft	Connection Type	Holding Torque N·m	Current per Phase A/phase	Voltage V	Resistance per Phase Ω/phase	Inductance mH/phase	Rotor Inertia J: kg·m ²	Lead Wires	Wirings and Connections (See Page 76)
PK264M-01AR22-L* PK264M-01AR22	Bipolar (Series)	0.48	0.71	8.1	11.4	26	120×10 ⁻⁷	6	③
	Unipolar	0.39	1	5.7	5.7	6.5			②
PK264M-02AR22-L* PK264M-02AR22	Bipolar (Series)	0.48	1.4	3.9	2.8	6.8	120×10 ⁻⁷	6	③
	Unipolar	0.39	2	2.8	1.4	1.7			②
PK264M-03AR22-L* PK264M-03AR22	Bipolar (Series)	0.48	2.1	2.6	1.26	3	120×10 ⁻⁷	6	③
	Unipolar	0.39	3	1.9	0.63	0.75			②
PK264MEAR22-L* PK264MEAR22	Bipolar (Parallel)	0.48	2.8	1.96	0.7	1.7	120×10 ⁻⁷	8	⑥
	Bipolar (Series)	0.48	1.4	3.9	2.8	6.8			⑤
	Unipolar	0.39	2	2.8	1.4	1.7			④
PK266M-01AR22-L* PK266M-01AR22	Bipolar (Series)	1.17	0.71	11	14.8	50.8	300×10 ⁻⁷	6	③
	Unipolar	0.9	1	7.4	7.4	12.7			②
PK266M-02AR22-L* PK266M-02AR22	Bipolar (Series)	1.17	1.4	5	3.6	12.8	300×10 ⁻⁷	6	③
	Unipolar	0.9	2	3.6	1.8	3.2			②
PK266M-03AR22-L* PK266M-03AR22	Bipolar (Series)	1.17	2.1	3.2	1.5	5.8	300×10 ⁻⁷	6	③
	Unipolar	0.9	3	2.3	0.75	1.45			②
PK266MEAR22-L* PK266MEAR22	Bipolar (Parallel)	1.17	2.8	2.52	0.9	3.2	300×10 ⁻⁷	8	⑥
	Bipolar (Series)	1.17	1.4	5	3.6	12.8			⑤
	Unipolar	0.9	2	3.6	1.8	3.2			④
PK268M-01AR22-L* PK268M-01AR22	Bipolar (Series)	1.75	0.71	12	17.2	77.6	480×10 ⁻⁷	6	③
	Unipolar	1.35	1	8.6	8.6	19.4			②
PK268M-02AR22-L* PK268M-02AR22	Bipolar (Series)	1.75	1.4	6.3	4.5	19.2	480×10 ⁻⁷	6	③
	Unipolar	1.35	2	4.5	2.25	4.8			②
PK268M-03AR22-L* PK268M-03AR22	Bipolar (Series)	1.75	2.1	4.2	2	8.4	480×10 ⁻⁷	6	③
	Unipolar	1.35	3	3	1	2.1			②
PK268MEAR22-L* PK268MEAR22	Bipolar (Parallel)	1.75	2.8	3.16	1.13	4.8	480×10 ⁻⁷	8	⑥
	Bipolar (Series)	1.75	1.4	6.3	4.5	19.2			⑤
	Unipolar	1.35	2	4.5	2.25	4.8			④

How to read specifications table → Page 78

● Degree of Protection: IP30 (Excluding the encoder)

● "R22" in the model name indicates the encoder resolution.
R22: 400 pulses/revolution

* Encoder lead wire/connector assembly of 0.6 m is included with the product which have "-L" at the end of the model name.
Encoder lead wire/connector assembly is not included with the product that has no "-L" at the end of the model name.

Dimensions (Unit = mm)

Model	Motor Model	L1	L2	Mass kg
PK264M-0□AR22-L	PK264M-0□AR22	39	57.3	0.47
PK264MEAR22-L	PK264MEAR22			
PK266M-0□AR22-L	PK266M-0□AR22	54	72.3	0.72
PK266MEAR22-L	PK266MEAR22			
PK268M-0□AR22-L	PK268M-0□AR22	76	94.3	1.02
PK268MEAR22-L	PK268MEAR22			

● Enter the winding specifications in the box (□) within the model name.

● Applicable Encoder Connector

Connector Model	Manufacturer
640442-5	Tyco Electronics AMP
HEDS-8903 (For 3-Channel: 5-lead wires)	Avago Technologies Limited
2695 Series (Housing)	Molex
2759 Series (Contact)	

Encoder Specifications

→ Page 72

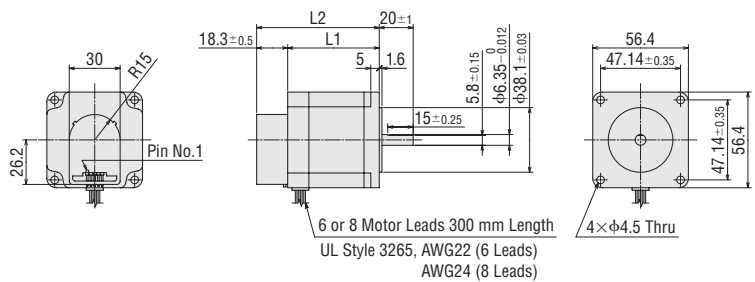

● Encoder Lead Wire/Connector Assembly (Included with the product which have "-L" at the end of the model name)

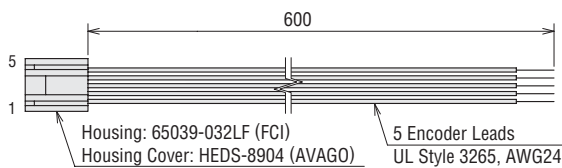

High-Efficiency	28 mm
High-Torque	35 mm
Standard	42 mm
Cable Type	IP54
Terminal Box	IP65
High-Resolution	56.4 mm
PL Geared	60 mm
TH Geared	85 mm
SH Geared	90 mm
2-Phase	Motor & Driver Package
5-Phase	Motor & Driver Package
Lead Wire/Connector	Accessories
Coupling	Accessories
Damper	Accessories
Mounting Bracket	Accessories

**PK264M-01A/PK264M-01B
PK264M-01AR22-L**

Bipolar (Series)

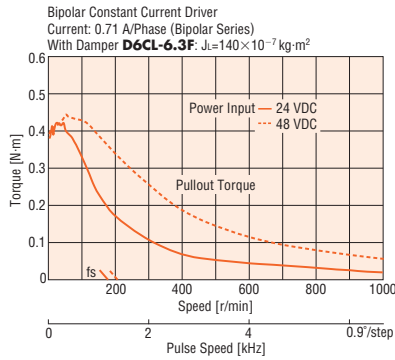

**PK264M-01A/PK264M-01B
PK264M-01AR22-L**

Unipolar

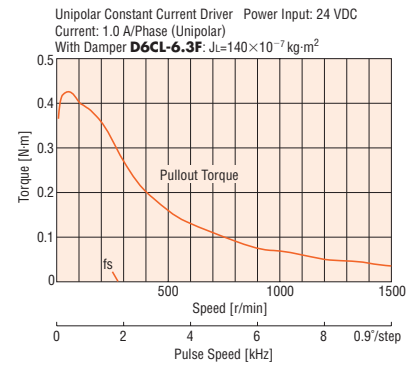

**PK264M-02A/PK264M-02B
PK264M-E2.0A/PK264M-E2.0B
PK264M-02AR22-L/PK264MEAR22-L**

Bipolar (Series)

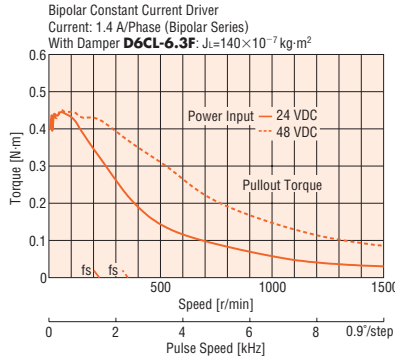

**PK264M-02A/PK264M-02B
PK264M-E2.0A/PK264M-E2.0B
PK264M-02AR22-L/PK264MEAR22-L**

Unipolar

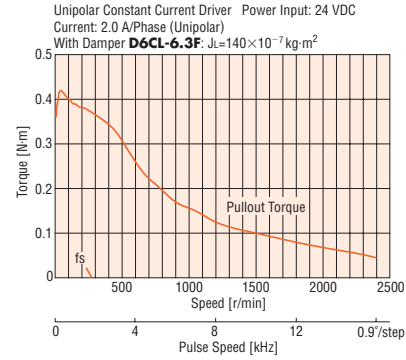

**PK264M-03A/PK264M-03B
PK264M-03AR22-L**

Bipolar (Series)

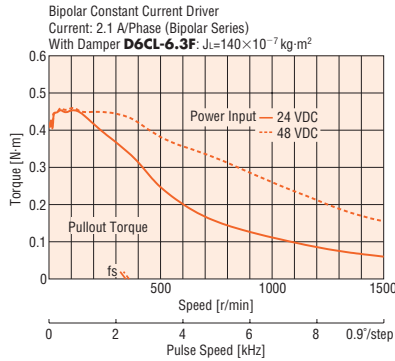

**PK264M-03A/PK264M-03B
PK264M-03AR22-L**

Unipolar

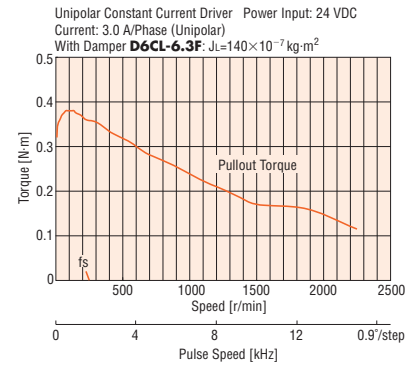

**PK264M-E2.0A/PK264M-E2.0B
PK264MEAR22-L**

Bipolar (Parallel)

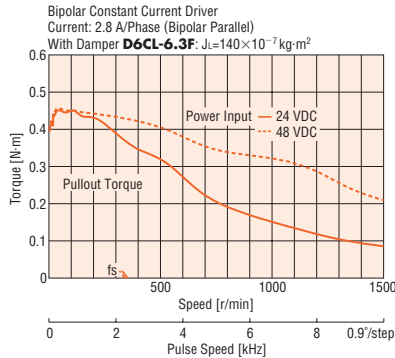

Note:

● Pay attention to heat dissipation from motor as there will be a considerable amount of heat under certain conditions. Be sure to keep the temperature of the motor case under 100°C.

PK266M-01A/PK266M-01B
PK266M-01AR22-L
 Bipolar (Series)

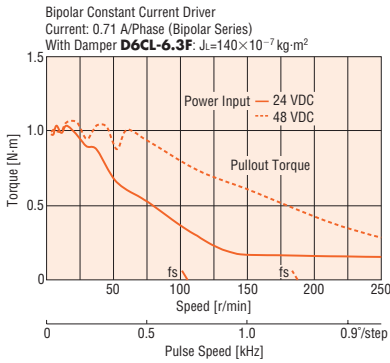

PK266M-02A/PK266M-02B
PK266M-E2.0A/PK266M-E2.0B
PK266M-02AR22-L/PK266MEAR22-L
 Bipolar (Series)

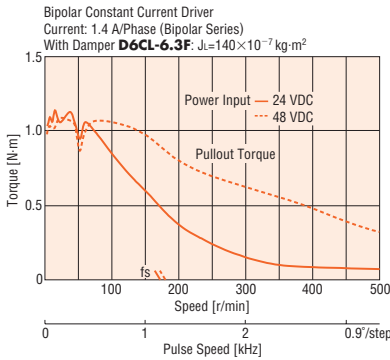

PK266M-03A/PK266M-03B
PK266M-03AR22-L
 Bipolar (Series)

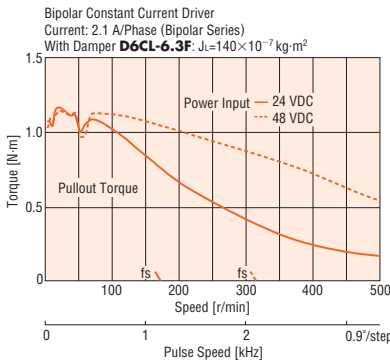

PK266M-E2.0A/PK266M-E2.0B
PK266MEAR22-L
 Bipolar (Parallel)

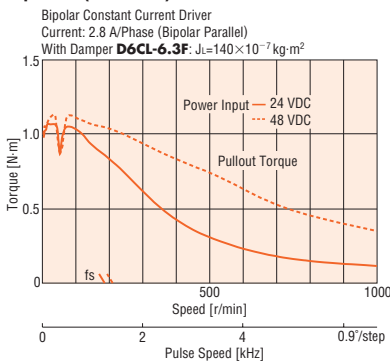

PK266M-01A/PK266M-01B
PK266M-01AR22-L
 Unipolar

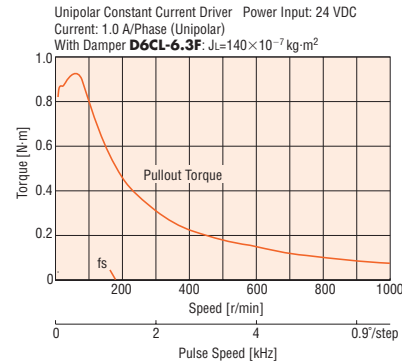

PK266M-02A/PK266M-02B
PK266M-E2.0A/PK266M-E2.0B
PK266M-02AR22-L/PK266MEAR22-L
 Unipolar

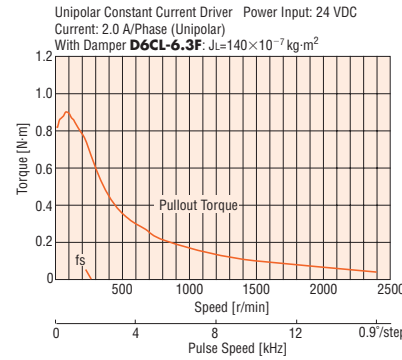

PK266M-03A/PK266M-03B
PK266M-03AR22-L
 Unipolar

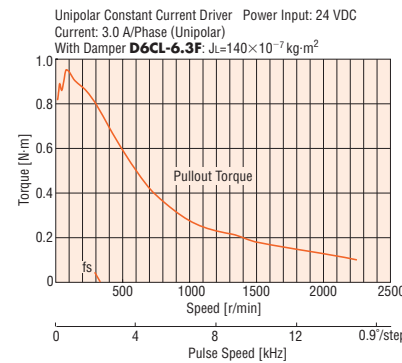

Note:

● Pay attention to heat dissipation from motor as there will be a considerable amount of heat under certain conditions. Be sure to keep the temperature of the motor case under 100°C.

High-Efficiency	<input type="checkbox"/> 28 mm
High-Torque	<input type="checkbox"/> 35 mm
Standard	<input type="checkbox"/> 42 mm
IP54 Cable Type	<input type="checkbox"/> 50 mm
IP65 Terminal Box	<input type="checkbox"/> 56.4 mm
High-Resolution	<input type="checkbox"/> 60 mm
PL Geared	<input type="checkbox"/> 85 mm
TH Geared	<input type="checkbox"/> 90 mm
SH Geared	<input type="checkbox"/> 90 mm
2-Phase	Motor & Driver Package
5-Phase	Motor & Driver Package
Lead Wire/Connector	Accessories
Coupling	
Damper	
Mounting Bracket	

**PK268M-01A/PK268M-01B
PK268M-01AR22-L**

Bipolar (Series)

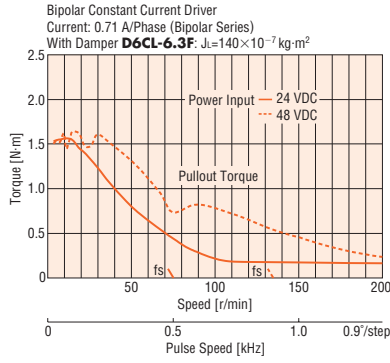

**PK268M-01A/PK268M-01B
PK268M-01AR22-L**

Unipolar

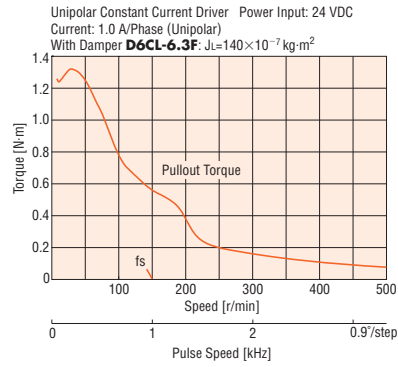

**PK268M-02A/PK268M-02B
PK268M-E2.0A/PK268M-E2.0B
PK268M-02AR22-L/PK268MEAR22-L**

Bipolar (Series)

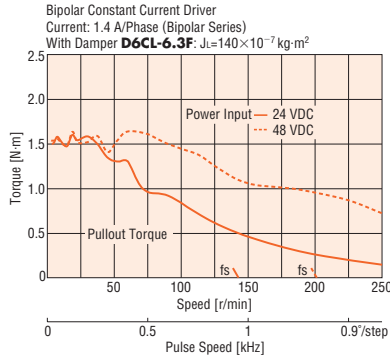

**PK268M-02A/PK268M-02B
PK268M-E2.0A/PK268M-E2.0B
PK268M-02AR22-L/PK268MEAR22-L**

Unipolar

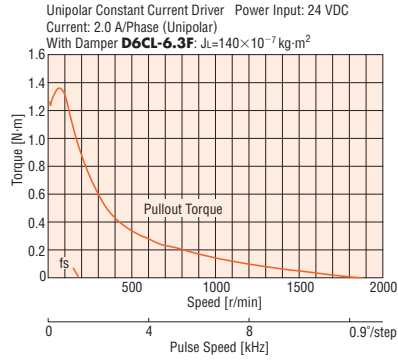

**PK268M-03A/PK268M-03B
PK268M-03AR22-L**

Bipolar (Series)

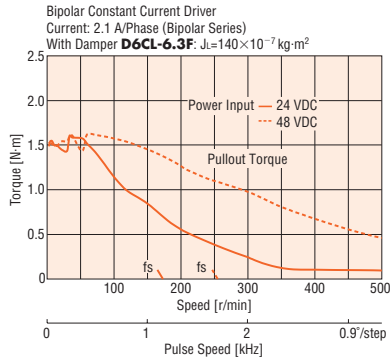

**PK268M-03A/PK268M-03B
PK268M-03AR22-L**

Unipolar

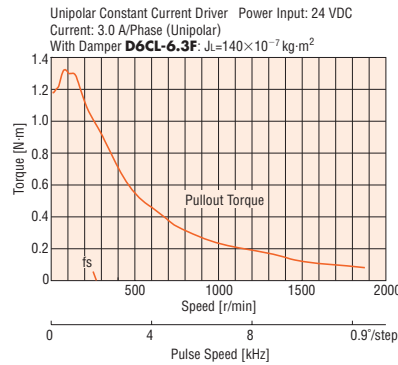

**PK268M-E2.0A/PK268M-E2.0B
PK268MEAR22-L**

Bipolar (Parallel)

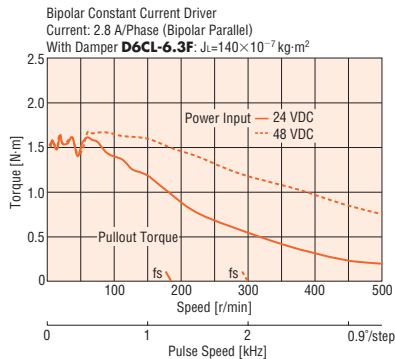

Note:

● Pay attention to heat dissipation from motor as there will be a considerable amount of heat under certain conditions. Be sure to keep the temperature of the motor case under 100°C.

60 mm

Step Angle 1.8°
High-Torque Type

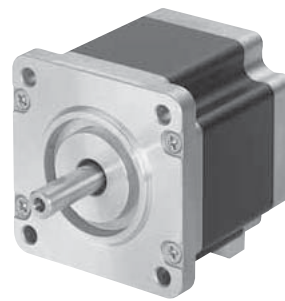

Specifications (RoHS)

Model Single Shaft Double Shaft	Connection Type	Holding Torque N·m	Current per Phase A/phase	Voltage V	Resistance per Phase Ω/phase	Inductance mH/phase	Rotor Inertia J: kg·m ²	Lead Wires	Wirings and Connections (See Page 76)
PK264JDA PK264JDB	Bipolar	1.06	2.8	2.1	0.73	1.8	280×10 ⁻⁷	4	①
PK264JA PK264JB	Bipolar (Series)	1.06	1.4	4.1	2.92	7.2	280×10 ⁻⁷	6	③
	Unipolar	0.75	2	2.9	1.46	1.8			②
PK266JDA PK266JDB	Bipolar	1.75	2.8	2.8	1	3.05	450×10 ⁻⁷	4	①
PK266JA PK266JB	Bipolar (Series)	1.75	1.4	5.6	4	12.2	450×10 ⁻⁷	6	③
	Unipolar	1.35	2	4	2	3.05			②
PK267JDA PK267JDB	Bipolar	2.2	2.8	3.4	1.2	3.54	570×10 ⁻⁷	4	①
PK267JA PK267JB	Bipolar (Series)	2.2	1.4	6.7	4.8	14.2	570×10 ⁻⁷	6	③
	Unipolar	1.7	2	4.8	2.4	3.54			②
PK269JDA PK269JDB	Bipolar	3.1	2.8	4.2	1.49	5.7	900×10 ⁻⁷	4	①
PK269JA PK269JB	Bipolar (Series)	3.1	1.4	8.3	5.96	22.8	900×10 ⁻⁷	6	③
	Unipolar	2.2	2	6	2.98	5.7			②

How to read specifications table → Page 78

● Degree of Protection: IP30

● For the information of the applicable driver, please contact the nearest Oriental Motor sales office.

Dimensions (Unit = mm)

Model	L1	L2	Mass kg
PK264JDA PK264JA	43.5	—	0.6
PK264JDB PK264JB		66.5	
PK266JDA PK266JA	54	—	0.83
PK266JDB PK266JB		77	
PK267JDA PK267JA	65	—	1.02
PK267JDB PK267JB		88	
PK269JDA PK269JA	85	—	1.43
PK269JDB PK269JB		108	

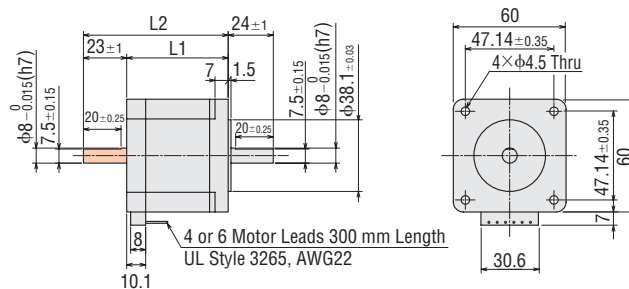

● These dimensions are for double shaft models. For single shaft models, ignore the orange (■) areas.

High-Efficiency	28 mm
High-Torque	35 mm
Standard	42 mm
Cable Type	50 mm
Terminal Box	56.4 mm
High-Resolution	60 mm
PL Geared	85 mm
TH Geared	90 mm
SH Geared	Motor & Driver Package
2-Phase	Motor & Driver Package
5-Phase	Motor & Driver Package
Lead Wire/Connector	Accessories
Coupling	Accessories
Damper	Accessories
Mounting Bracket	Accessories

PK264JDA/PK264JDB

Bipolar

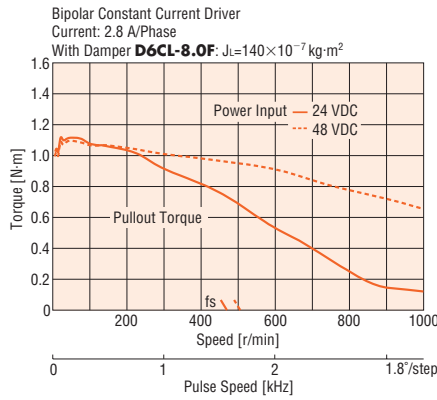

PK264JA/PK264JB

Bipolar (Series)

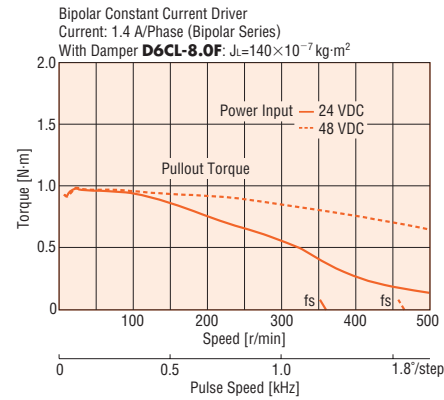

PK266JDA/PK266JDB

Bipolar

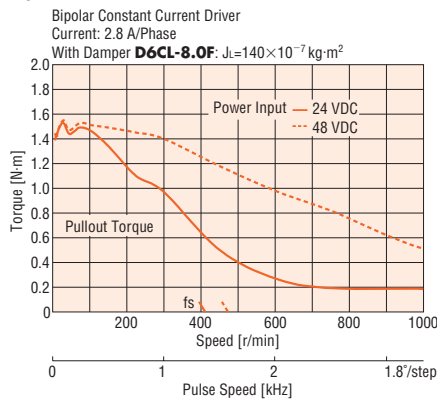

PK266JA/PK266JB

Bipolar (Series)

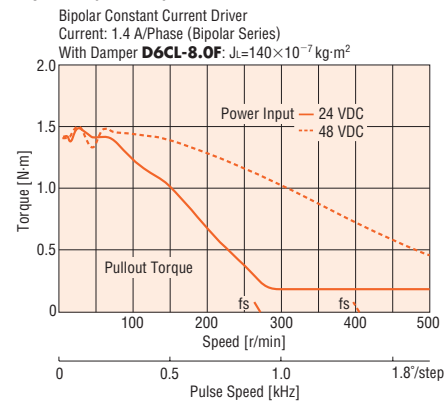

PK267JDA/PK267JDB

Bipolar

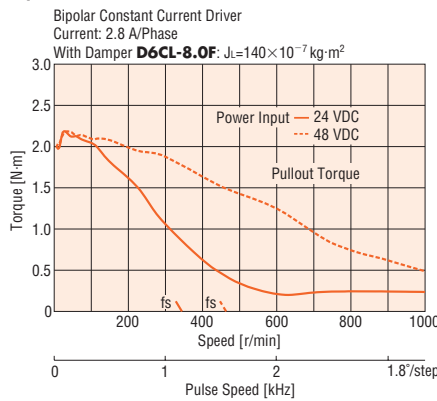

PK267JA/PK267JB

Bipolar (Series)

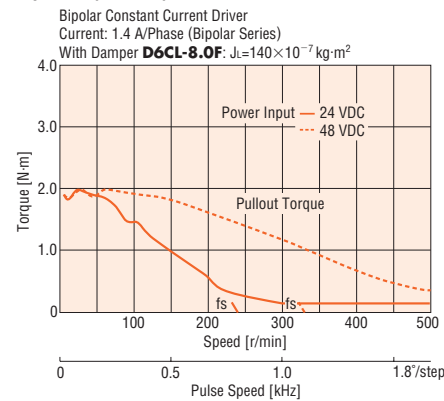

PK269JDA/PK269JDB

Bipolar

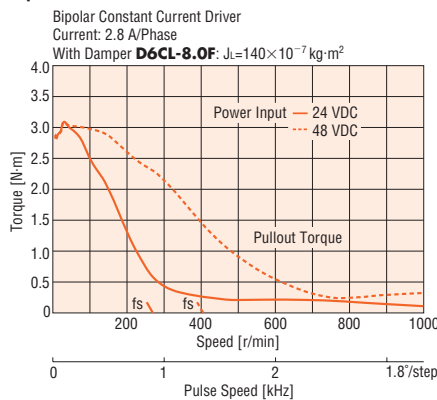

PK269JA/PK269JB

Bipolar (Series)

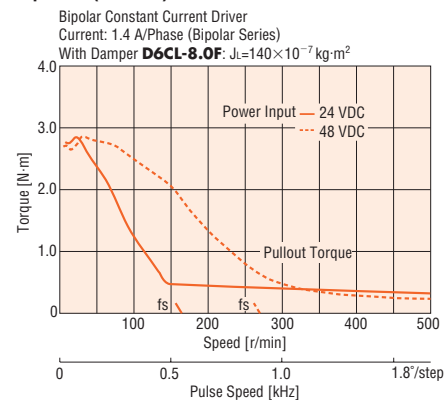

Note:

● Pay attention to heat dissipation from motor as there will be a considerable amount of heat under certain conditions. Be sure to keep the temperature of the motor case under 100°C.

PK264JA/PK264JB

Unipolar

Unipolar Constant Current Driver Power Input: 24 VDC
 Current: 2.0 A/Phase (Unipolar)
 With Damper **D6CL-8.0F**: $J_L=140 \times 10^{-7} \text{ kg}\cdot\text{m}^2$

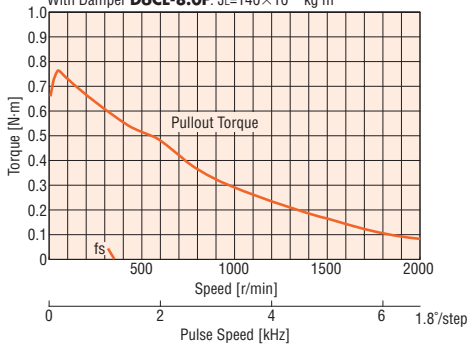

PK266JA/PK266JB

Unipolar

Unipolar Constant Current Driver Power Input: 24 VDC
 Current: 2.0 A/Phase (Unipolar)
 With Damper **D6CL-8.0F**: $J_L=140 \times 10^{-7} \text{ kg}\cdot\text{m}^2$

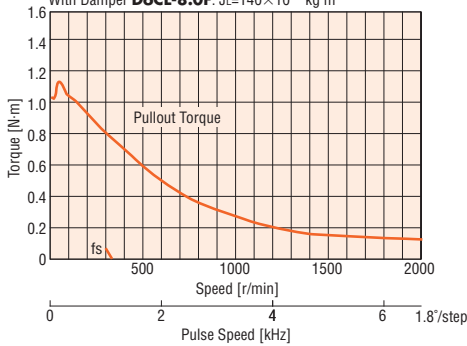

PK267JA/PK267JB

Unipolar

Unipolar Constant Current Driver Power Input: 24 VDC
 Current: 2.0 A/Phase (Unipolar)
 With Damper **D6CL-8.0F**: $J_L=140 \times 10^{-7} \text{ kg}\cdot\text{m}^2$

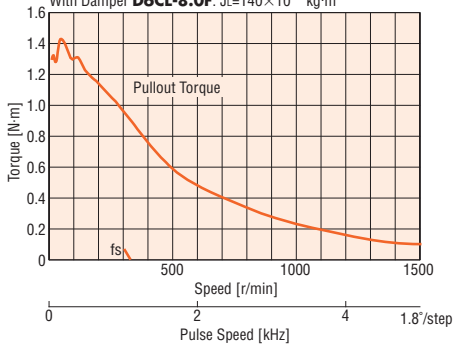

PK269JA/PK269JB

Unipolar

Unipolar Constant Current Driver Power Input: 24 VDC
 Current: 2.0 A/Phase (Unipolar)
 With Damper **D6CL-8.0F**: $J_L=140 \times 10^{-7} \text{ kg}\cdot\text{m}^2$

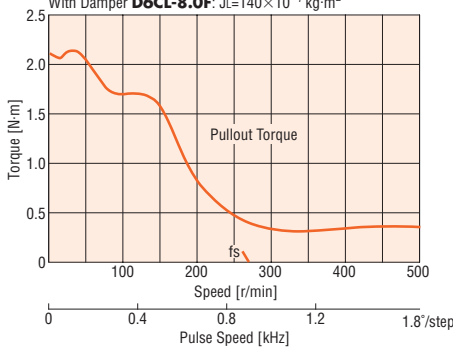

Note:

● Pay attention to heat dissipation from motor as there will be a considerable amount of heat under certain conditions. Be sure to keep the temperature of the motor case under 100°C.

High-Efficiency	<input type="checkbox"/> 28 mm
High-Torque	<input type="checkbox"/> 35 mm
Standard	<input type="checkbox"/> 42 mm
IP54 Cable Type	<input type="checkbox"/> 50 mm
IP55 Terminal Box	<input type="checkbox"/> 56.4 mm
High-Resolution	<input type="checkbox"/> 60 mm
PL Geared	<input type="checkbox"/> 85 mm
TH Geared	<input type="checkbox"/> 90 mm
SH Geared	<input type="checkbox"/> 90 mm
2-Phase	Motor & Driver Package
5-Phase	Motor & Driver Package
Lead Wire/Connector	Accessories
Coupling	
Damper	
Mounting Bracket	

60 mm

PL Geared Type

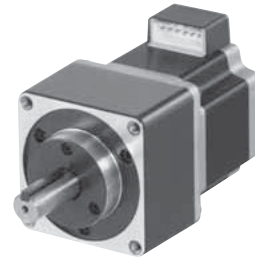

Specifications (RoHS)

Motor Specifications

Model Single Shaft Double Shaft	Connection Type	Current per Phase A/phase	Voltage V	Resistance per Phase Ω /phase	Inductance mH/phase	Rotor Inertia J: kg·m ²	Lead Wires (Pin)	Wirings and Connections (See Page 76)	Corresponding Motor & Driver Package	
									Model	Page
PK266PDA-P5-L* PK266PDA-P5 PK266PDB-P5-L* PK266PDB-P5	Bipolar	2.8	1.62	0.58	0.97	290×10^{-7}	4	1	RBK266PA-P5 RBK266PB-P5	P.80
PK266PDA-P10-L* PK266PDA-P10 PK266PDB-P10-L* PK266PDB-P10									RBK266PA-P10 RBK266PB-P10	P.80
PK264PDA-P36-L* PK264PDA-P36 PK264PDB-P36-L* PK264PDB-P36			RBK264PA-P36 RBK264PB-P36	P.80						
			1.29	0.46	0.73	120×10^{-7}				

How to read specifications table → Page 78

● Degree of Protection: IP30

* Motor lead wire/connector assembly of 0.6 m is included with the product which have “-L” at the end of the model name.
Motor lead wire/connector assembly is not included with the product that has no “-L” at the end of the model name.

Note:

● Direction of rotation of the motor and that of the gear output shaft are the same.

Gearmotor Specifications

Model Single Shaft Double Shaft	Gear Ratio	Holding Torque N·m	Step Angle	Backlash arc min (degrees)	Permissible Speed r/min
PK266PDA-P5-L, PK266PDA-P5 PK266PDB-P5-L, PK266PDB-P5	1:5	3.5	0.36°	20 (0.33)	360
PK266PDA-P10-L, PK266PDA-P10 PK266PDB-P10-L, PK266PDB-P10	1:10	5	0.18°	20 (0.33)	180
PK264PDA-P36-L, PK264PDA-P36 PK264PDB-P36-L, PK264PDB-P36	1:36	8	0.05°	20 (0.33)	50

Dimensions (Unit = mm)

Model	Motor Model	Gear Ratio	L1	L2	Mass kg
PK266PDA-P□-L PK266PDA-P□	PK266PDA-P□	1:5	89	112	1.23
PK266PDB-P□-L PK266PDB-P□	PK266PDB-P□	1:10			
PK264PDA-P36-L PK264PDA-P36	PK264PDA-P36	1:36	99	122	1.26
PK264PDB-P36-L PK264PDB-P36	PK264PDB-P36				

● Enter the gear ratio in the box (□) within the model name.

● Applicable Connector
Connector Housing: 51067-0600 (Molex)
Contact: 50217-9101 (Molex)
Crimp Tool: 57189-5000 (Molex)
57190-5000 (Molex)

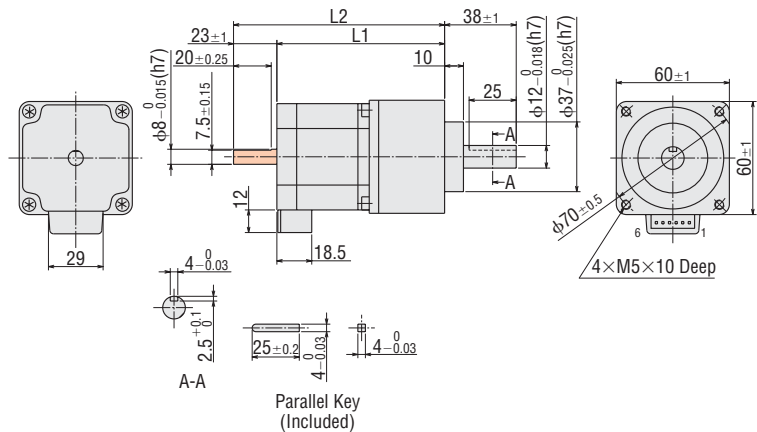

● These dimensions are for double shaft models. For single shaft models, ignore the orange (■) areas.

● Motor Lead Wire/Connector Assembly (Included with the product which have “-L” at the end of the model name): **LC2B06C**

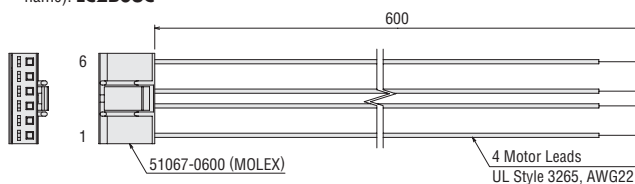

Speed – Torque Characteristics

How to read speed – torque characteristics → Page 79

PK266PDA-P□-L/PK266PDB-P□-L PK264PDA-P36-L/PK264PDB-P36-L

Bipolar 24 VDC

Bipolar Constant Current Driver Power Input: 24 VDC
Current: 2.8 A/Phase (Bipolar)
Load Inertia: $J_L=0 \text{ kg}\cdot\text{m}^2$

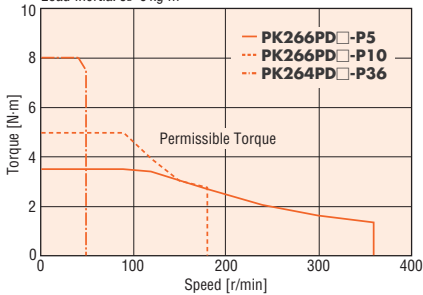

PK266PDA-P□-L/PK266PDB-P□-L PK264PDA-P36-L/PK264PDB-P36-L

Bipolar 36 VDC

Bipolar Constant Current Driver Power Input: 36 VDC
Current: 2.8 A/Phase (Bipolar)
Load Inertia: $J_L=0 \text{ kg}\cdot\text{m}^2$

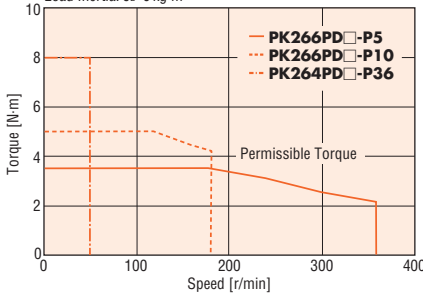

Note:

- Pay attention to heat dissipation from motor as there will be a considerable amount of heat under certain conditions. Be sure to keep the temperature of the motor case under 100°C.

Accessories (Sold separately)

If you select a product without motor lead wire/connector assembly (motor alone), applicable connector and lead wires must be furnished separately. They are available as an option.

- Motor Lead Wire/Connector Assembly → Page 90

High-Efficiency	28 mm	High-Torque	35 mm	Standard	42 mm	IP54 Cable Type	50 mm	IP65 Terminal Box	56.4 mm	High-Resolution	60 mm	PI Geared	85 mm	TH Geared	90 mm	Motor & Driver Package	2-Phase	5-Phase	Lead Wire/Connector	Coupling	Damper	Mounting Bracket
-----------------	-------	-------------	-------	----------	-------	-----------------	-------	-------------------	---------	-----------------	-------	-----------	-------	-----------	-------	------------------------	---------	---------	---------------------	----------	--------	------------------

60 mm

TH Geared Type



Specifications RoHS

Motor Specifications

Model Single Shaft Double Shaft	Connection Type	Current per Phase A/phase	Voltage V	Resistance per Phase Ω /phase	Inductance mH/phase	Rotor Inertia J: kg·m ²	Lead Wires	Wiring and Connections (See Page 76)	Corresponding Motor & Driver Package	
									Model	Page
PK264DA-T <input type="checkbox"/> PK264DB-T <input type="checkbox"/>	Bipolar	4.2	1.26	0.3	0.6	120×10^{-7}	4	[1]	–	–
PK264A2-T <input type="checkbox"/> PK264B2-T <input type="checkbox"/>	Bipolar (Series)	1.4	3.9	2.8	5.6	120×10^{-7}	6	[3]	–	–
	Unipolar	2	2.8	1.4	1.4			[2]	CMK264AP-T <input type="checkbox"/> CMK264BP-T <input type="checkbox"/>	P.82

How to read specifications table → Page 78

- Degree of Protection: IP30
- Enter the gear ratio in the box () within the model name.

Note:

- Direction of rotation of the motor and that of the gear output shaft are the same for the gear ratios 1:3.6, 1:7.2 and 1:10. It is the opposite for 1:20 and 1:30 gear ratios.

Gearmotor Specifications

Model Single Shaft Double Shaft	Gear Ratio	Holding Torque N·m	Step Angle	Backlash arc min (degrees)	Permissible Speed r/min
PK264DA-T3.6 , PK264A2-T3.6 PK264DB-T3.6 , PK264B2-T3.6	1:3.6	1.25	0.5°	35 (0.584°)	500
PK264DA-T7.2 , PK264A2-T7.2 PK264DB-T7.2 , PK264B2-T7.2	1:7.2	2.5	0.25°	15 (0.25°)	250
PK264DA-T10 , PK264A2-T10 PK264DB-T10 , PK264B2-T10	1:10	3	0.18°	15 (0.25°)	180
PK264DA-T20 , PK264A2-T20 PK264DB-T20 , PK264B2-T20	1:20	3.5	0.09°	10 (0.167°)	90
PK264DA-T30 , PK264A2-T30 PK264DB-T30 , PK264B2-T30	1:30	4	0.06°	10 (0.167°)	60

- Holding torque is the same regardless of the connection type, due to the permissible torque limit of the gearhead.

Dimensions (Unit = mm)

Model	Mass kg
PK264DA-T <input type="checkbox"/> PK264A2-T <input type="checkbox"/>	0.85
PK264DB-T <input type="checkbox"/> PK264B2-T <input type="checkbox"/>	

- Enter the gear ratio in the box () within the model name.

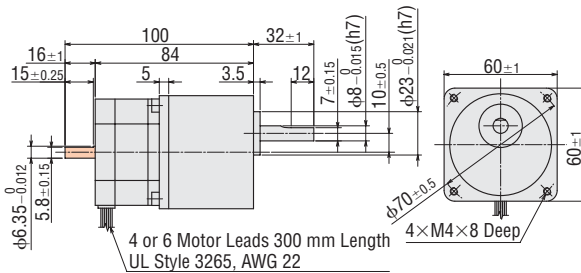

- These dimensions are for double shaft models. For single shaft models, ignore the orange () areas.

Speed – Torque Characteristics

How to read speed – torque characteristics → Page 79

PK264DA-T□/PK264DB-T□

Bipolar 24 VDC

Bipolar Constant Current Driver Power Input: 24 VDC
Current: 4.2 A/Phase (Bipolar)
Load Inertia: $J_L=0 \text{ kg}\cdot\text{m}^2$

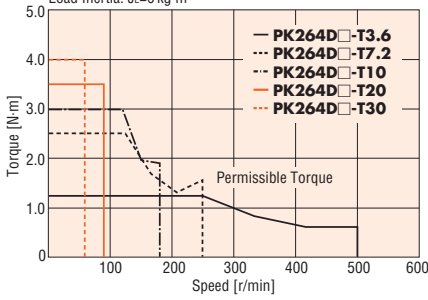

PK264DA-T□/PK264DB-T□

Bipolar 48 VDC

Bipolar Constant Current Driver Power Input: 48 VDC
Current: 4.2 A/Phase (Bipolar)
Load Inertia: $J_L=0 \text{ kg}\cdot\text{m}^2$

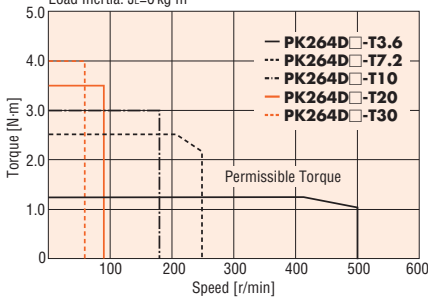

PK264A2-T□/PK264B2-T□

Bipolar (Series) 24 VDC

Bipolar Constant Current Driver Power Input: 24 VDC
Current: 1.4 A/Phase (Bipolar Series)
Load Inertia: $J_L=0 \text{ kg}\cdot\text{m}^2$

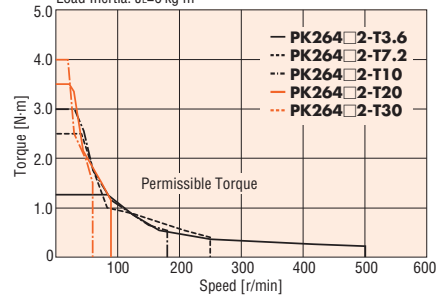

PK264A2-T□/PK264B2-T□

Bipolar (Series) 48 VDC

Bipolar Constant Current Driver Power Input: 48 VDC
Current: 1.4 A/Phase (Bipolar Series)
Load Inertia: $J_L=0 \text{ kg}\cdot\text{m}^2$

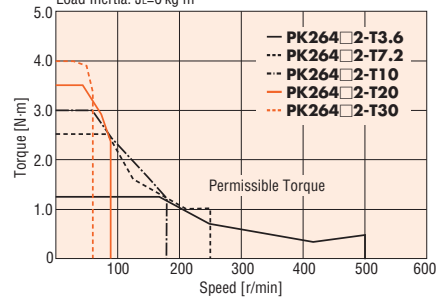

PK264A2-T□/PK264B2-T□

Unipolar 24 VDC

Unipolar Constant Current Driver Power Input: 24 VDC
Current: 2.0 A/Phase (Unipolar)
With Damper **D6CL-6.3F**: $J_L=140 \times 10^{-7} \text{ kg}\cdot\text{m}^2$

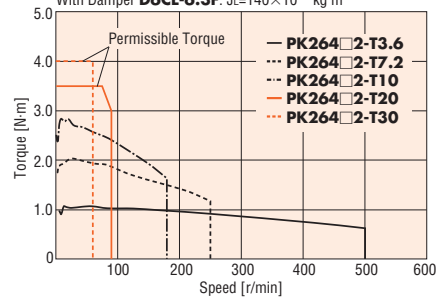

Note:

● Pay attention to heat dissipation from motor as there will be a considerable amount of heat under certain conditions. Be sure to keep the temperature of the motor case under 100°C.

High-Efficiency	□ 28 mm
High-Torque	□ 35 mm
Standard	□ 42 mm
Cable Type	IP54
Terminal Box	IP65
High-Resolution	□ 56.4 mm
PL Geared	□ 60 mm
TH Geared	□ 85 mm
SH Geared	□ 90 mm
2-Phase	Motor & Driver Package
5-Phase	Motor & Driver Package
Lead Wire/Connector	Accessories
Coupling	
Damper	
Mounting Bracket	

60 mm SH Geared Type



Specifications RoHS

Motor Specifications

Model Single Shaft Double Shaft	Connection Type	Current per Phase A/phase	Voltage V	Resistance per Phase Ω /phase	Inductance mH/phase	Rotor Inertia J: kg·m ²	Lead Wires	Wirings and Connections (See Page 76)
PK264AE-SG <input type="checkbox"/> PK264BE-SG <input type="checkbox"/>	Bipolar (Parallel)	2.8	1.96	0.7	1.4	120×10^{-7}	8	6
	Bipolar (Series)	1.4	3.9	2.8	5.6			5
	Unipolar	2	2.8	1.4	1.4			4

How to read specifications table → Page 78

- Degree of Protection: IP30
- Enter the gear ratio in the box () within the model name.
- Backlash value is approximately 1 to 2°.
- For the information of the applicable driver, please contact the nearest Oriental Motor sales office.

Note:

- Direction of rotation of the motor and that of the gear output shaft are the same for the gear ratios 1:3.6, 1:7.2, 1:9 and 1:10. It is the opposite for 1:18, and 1:36 gear ratios.

Gearmotor Specifications

Model Single Shaft Double Shaft	Gear Ratio	Holding Torque N·m	Step Angle	Permissible Speed r/min
PK264AE-SG3.6 PK264BE-SG3.6	1:3.6	1	0.5°	500
PK264AE-SG7.2 PK264BE-SG7.2	1:7.2	2	0.25°	250
PK264AE-SG9 PK264BE-SG9	1:9	2.5	0.2°	200
PK264AE-SG10 PK264BE-SG10	1:10	2.7	0.18°	180
PK264AE-SG18 PK264BE-SG18	1:18	3	0.1°	100
PK264AE-SG36 PK264BE-SG36	1:36	4	0.05°	50

- Holding torque is the same regardless of the connection type, due to the permissible torque limit of the gearhead.

Dimensions (Unit = mm)

Model	Mass kg
PK264AE-SG <input type="checkbox"/> PK264BE-SG <input type="checkbox"/>	0.75

- Enter the gear ratio in the box () within the model name.

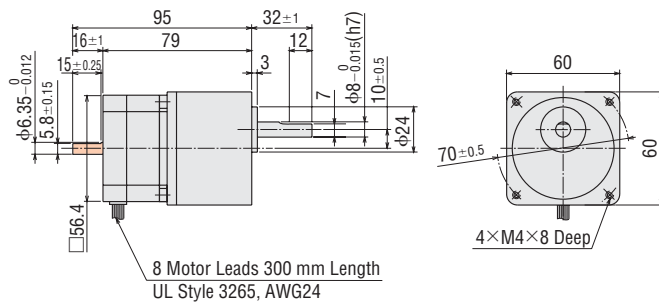

- These dimensions are for double shaft models. For single shaft models, ignore the orange () areas.
- Screws (Includes): M4 Length 15mm---4 pieces

Speed – Torque Characteristics

How to read speed – torque characteristics → Page 79

PK264AE-SG□/PK264BE-SG□

Bipolar (Series) 24 VDC

Bipolar Constant Current Driver Power Input: 24 VDC
Current: 1.4 A/Phase (Bipolar Series)
With Damper **D6CL-6.3F**: $J_L=140 \times 10^{-7} \text{ kg}\cdot\text{m}^2$

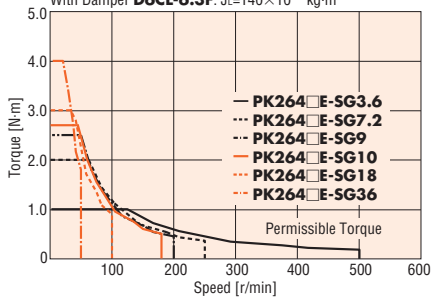

PK264AE-SG□/PK264BE-SG□

Unipolar 24 VDC

Unipolar Constant Current Driver Power Input: 24 VDC
Current: 2.0 A/Phase (Unipolar)
With Damper **D6CL-6.3F**: $J_L=140 \times 10^{-7} \text{ kg}\cdot\text{m}^2$

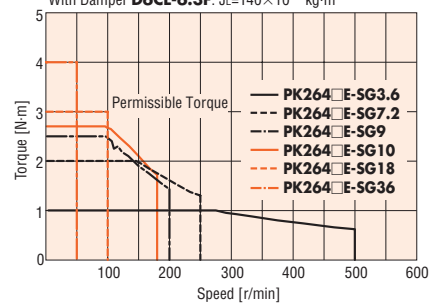

PK264AE-SG□/PK264BE-SG□

Bipolar (Series) 48 VDC

Bipolar Constant Current Driver Power Input: 48 VDC
Current: 1.4 A/Phase (Bipolar Series)
With Damper **D6CL-6.3F**: $J_L=140 \times 10^{-7} \text{ kg}\cdot\text{m}^2$

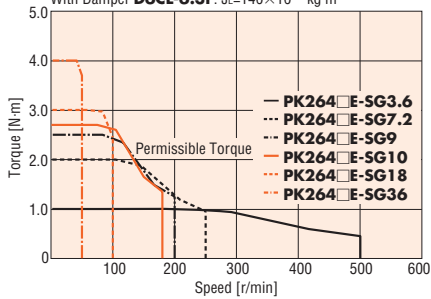

Note:

● Pay attention to heat dissipation from motor as there will be a considerable amount of heat under certain conditions. Be sure to keep the temperature of the motor case under 100°C.

High-Efficiency	<input type="checkbox"/> 28 mm
High-Torque	<input type="checkbox"/> 35 mm
Standard	<input type="checkbox"/> 42 mm
Cable Type	IP54
Terminal Box	IP55
High-Resolution	<input type="checkbox"/> 56.4 mm
PL Geared	<input type="checkbox"/> 60 mm
TH Geared	<input type="checkbox"/> 85 mm
SH Geared	<input type="checkbox"/> 90 mm
2-Phase	Motor & Driver Package
5-Phase	Motor & Driver Package
Lead Wire/Connector	Accessories
Coupling	
Damper	
Mounting Bracket	

85 mm

Step Angle 1.8°

Standard Type

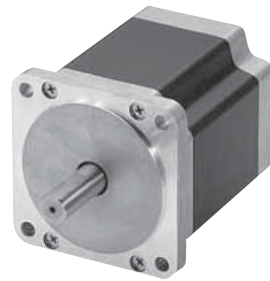

Specifications (RoHS)

Model Single Shaft Double Shaft	Connection Type	Holding Torque N·m	Current per Phase A/phase	Voltage V	Resistance per Phase Ω/phase	Inductance mH/phase	Rotor Inertia J: kg·m ²	Lead Wires	Wirings and Connections (See Page 76)	Corresponding Motor & Driver Package	
										Model	Page
PK296DA PK296DB	Bipolar	2.2	4.5	1.1	0.24	1.5	1400×10 ⁻⁷	4	[1]	RBK296A RBK296B	P.80
PK296-E4.5A PK296-E4.5B	Bipolar (Parallel)	3.1	6.3	1.4	0.24	1.5	1400×10 ⁻⁷	8	[6]	-	-
	Bipolar (Series)	3.1	3.18	2.8	0.96	6.0			[5]		
	Unipolar	2.2	4.5	2	0.48	1.5			[4]		
PK299DA PK299DB	Bipolar	4.4	4.5	1.5	0.33	2.5	2700×10 ⁻⁷	4	[1]	RBK299A RBK299B	P.80
PK299-E4.5A PK299-E4.5B	Bipolar (Parallel)	6.2	6.3	1.9	0.33	2.5	2700×10 ⁻⁷	8	[6]	-	-
	Bipolar (Series)	6.2	3.18	3.9	1.32	10.0			[5]		
	Unipolar	4.4	4.5	2.8	0.66	2.5			[4]		
PK2913DA PK2913DB	Bipolar	6.6	4.5	2.2	0.49	4.2	4000×10 ⁻⁷	4	[1]	RBK2913A RBK2913B	P.80
PK2913-E4.0A PK2913-E4.0B	Bipolar (Parallel)	9.3	5.6	2.6	0.49	4.2	4000×10 ⁻⁷	8	[6]	-	-
	Bipolar (Series)	9.3	2.8	5.3	1.94	16.8			[5]		
	Unipolar	6.6	4	3.8	0.97	4.2			[4]		

How to read specifications table → Page 78

● Degree of Protection: IP30

Dimensions (Unit = mm)

Model	L1	L2	Mass kg
PK296DA PK296-E4.5A	66	-	1.7
PK296DB PK296-E4.5B		100	
PK299DA PK299-E4.5A	96	-	2.8
PK299DB PK299-E4.5B		130	
PK2913DA PK2913-E4.0A	126	-	3.8
PK2913DB PK2913-E4.0B		160	

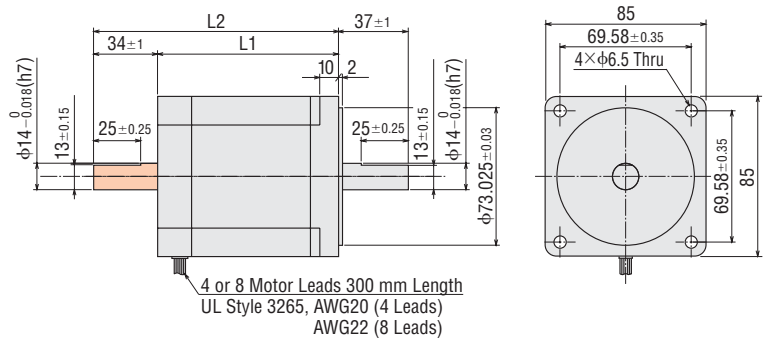

● These dimensions are for double shaft models. For single shaft models, ignore the orange (■) areas.

PK296DA/PK296DB

Bipolar

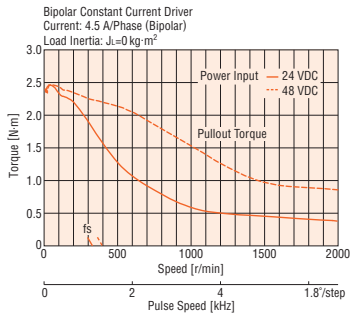

PK299DA/PK299DB

Bipolar

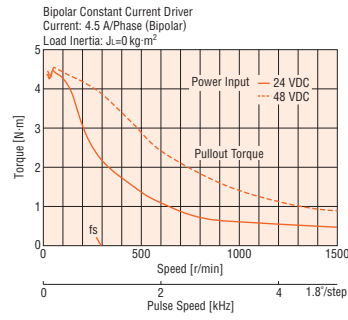

PK2913DA/PK2913DB

Bipolar

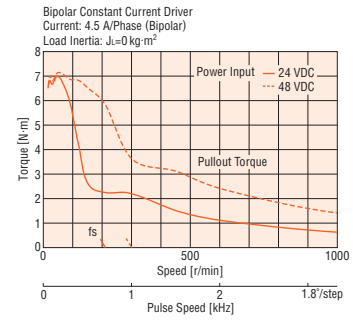

PK296-E4.5A/PK296-E4.5B

Bipolar (Parallel)

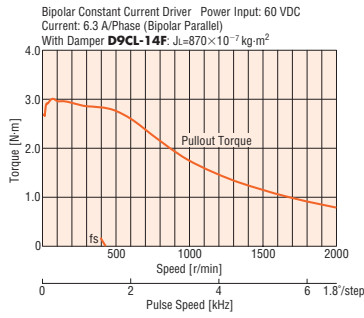

PK299-E4.5A/PK299-E4.5B

Bipolar (Parallel)

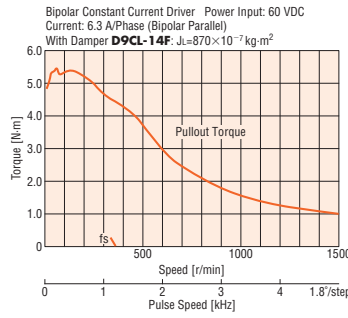

PK2913-E4.0A/PK2913-E4.0B

Bipolar (Parallel)

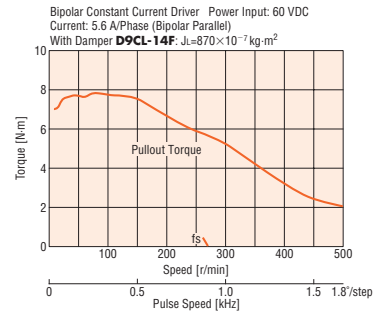

PK296-E4.5A/PK296-E4.5B

Bipolar (Series)

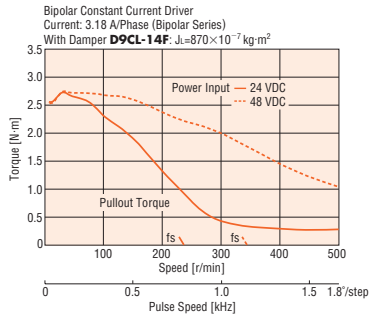

PK299-E4.5A/PK299-E4.5B

Bipolar (Series)

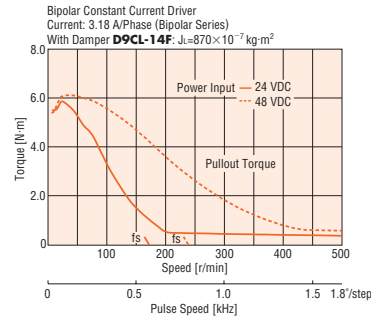

PK2913-E4.0A/PK2913-E4.0B

Bipolar (Series)

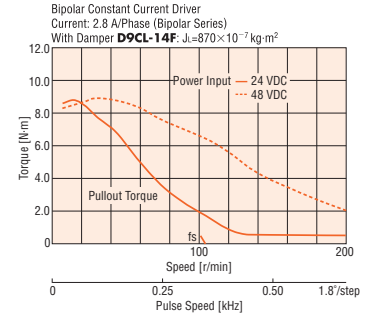

Note:

● Pay attention to heat dissipation from motor as there will be a considerable amount of heat under certain conditions. Be sure to keep the temperature of the motor case under 100°C.

High-Efficiency	<input type="checkbox"/> 28 mm
High-Torque	<input type="checkbox"/> 35 mm
Standard	<input type="checkbox"/> 42 mm
IP54 Cable Type	<input type="checkbox"/> 50 mm
Terminal Box	<input type="checkbox"/> 56.4 mm
High-Resolution	<input type="checkbox"/> 60 mm
PL Geared	<input type="checkbox"/> 85 mm
TH Geared	<input type="checkbox"/> 90 mm
SH Geared	<input type="checkbox"/> 90 mm
2-Phase	Motor & Driver Package
5-Phase	
Lead Wire/Connector	Accessories
Coupling	
Damper	
Mounting Bracket	

85 mm

Step Angle 1.8°
Standard Type IP54 Rated Motor with Cable

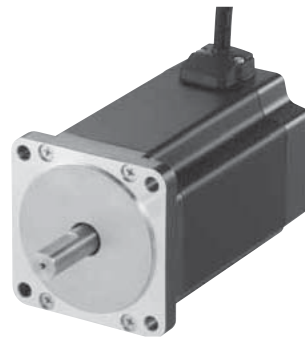

Specifications (RoHS)



Model Single Shaft	Connection Type	Holding Torque N·m	Current per Phase A/phase	Voltage V	Resistance per Phase Ω/phase	Inductance mH/phase	Rotor Inertia J: kg·m ²	Lead Wires	Wirings and Connections (See Page 76)
PK296DW	Bipolar	3.1	6.3	1.4	0.24	1.5	1400×10 ⁻⁷	4	[1]
PK299DW	Bipolar	6.2	6.3	1.9	0.33	2.5	2700×10 ⁻⁷	4	[1]
PK2913DW	Bipolar	9.3	5.6	2.6	0.49	4.2	4000×10 ⁻⁷	4	[1]

How to read specifications table → Page 78

- Degree of Protection: IP54 (Excluding the motor mounting surface)
- For the information of the applicable driver, please contact the nearest Oriental Motor sales office.

Dimensions (Unit = mm)

Model	L	Mass kg
PK296DW	75.5	2.0
PK299DW	105.5	3.1
PK2913DW	135.5	4.2

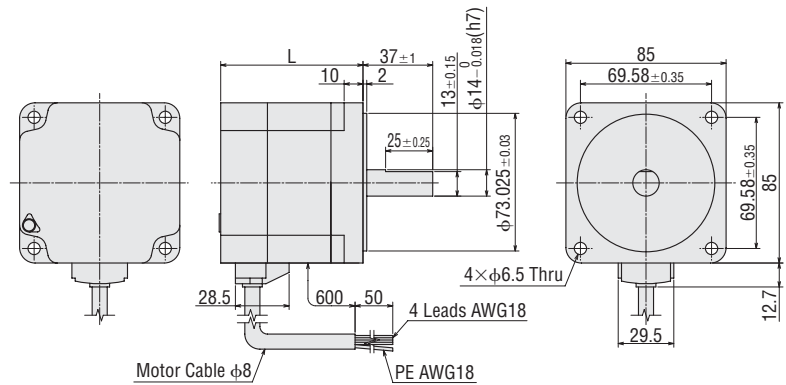

Speed – Torque Characteristics

How to read speed – torque characteristics → Page 79

PK296DW

Bipolar

Bipolar Constant Current Driver Power Input: 60 VDC
 Current: 6.3 A/Phase (Bipolar Parallel)
 Load Inertia: $J_L=870 \times 10^{-7} \text{ kg}\cdot\text{m}^2$

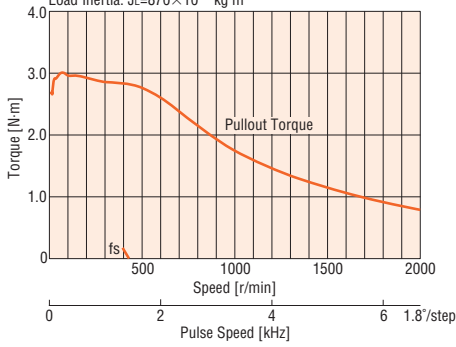

PK299DW

Bipolar

Bipolar Constant Current Driver Power Input: 60 VDC
 Current: 6.3 A/Phase (Bipolar Parallel)
 Load Inertia: $J_L=870 \times 10^{-7} \text{ kg}\cdot\text{m}^2$

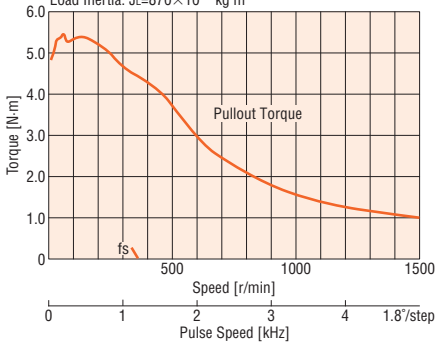

PK2913DW

Bipolar

Bipolar Constant Current Driver Power Input: 60 VDC
 Current: 5.6 A/Phase (Bipolar Parallel)
 Load Inertia: $J_L=870 \times 10^{-7} \text{ kg}\cdot\text{m}^2$

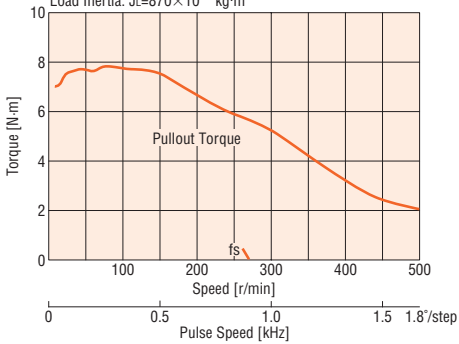

Note:

● Pay attention to heat dissipation from motor as there will be a considerable amount of heat under certain conditions. Be sure to keep the temperature of the motor case under 100°C.

High-Efficiency	28 mm	High-Torque	35 mm	Standard	42 mm	Cable Type	IP54	Terminal Box	IP65	High-Resolution	60 mm	PL Geared	95 mm	TH Geared	90 mm	SH Geared	2-Phase	5-Phase	Motor & Driver Package
																			Accessories
																			Lead Wire/Connector
																			Coupling
																			Damper
																			Mounting Bracket

85 mm

Step Angle 1.8°

Standard Type IP65 Rated Motor with Terminal Box

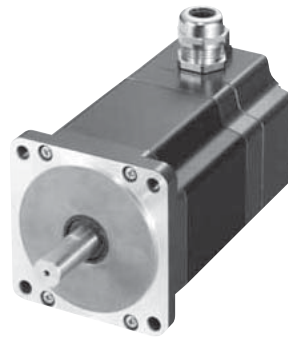

Specifications (RoHS)



Model Single Shaft	Connection Type	Holding Torque N·m	Current per Phase A/phase	Voltage V	Resistance per Phase Ω/phase	Inductance mH/phase	Rotor Inertia J: kg·m ²	Lead Wires (Terminals)	Wirings and Connections (See Page 76)	Corresponding Motor & Driver Package	
										Model	Page
PK296DT	Bipolar	2.2	4.5	1.1	0.24	1.5	1400×10 ⁻⁷	4	[7]	RBK296T	P.80
	Bipolar (Parallel)	3.1	6.3	1.4	0.24	1.5	1400×10 ⁻⁷	8	[9]		
PK296EAT	Bipolar (Series)	3.1	3.18	2.8	0.96	6.0			1400×10 ⁻⁷	8	[8]
	Unipolar	2.2	4.5	2	0.48	1.5	[10]				
PK299DT	Bipolar	4.4	4.5	1.5	0.33	2.5	2700×10 ⁻⁷	4	[7]	RBK299T	P.80
	Bipolar (Parallel)	6.2	6.3	1.9	0.33	2.5	2700×10 ⁻⁷	8	[9]		
PK299EAT	Bipolar (Series)	6.2	3.18	3.9	1.32	10.0			2700×10 ⁻⁷	8	[8]
	Unipolar	4.4	4.5	2.8	0.66	2.5	[10]				
PK2913DT	Bipolar	6.6	4.5	2.2	0.49	4.2	4000×10 ⁻⁷	4	[7]	RBK2913T	P.80
	Bipolar (Parallel)	9.3	5.6	2.6	0.49	4.2	4000×10 ⁻⁷	8	[9]		
PK2913EAT	Bipolar (Series)	9.3	2.8	5.3	1.94	16.8			4000×10 ⁻⁷	8	[8]
	Unipolar	6.6	4	3.8	0.97	4.2	[10]				

How to read specifications table → Page 78

● Degree of Protection: IP65 (Excluding the gap between the shaft and the flange)

Dimensions (Unit = mm)

Model	L	Mass kg
PK296DT PK296EAT	110	2.1
PK299DT PK299EAT	140	3.2
PK2913DT PK2913EAT	170	4.3

● Use cable (VCT) with a diameter of φ7~φ13 mm. Accessory motor cable (with protective earth wire, sold separately) is available → Page 90

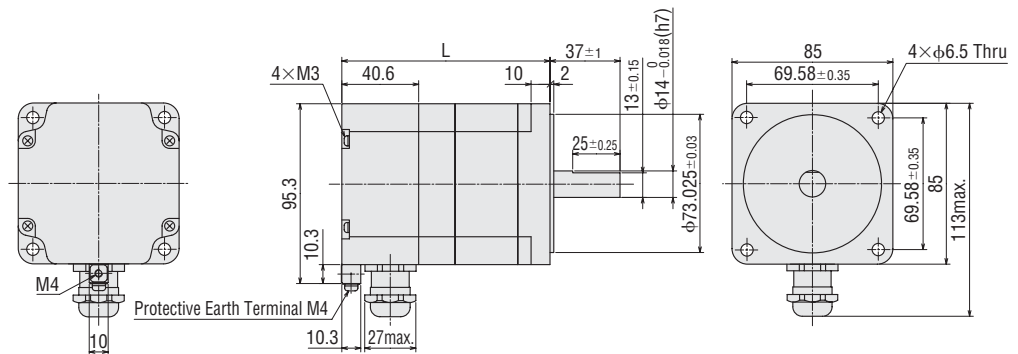

PK296DT

Bipolar

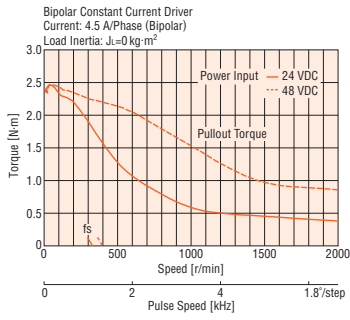

PK299DT

Bipolar

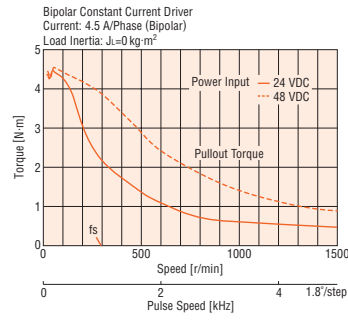

PK2913DT

Bipolar

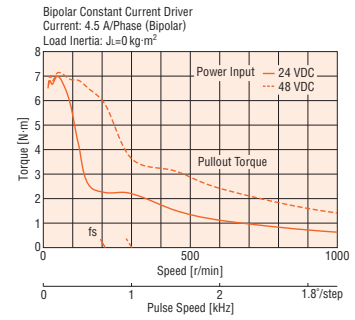

PK296EAT

Bipolar (Parallel)

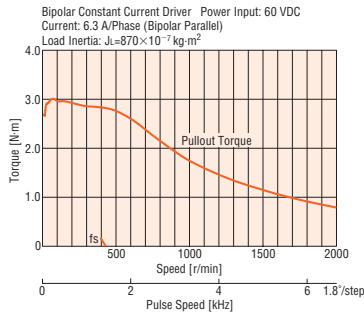

PK299EAT

Bipolar (Parallel)

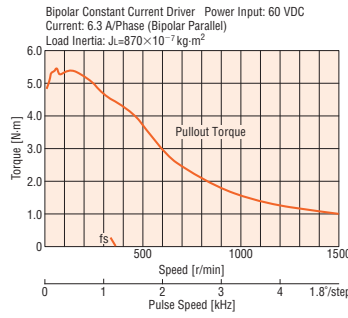

PK2913EAT

Bipolar (Parallel)

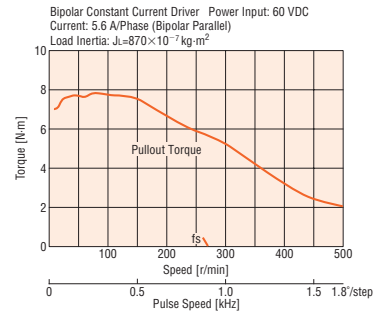

PK296EAT

Bipolar (Series)

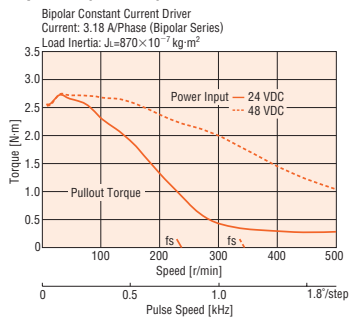

PK299EAT

Bipolar (Series)

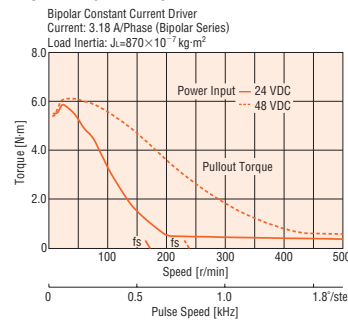

PK2913EAT

Bipolar (Series)

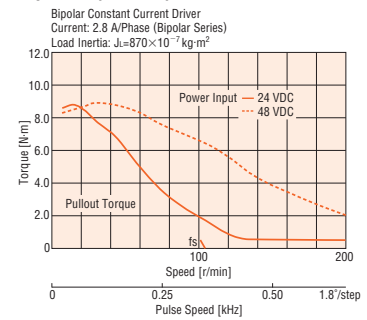

Note:

● Pay attention to heat dissipation from motor as there will be a considerable amount of heat under certain conditions. Be sure to keep the temperature of the motor case under 100°C.

High-Efficiency	<input type="checkbox"/> 28 mm
High-Torque	<input type="checkbox"/> 35 mm
Standard	<input type="checkbox"/> 42 mm
IP54 Cable Type	<input type="checkbox"/> 50 mm
Terminal Box	<input type="checkbox"/> 56.4 mm
High-Resolution	<input type="checkbox"/> 60 mm
PL Geared	<input type="checkbox"/> 85 mm
TH Geared	<input type="checkbox"/> 90 mm
SH Geared	<input type="checkbox"/> 90 mm
2-Phase	Motor & Driver Package
5-Phase	Motor & Driver Package
Lead Wire/Connector	Accessories
Coupling	
Damper	
Mounting Bracket	

90 mm SH Geared Type

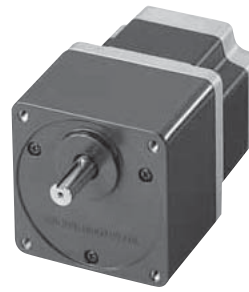

Specifications RoHS

Motor Specifications

Model Single Shaft Double Shaft	Connection Type	Current per Phase A/phase	Voltage V	Resistance per Phase Ω /phase	Inductance mH/phase	Rotor Inertia J: kg·m ²	Lead Wires	Wirings and Connections (See Page 76)
PK296AE-SG □ PK296BE-SG □	Bipolar (Parallel)	4.2	1	0.24	1.5	1400×10 ⁻⁷	8	[6]
	Bipolar (Series)	2.1	2	0.96	6.0			[5]
	Unipolar	3	1.4	0.48	1.5			[4]

How to read specifications table → Page 78

- Degree of Protection: IP30
- Enter the gear ratio in the box (□) within the model name.
- Backlash value is approximately 1 to 2°.
- For the information of the applicable driver, please contact the nearest Oriental Motor sales office.

Note:

- Direction of rotation of the motor and that of the gear output shaft are the same for the gear ratios 1:3.6, 1:7.2, 1:9, 1:10 and 1:18. It is the opposite for 1:36 gear ratios.

Gearmotor Specifications

Model Single Shaft Double Shaft	Gear Ratio	Holding Torque N·m	Step Angle	Permissible Speed r/min
PK296AE-SG3.6 PK296BE-SG3.6	1:3.6	2.5	0.5°	500
PK296AE-SG7.2 PK296BE-SG7.2	1:7.2	5	0.25°	250
PK296AE-SG9 PK296BE-SG9	1:9	6.3	0.2°	200
PK296AE-SG10 PK296BE-SG10	1:10	7	0.18°	180
PK296AE-SG18 PK296BE-SG18	1:18	9	0.1°	100
PK296AE-SG36 PK296BE-SG36	1:36	12	0.05°	50

- Holding torque is the same regardless of the connection type, due to the permissible torque limit of the gearhead.

Dimensions (Unit = mm)

Model	Mass kg
PK296AE-SG □ PK296BE-SG □	2.8

- Enter the gear ratio in the box (□) within the model name.

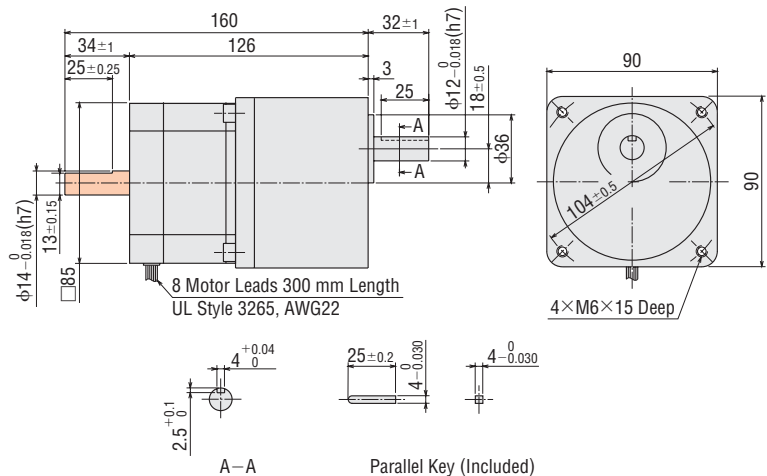

- These dimensions are for double shaft models. For single shaft models, ignore the orange (■) areas.
- Screws (Includes): M6 Length 18mm×4 pieces

Speed – Torque Characteristics

How to read speed – torque characteristics → Page 79

PK296AE-SG□/PK296BE-SG□

Bipolar (Series) 24 VDC

Bipolar Constant Current Driver Power Input: 24 VDC
 Current: 2.1 A/Phase (Bipolar Series)
 With Damper **D9CL-14F**: $J_L=870 \times 10^{-7} \text{ kg}\cdot\text{m}^2$

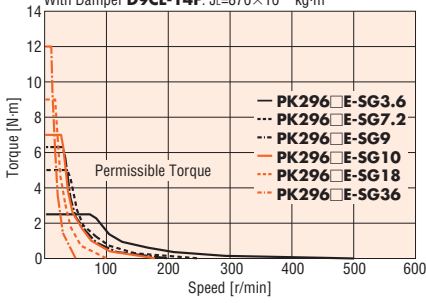

PK296AE-SG□/PK296BE-SG□

Unipolar 24 VDC

Unipolar Constant Current Driver Power Input: 24 VDC
 Current: 3.0 A/Phase (Unipolar)
 With Damper **D9CL-14F**: $J_L=870 \times 10^{-7} \text{ kg}\cdot\text{m}^2$

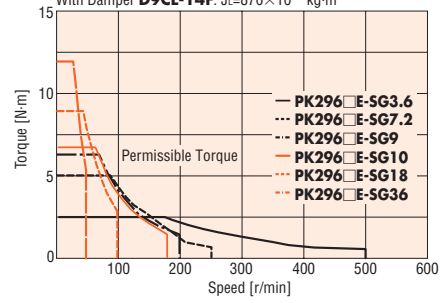

PK296AE-SG□/PK296BE-SG□

Bipolar (Series) 48 VDC

Bipolar Constant Current Driver Power Input: 48 VDC
 Current: 2.1 A/Phase (Bipolar Series)
 With Damper **D9CL-14F**: $J_L=870 \times 10^{-7} \text{ kg}\cdot\text{m}^2$

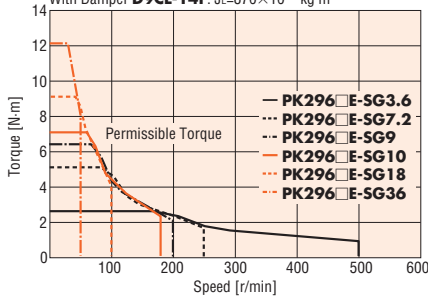

Note:

● Pay attention to heat dissipation from motor as there will be a considerable amount of heat under certain conditions. Be sure to keep the temperature of the motor case under 100°C.

High-Efficiency	<input type="checkbox"/> 28 mm
High-Torque	<input type="checkbox"/> 35 mm
Standard	<input type="checkbox"/> 42 mm
Cable Type	IP54
Terminal Box	IP55
High-Resolution	<input type="checkbox"/> 56.4 mm
PL Geared	<input type="checkbox"/> 60 mm
TH Geared	<input type="checkbox"/> 85 mm
SH Geared	<input checked="" type="checkbox"/> 90 mm
2-Phase	Motor & Driver Package
5-Phase	
Lead Wire/Connector	Accessories
Coupling	
Damper	
Mounting Bracket	

Encoder Specifications

The HEDS-5540 Series encoder by Avago Technologies Limited are used.

Absolute Maximum Ratings

Item	Symbol	Min.	Max.	Note
Supplied Voltage (V)	V_{CC}	-0.5	7	-
Output Voltage (V)	V_O	-0.5	V_{CC}	-
Output Voltage/Channel (mA)	I_{OUT}	-1.0	5	-
Vibration (Hz)	-	5	1000	20G
Rotation Speed (r/min)	-	-	30000	-
Rotation Acceleration (rad/sec ²)	-	-	250000	-

Recommended Operating Ranges

Item	Symbol	Min.	Typ.	Max.	Note
Supplied Voltage (V)	V_{CC}	4.5	5.0	5.5	Ripple < 100 mVp-p
Load Capacity (pF)	C_L	-	-	100	2.7 k Ω , pull-up
Response Frequency (kHz)	f	-	-	100	Rotating Speed $\times \frac{N}{60}$ (r/min)

- The encoder specifications are designed to guarantee operation based on a response frequency of 100 kHz. However, the encoder can be operated at a minimum response frequency of 100 kHz.
- 2.7 k Ω pull-up resistors are required.

Electrical Characteristics

3-Channel Type HEDS-5540 Series

Item	Symbol	Min.	Typ.*	Max.	Note
Supply Current (mA)	I_{CC}	30	57	85	-
Output Voltage "High" (V)	V_{OH}	2.4	-	-	$I_{OH} = -200 \mu A$ max.
Output Voltage "Low" (V)	V_{OL}	-	-	0.4	$I_{OL} = 3.86 mA$
Rise Time (ns)	t_r	-	180	-	$C_L = 25 pF$ $R_L = 2.7 k\Omega$ pull-up
Fall Time (ns)	t_f	-	40	-	

- The characteristic value above assume operation under the recommended operating conditions.
- *Typ. values are based on $V_{CC} = 5.0 V$ and $T_A = 25^\circ C$.

Encoder Characteristics

Item	Symbol	Min.	Typ.*	Max.
Pulse Width Error ($^\circ e$)	ΔP	-	5	35
Logic Width Error ($^\circ e$)	ΔS	-	5	35
Phase Error ($^\circ e$)	$\Delta \theta$	-	2	15
Position Error (arc minute)	$\Delta \phi$	-	10	40
Cycle Error ($^\circ e$)	ΔC	-	3	5.5
Index Pulse Width ($^\circ e$)	P_0	55	90	125
Rise Time of Index Pulse (ns) [Temperature: $-10 \sim +50^\circ C$]	t_1	10	100	250
Fall Time of Index Pulse (ns) [Temperature: $-10 \sim +50^\circ C$]	t_2	70	100	1000

- The characteristic value above assume operation under the recommended operating conditions. Each characteristic value indicates the worst value within one rotation of the code wheel.
- *Typ. values are based on $V_{CC} = 5.0 V$ and $T_A = 25^\circ C$.

Output Waveform

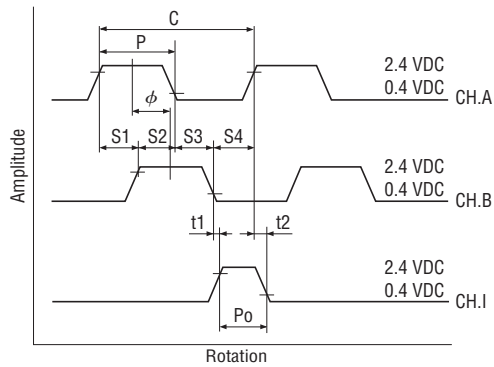

Electrical Interface

We recommend that the CH.A, CH.B and CH.I outputs are pulled up with a resistance of 2.7 k Ω ($\pm 10\%$) in order to shorten the rise time of the output pulse. Install a pull-up resistor near encoder (within 1 m).

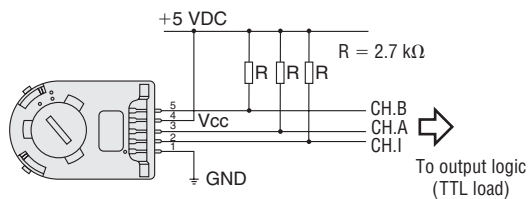

Applicable Encoder Connector

Connector Model	Manufacturer
640442-5	Tyco Electronics AMP
HEDS-8903 (For 3-Channel: 5-lead wires)	Avago Technologies Limited
2695 Series (Housing)	Molex
2759 Series (Contact)	

General Specifications

Specifications		Motor
Insulation Class		Class B (130°C) [Standard type with terminal box: Recognized class A (105°C) by UL/CSA Standards]
Insulation Resistance		100 MΩ or more when 500 VDC megger is applied between the windings and case under normal ambient temperature and humidity.
Dielectric Strength		Sufficient to withstand 1.0 kV at 50 Hz or 60 Hz applied between the windings and the case for 1 minute, under normal ambient temperature and humidity. (0.5 kV: For motor frame size 28 mm, 35 mm and 42 mm 1.5 kV: For standard type IP54 rated motor with cable, standard type IP65 rated motor with terminal box, and PK29□D)
Operating Environment (In Operation)	Ambient Temperature	-10~+50°C (non-freezing)
	Ambient Humidity	85% or less (no-condensing)
	Atmosphere	No corrosive gases, dust, water or oil (Standard type with terminal box: No corrosive gases or oil)
Temperature Rise		· Unipolar: Temperature rise of windings measured by the resistance change method are 80°C or less (at rated voltage, at standstill, two phases energized) · Bipolar: Temperature rise of windings measured by the resistance change method are 80°C or less (at rated current, at standstill, two phases energized) A heat radiating plate (material: aluminum) should be attached to the following motors. PK22□PD, PK23□PD, PK24□D : 115×115×5 mm PK24□PD : 175×175×5 mm PK26□D : 250×250×10 mm *For PK26□JD , the specifications are the same as unipolar model.
Stop Position Accuracy *1		±3 arc minute (±0.05°) [PK26□J, PK26□JD : ±2 arc minute (±0.034°)]
Shaft Runout		0.05T.I.R. (mm)*4
Radial Play *2		0.025mm Maximum of 5 N
Axial Play *3		0.075mm Maximum of 10 N
Concentricity		0.075T.I.R. (mm)*4
Perpendicularity		0.075T.I.R. (mm)*4

*1 This value is for full step under no load. (The value changes with the size of the load.)

*2 Radial Play: Displacement in shaft position in the radial direction, when a 5 N load is applied in the vertical direction to the tip of the motor's shaft.

*3 Axial Play: Displacement in shaft position in the axial direction, when a 10 N load is applied to the motor's shaft in the axial direction.

*4 T.I.R. (Total Indicator Reading): The total dial gauge reading when the measurement section is rotated one revolution centered on the reference axis center.

● Enter the motor case length in the box (□) within the model name.

Note:

● Do not measure insulation resistance or perform the dielectric strength test while the motor and driver are connected.

Safety Standards and CE Marking

Model	Standards	Certification Body	Standards File No.	CE Marking
PK26□DW PK29□DW* PK26□DAT, PK26□D1T PK29□DT, PK29□EAT	UL 1004 UL 2111 CSA C22.2 No.100 CSA C22.2 No.77	UL	E64199	Low Voltage Directive
PK26□DW PK29□DW PK26□DAT, PK26□D1T PK29□DT, PK29□EAT	EN 60034-1 EN 60034-5 EN 60950-1 EN 60664-1	Conform to EN standards		

● Enter the motor case length in the box (□) within the model name.

* **PK29□DW** is under application.

High-Efficiency	□28 mm
High-Torque	□35 mm
Standard	□42 mm
IP54 Cable Type	□50 mm
IP65 Terminal Box	□56.4 mm
High-Resolution	□60 mm
PI Geared	□85 mm
TH Geared	□90 mm
SH Geared	Motor & Driver Package
2-Phase	5-Phase
Lead Wire/Connector	Accessories
Coupling	
Damper	
Mounting Bracket	

■ Permissible Overhung Load and Permissible Thrust Load

Unit=N

Type	Model	Gear Ratio	Permissible Overhung Load					Permissible Thrust Load		
			Distance from Shaft End (mm)							
			0	5	10	15	20			
High-Efficiency	PKE244	-	20	25	34	52	-	The permissible thrust load shall be no greater than the motor mass.		
High-Torque	PK223P, PK224P, PK225P		25	34	52	-	-			
	PK233P, PK235P		20	25	34	52	-			
	PK244P, PK246P		20	25	34	52	-			
	PK264P, PK266P, PK268P		61	73	90	110	160			
	PK264J, PK266J, PK267J, PK269J		50	60	75	100	150			
Standard	PK243, PK244, PK245		20	25	34	52	-			
	PK256, PK258		54	67	89	130	-			
	PK264, PK266, PK268		54	67	89	130	-			
	PK296, PK299, PK2913		260	290	340	390	480			
High-Resolution	PK243M, PK244M, PK245M		20	25	34	52	-			
	PK264M, PK266M, PK268M		54	67	89	130	-			
PL Geared Type	PK244P-P <input type="checkbox"/>		5, 10	73	84	100	123		-	50
	PK244P-P36		36	109	127	150	184		-	50
	PK266P-P5		5	200	220	250	280		320	100
	PK266P-P10	10	250	270	300	340	390	100		
	PK264P-P36	36	330	360	400	450	520	100		
TH Geared Type	PK243-T <input type="checkbox"/>	3.6, 7.2, 10, 20, 30	10	14	20	30	-	15		
	PK264-T <input type="checkbox"/>	3.6, 7.2, 10, 20, 30	70	80	100	120	150	40		
SH Geared Type	PK223-SG <input type="checkbox"/>	7.2, 9, 10, 18, 36	15	17	20	23	-	10		
	PK243-SG <input type="checkbox"/>	3.6, 7.2, 9, 10, 18, 36, 50, 100	10	15	20	30	-	15		
	PK264-SG <input type="checkbox"/>	3.6, 7.2, 9, 10	30	40	50	60	70	30		
		18, 36	80	100	120	140	160			
PK296-SG <input type="checkbox"/>	3.6, 7.2, 9, 10, 18, 36	220	250	300	350	400	100			

● Enter the gear ratio in the box () within the model name.

Installation

Motor Installation

Motors can be mounted freely in any direction as shown below. Regardless of how the motor is mounted, take care not to apply an overhung load or thrust load on the shaft. Make sure the cable does not contact the mounting surface causing undesirable force on the cable.

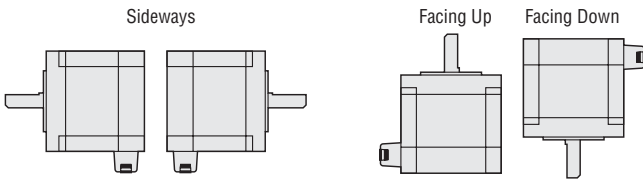

Notes:

- Do not disassemble the motors.
- Do not apply any shock to the motor.

Mounting Method

Considering heat radiation and vibration isolation as much as possible, mount the motor tightly against a metal plane.

Mounting Method for Through Hole Type

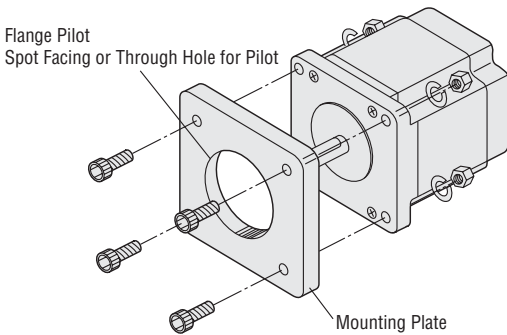

Model	Thickness of the Mounting Plate
PK256 PK258 PK264, PK264P, PK264J, PK264D, PK264M PK266, PK266P, PK266J, PK266D, PK266M PK267J PK268, PK268P, PK268J, PK268D, PK268M PK269J	5 mm minimum
PK296, PK296E, PK296D PK299, PK299E, PK299D PK2913, PK2913E, PK2913D	8 mm minimum

Mounting Method for Tapped Hole Type

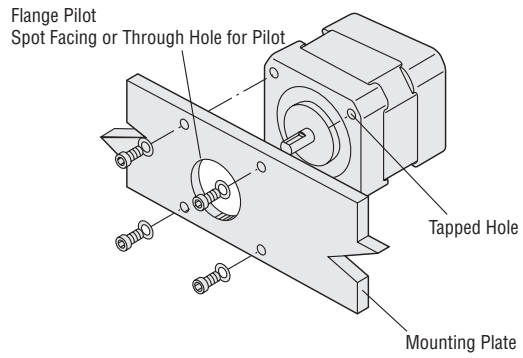

Model	Thickness of the Mounting Plate
PKE244, PKE244D	3 mm minimum
PK223P PK224P PK225P	2 mm minimum
PK233P PK235P PK243, PK243D, PK243M PK244, PK244P, PK244D, PK244M PK245, PK245D, PK245M PK246P PK223P-SG PK243-SG	3 mm minimum
PK243-T , PK244PD-P , PK264-SG , PK264-T	5 mm minimum
PK264PD-P , PK266PD-P , PK296-SG	8 mm minimum

● Enter the gear ratio in the box () within the model name.

Installation Conditions

Install the motor in a location that meets the following conditions, or the product may be damaged.

- Indoors (This product is designed and manufactured to be installed within another device.)
- Ambient temperature: -10 to +50°C (non-freezing)
- Ambient humidity: 85% or less (non-condensing)
- Not exposed to explosive, flammable or corrosive gases
- Not exposed to direct sunlight
- Not exposed to dust (except for motors with terminal box)
- Not exposed to water or oil (except for motors with terminal box)
- A place where heat can escape easily
- Not exposed to continuous vibration or excessive impact

Notes:

- When installing the motor in an enclosed space such as a control box, or somewhere close to a heat-radiating object, vent holes should be used to prevent the motor from overheating.
- Do not install the motor in a location where a source of vibration will cause the motor to vibrate.

High-Efficiency	28 mm	Motor & Driver Package
High-Torque	35 mm	Motor & Driver Package
Standard	42 mm	Motor & Driver Package
Cable Type	50 mm	Motor & Driver Package
Terminal Box	56.4 mm	Motor & Driver Package
High-Resolution	60 mm	Motor & Driver Package
PL Geared	85 mm	Motor & Driver Package
TH Geared	90 mm	Motor & Driver Package
SH Geared	90 mm	Motor & Driver Package
2-Phase		Accessories
5-Phase		Accessories
Lead Wire/Connector		Accessories
Coupling		Accessories
Damper		Accessories
Mounting Bracket		Accessories

■ Wirings and Connections

● High-Efficiency Type, High-Torque Type, Standard Type, High-Resolution Type and Geared Type

◇ Motor Wirings

● 4 Leads Motor

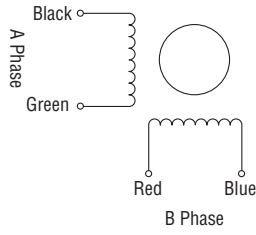

● 6 Leads Motor

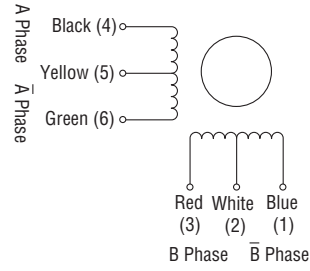

● 8 Leads Motor

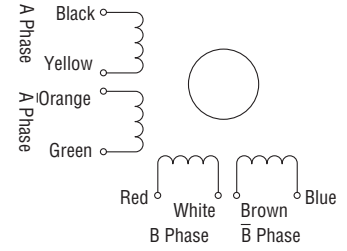

◇ Wirings Connection Diagrams

1 4 Leads Bipolar Connection

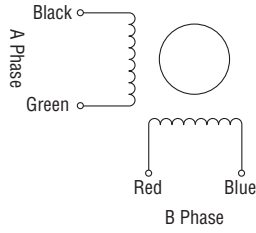

2 6 Leads Unipolar Connection

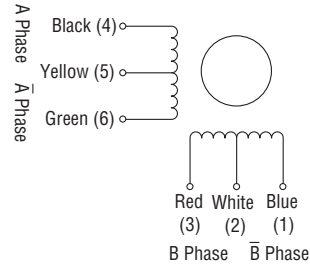

3 6 Leads Bipolar (Series) Connection

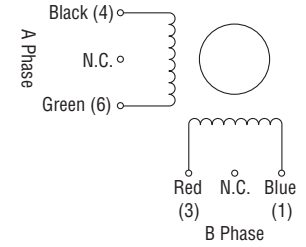

4 8 Leads Unipolar Connection

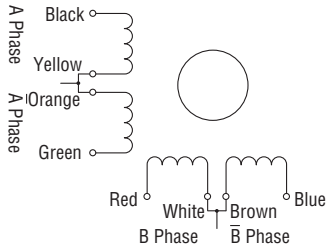

5 8 Leads Bipolar (Series) Connection

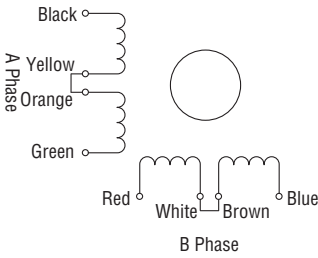

6 8 Leads Bipolar (Parallel) Connection

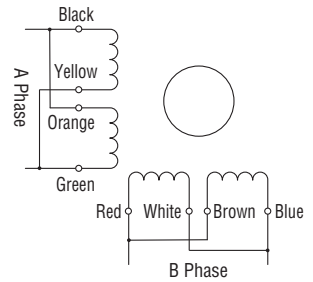

Notes:

- The numbers inside the parentheses indicate the connector pin No. of the high-efficiency type and high-torque type.
- N.C.: No Connection

● **Standard Type IP65 Rated Motor with Terminal Box**

◇ **Motor Wirings**

● **PK26 □ DAT, PK26 □ D1T**

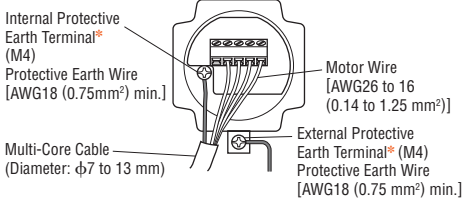

Connect motor lead wires to the terminals 2 to 5.

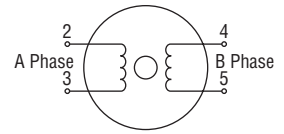
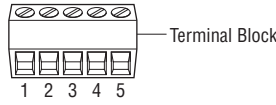

* Use either the internal or external protective earth terminal for grounding.

● **PK29 □ EAT**

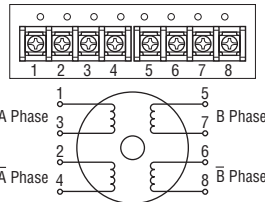
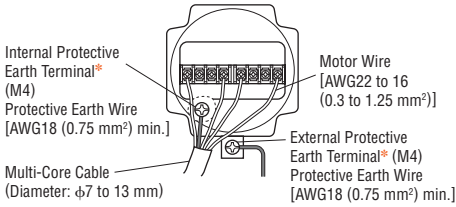

* Use either the internal or external protective earth terminal for grounding.

◇ **Wirings Connection Diagrams**

● **PK26 □ DAT, PK26 □ D1T**

7 Bipolar

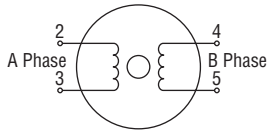

Connect motor lead wires to the terminals 2 to 5.

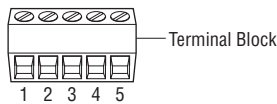

● **PK29 □ EAT**

8 Bipolar (Series)

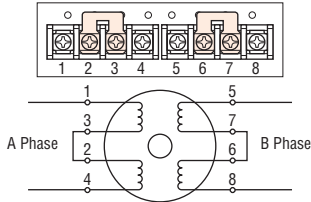

9 Bipolar (Parallel)

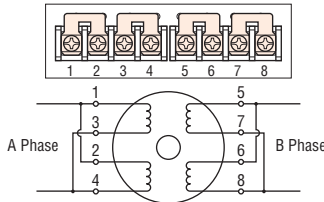

10 Unipolar

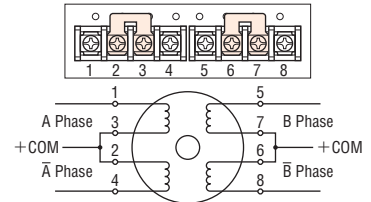

High-Efficiency	□ 28 mm	Motor & Driver Package
High-Torque	□ 35 mm	
Standard	□ 42 mm	
Cable Type	IP54	
Terminal Box	IP65	
High-Resolution	□ 56.4 mm	
PI Geared	□ 60 mm	
TH Geared	□ 85 mm	
SH Geared	□ 90 mm	
Accessories	Lead Wire/ Connector	
	Coupling	
	Damper	
	Mounting Bracket	

How to Read Specification Table

Motor Specifications

Model Single Shaft Double Shaft	① Connection Type	② Holding Torque N·m	③ Current per Phase A/phase	Voltage V	Resistance per Phase Ω/phase	Inductance mH/phase	④ Rotor Inertia J: kg·m ²	Lead Wires	Wirings and Connections (See Page 76)	Corresponding Motor & Driver Package	
										Model	Page
PK264DA PK264DB	Bipolar	0.48	4.2	1.25	0.3	0.6	120×10 ⁻⁷	4	①	RBK264A RBK264B	P.80
PK264-01A PK264-01B	Bipolar (Series)	0.48	0.71	8.1	11.4	21.6	120×10 ⁻⁷	6	③	-	-
	Unipolar	0.39	1	5.7	5.7	5.4			②		
PK264-02A PK264-02B	Bipolar (Series)	0.48	1.4	3.9	2.8	5.6	120×10 ⁻⁷	6	③	-	-
	Unipolar	0.39	2	2.8	1.4	1.4			②		
PK264-03A PK264-03B	Bipolar (Series)	0.48	2.1	2.6	1.26	2.4	120×10 ⁻⁷	6	③	-	-
	Unipolar	0.39	3	1.9	0.63	0.6			②		
PK264-E2.0A PK264-E2.0B	Bipolar (Parallel)	0.48	2.8	1.96	0.7	1.4	120×10 ⁻⁷	8	⑥	-	-
	Bipolar (Series)	0.48	1.4	3.9	2.8	5.6			⑤		
	Unipolar	0.39	2	2.8	1.4	1.4			④		

Gearmotor Specifications

Model Single Shaft Double Shaft	⑤ Gear Ratio	Holding Torque N·m	Step Angle	⑥ Backlash arc min (degrees)	⑦ Permissible Speed r/min
PK266PDA-P5-L, PK266PDA-P5 PK266PDB-P5-L, PK266PDB-P5	1:5	3.5	0.36°	20 (0.33)	360
PK266PDA-P10-L, PK266PDA-P10 PK266PDB-P10-L, PK266PDB-P10	1:10	5	0.18°	20 (0.33)	180
PK264PDA-P36-L, PK264PDA-P36 PK264PDB-P36-L, PK264PDB-P36	1:36	8	0.05°	20 (0.33)	50

① Connection Type

Connection type indicates the type of driving method of stepping motor. Refer to page 76 and 77 for the wirings and connections of each type.

② Maximum Holding Torque

The holding torque (2-phase excitation) is the maximum holding power (torque) the stepping motor has when power (rated current) is being supplied but the motor is not rotating (with consideration given to the permissible strength of the gear when applicable).

③ Rated Current

The rated current is determined by motor temperature rise. It is the current value that can flow to the motor coils continuously at motor standstill. As a general rule, the current must be set to the rated current.

④ Rotor Inertia

This refers to the inertia of rotor inside the motor. This is necessary when the required torque (acceleration torque) for the motor needs is calculated.

⑤ Gear Ratio (For geared motor)

This is the ratio in rotation speed between the input speed from the motor and the speed of the gear output shaft. For example, the gear ratio 1:10 is that when the input speed from the motor is 10 r/min, the gear output shaft is 1 r/min.

⑥ Backlash (For geared motor)

This is the play of gear output shaft when the motor shaft is fixed. When positioning in bi-direction, the positioning accuracy is affected.

Since the range of backlash angle cannot be controlled, minimizing the backlash will help improve the accuracy of positioning.

Oriental Motor provides the low-backlash **PL** and **TH** geared types.

⑦ Permissible Speed (For geared motor)

This is the rotation speed that the motor can be operated at with the gear output shaft.

How to Read Speed – Torque Characteristics

The graph below is the characteristics that indicate the relationship between the speed and torque when a stepping motor is driven. The required speed and torque is always used when selecting a stepping motor. On the graph, the horizontal axis expresses the speed at motor output shaft while the vertical axis expresses the torque.

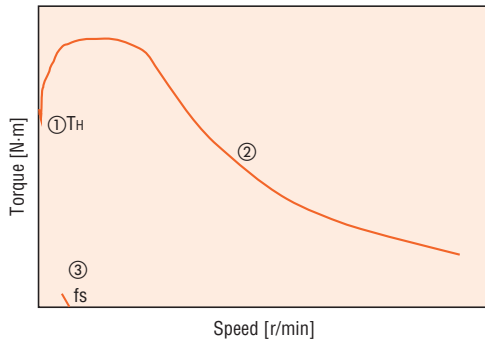

The speed – torque characteristics are determined by the motor and driver, so they vary greatly based upon the type of the driver used.

① Maximum Holding Torque

Maximum holding torque is the stepping motor's maximum holding power (torque) when power is supplied (at rated current) when the motor is not rotating.

② Pullout Torque

Pullout torque is the maximum torque that can be output at a given speed. When selecting a motor, be sure the required torque falls within this curve.

③ Maximum Starting Frequency (fs)

This is the maximum pulse speed at which the motor can start or stop instantly (without an acceleration or deceleration period) when the frictional load and inertial load of the stepping motor are 0. Driving the motor at greater than this pulse speed requires gradual acceleration or deceleration. This frequency drops when there is a load inertia on the motor.

High-Efficiency	High-Torque	Standard	IP54 Cable Type	IP65 Terminal Box	High-Resolution	PI Geared	TH Geared	SH Geared	Motor & Driver Package	2-Phase	5-Phase	Lead Wire/ Connector	Coupling	Damper	Mounting Bracket
□ 28 mm	□ 35 mm	□ 42 mm	□ 50 mm	□ 56.4 mm	□ 60 mm	□ 85 mm	□ 90 mm								
Accessories															

Product Line of Stepping Motor and Driver Package

2-Phase Stepping Motor and Driver Package RBK Series

The **RBK** Series is a motor and driver package consisting of a 2-phase stepping motor and DC input microstep driver.

Includes Oriental Motor's proprietary Smooth Drive Function to easily achieve low vibration operation.

 (Terminal box type motor only)

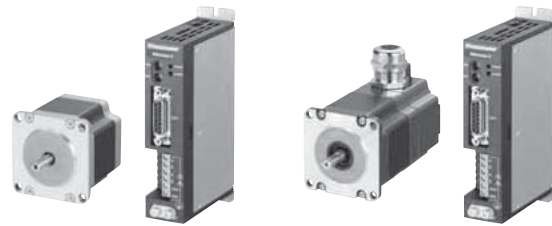

Standard Type Motor

Terminal Box Type Motor

Features

Smooth Drive Function

The Smooth Drive Function is a function that automatically controls the motor's microstep drive operation at the same travel and speed as in the full-step mode, without the operator having to change the speed settings of the driver's pulse input. It enables low vibration operation available with the microstep drive to be achieved with the flick of a switch.

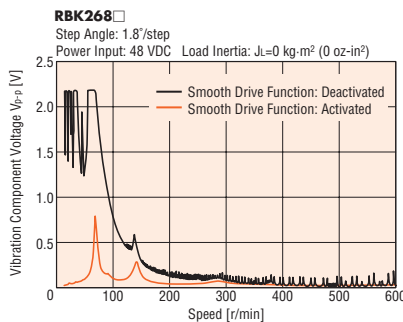

Microstep Function

The microstep driver electronically divides the basic step angle of the motor (1.8°/step) by up to 128 without the use of a reduction mechanism or other mechanical element. 16 different resolutions levels are available. The available range of resolution settings is 200 (1.8°/step) to 25600 (0.0140625°/step). The step angle can be easily set using the built-in switches on the driver. This function enables low vibration and low noise operation.

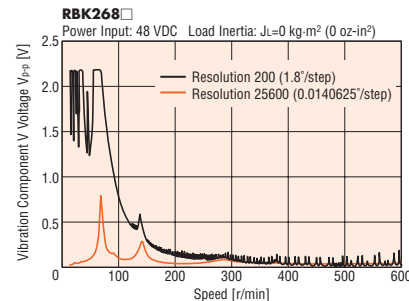

Third Harmonic Waveform Correction Function

This function corrects motor drive current waveforms. It provides improved angle accuracy and reduced vibration.

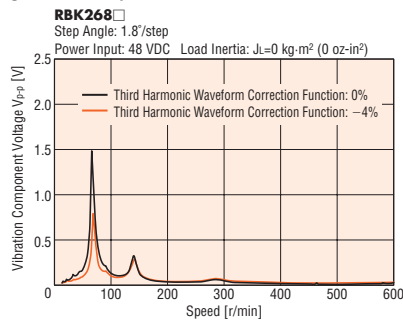

Vibration Suppression Function

This function improves vibrations in the medium speed range of stepping motors. It enables reduced risk of missteps due to vibrations.

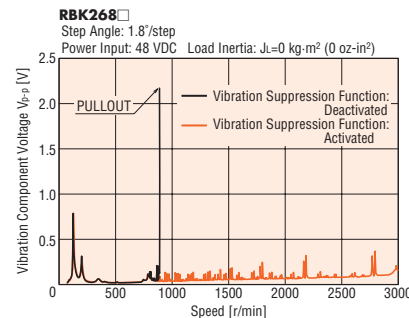

Wide Voltage Range Driver

The **RBK** Series utilizes a constant current driver with a wide voltage range of 20 to 75 VDC and up to 4.5 A/phase effective value (6.3 A/phase peak value). This enables it to support a wide range of power sources.

Comparison of Speed - Torque Characteristics

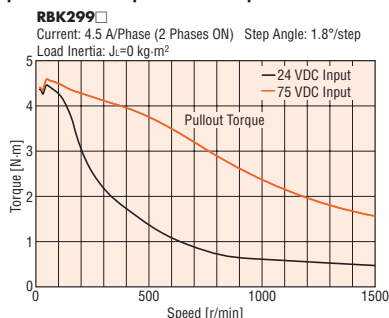

● Raising the power supply voltage enables increased torque during high speed operation.

● Product Line

Motor Frame Size	Type	Model		Maximum Holding Torque N-m	Basic Stap Angle	Power Source	
		Single Shaft	Double Shaft				
□28 mm	High-Torque Type	RBK223PA	RBK223PB	0.065	1.8°	20~40 VDC 1.7 A	
		RBK224PA	RBK224PB	0.097			
		RBK225PA	RBK225PB	0.11			
□35 mm	High-Torque Type	RBK233PA	RBK233PB	0.2			
		RBK235PB	RBK235PB	0.37			
□42 mm	High-Torque Type	RBK244PA	RBK244PB	0.48			
		RBK246PA	RBK246PB	0.93			
	PL Geared Type	RBK244PA-P5	RBK244PB-P5	1			0.36°
		RBK244PA-P10	RBK244PB-P10	1.5			0.18°
		RBK244PA-P36	RBK244PB-P36	3			0.05°
□56.4 mm	High-Torque Type	RBK264PA	RBK264PB	0.6	1.8°	20~40 VDC 3.7 A	
		RBK266PA	RBK266PB	1.4			
		RBK268PA	RBK268PB	2.3			
	Standard Type	RBK264A	RBK264B	0.48			
		RBK266A	RBK266B	1.17			
		RBK268A	RBK268B	1.75			
	Terminal Box Type	RBK264T	—	0.48			
		RBK266T	—	1.17			
		RBK268T	—	1.75			
	□60 mm	PL Geared Type	RBK266PA-P5	RBK266PB-P5			3.5
RBK266PA-P10			RBK266PB-P10	5	0.18°		
RBK264PA-P36			RBK264PB-P36	8	0.05°		
□85 mm	Standard Type	RBK296A	RBK296B	2.2	1.8°	20~75 VDC 5.2 A	
		RBK299A	RBK299B	4.4			
		RBK2913A	RBK2913B	6.6			
	Terminal Box Type	RBK296T	—	2.2			
		RBK299T	—	4.4			
		RBK2913T	—	6.6			

□28 mm	High-Efficiency
□35 mm	High-Torque
□42 mm	Standard
□50 mm	Cable Type
□56.4 mm	Terminal Box
□60 mm	High-Resolution
□85 mm	PL Geared
□90 mm	TH Geared
Motor & Driver Packages	SH Geared
	2-Phase
	5-Phase
Accessories	Lead Wire/Connector
	Coupling
	Damper
	Mounting Bracket

2-Phase Stepping Motor and Driver Package CMK Series

The **CMK** Series is a motor and driver package consisting of a 2-phase stepping motor and 24 VDC input microstep driver, allowing for a reduction in the size of your equipment and in vibration.

Features

◇ Achieving Low Vibration and Noise in a Microstep Drive

The newly designed DC board-level microstepping driver is compact and lightweight. The 2-phase stepping motor's basic step angle (1.8°/step) is divided by a maximum of 16 resolutions (0.1125°/step) without the use of a reduction mechanism or other mechanical elements, which contributes to the reduction in noise and vibration of your equipment.

Microstep/Step	Resolution	Step Angle
1	200	1.8°
2	400	0.9°
4	800	0.45°
8	1600	0.225°
16	3200	0.1125°

(At basic step angle 1.8°/step)

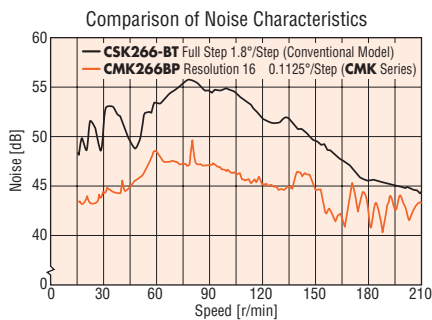
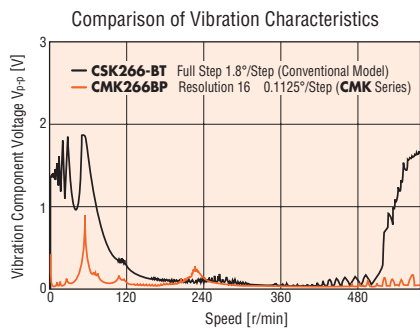

◇ Full Range of Driver Functions

- Five preset step angles
- Operating current can easily be set with a digital switch
- 1-pulse/2-pulse input mode switching
- Power LED
- Connector with lock (by MOLEX)

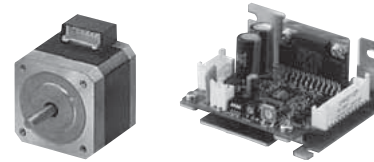

◇ One of the Smallest Microstep Drivers in the Industry

The **CMK** Series driver is one of the smallest, lightest microstep driver in the industry. The driver is 62% lighter and has 41% less install area (based on horizontal installation) compared to our conventional model. This product contributes to downsizing of your equipment.

Mass: 130g

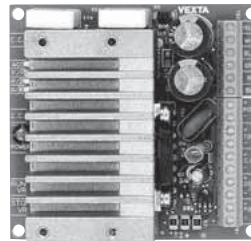

Conventional Model

Mass: 50g

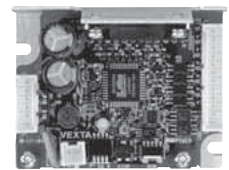

CMK Series Driver

Comparison with a conventional driver

- ◇ Mass: **62%** less
- ◇ Install area: **41%** less (based on horizontal installation)
- ◇ Volume: **41%** less [the conventional driver includes a 5 mm (0.2 in.) spacer for installation.]

◇ Easy-to-Install Heat Sink Shape

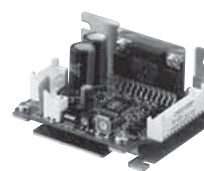

Horizontal Installation



Vertical Installation

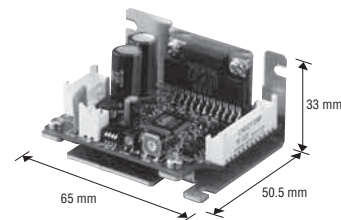

● **Wide Motor Variety**

The **CMK** Series motor and driver package comes in six frame sizes of 28 to 60 mm as well as five motor types.

● **Product Line**

Motor Frame Size	Type	Model		Maximum Holding Torque N·m	Basic Step Angle	Power Source	
		Single Shaft	Double Shaft				
□28 mm	High-Torque Type	CMK223PAP	CMK223PBP	0.05	1.8°	24 VDC±10% 1.5 A	
		CMK224PAP	CMK224PBP	0.075			
		CMK225PAP	CMK225PBP	0.09			
	SH Geared Type	CMK223AP-SG7.2	CMK223BP-SG7.2	0.3			0.25°
		CMK223AP-SG9	CMK223BP-SG9				0.18°
		CMK223AP-SG10	CMK223BP-SG10				0.1°
		CMK223AP-SG18	CMK223BP-SG18				0.05°
□35 mm	High-Torque Type	CMK233PAP	CMK233PBP	0.16	1.8°	24 VDC±10% 1.7 A	
		CMK235PAP	CMK235PBP	0.3			
□42 mm	High-Torque Type	CMK244PAP	CMK244PBP	0.39	0.9°	24 VDC±10% 1.5 A	
		CMK246PAP	CMK246PBP	0.75			
		Standard Type	CMK243AP	CMK243BP			0.16
	CMK244AP		CMK244BP	0.26	24 VDC±10% 1.7 A		
	CMK245AP		CMK245BP	0.32	24 VDC±10% 1.7 A		
	High-Resolution Type	CMK243MAP	CMK243MBP	0.16	0.5°	24 VDC±10% 1.5 A	
		CMK244MAP	CMK244MBP	0.26			
		CMK245MAP	CMK245MBP	0.32			
	SH Geared Type	SH Geared Type	CMK243AP-SG3.6	CMK243BP-SG3.6	0.2	0.25°	24 VDC±10% 1.5 A
			CMK243AP-SG7.2	CMK243BP-SG7.2	0.4	0.2°	
			CMK243AP-SG9	CMK243BP-SG9	0.5	0.18°	
			CMK243AP-SG10	CMK243BP-SG10	0.56	0.1°	
			CMK243AP-SG18	CMK243BP-SG18	0.8	0.05°	
			CMK243AP-SG36	CMK243BP-SG36		0.036°	
			CMK243AP-SG50	CMK243BP-SG50		0.018°	
		TH Geared Type	CMK243AP-SG100	CMK243BP-SG100	0.35	0.5°	
			CMK243AP-T3.6	CMK243BP-T3.6	0.7	0.25°	
CMK243AP-T7.2			CMK243BP-T7.2	1	0.18°		
CMK243AP-T10			CMK243BP-T10	1.5	0.09°		
□50 mm	Standard Type	CMK243AP-T20	CMK243BP-T20	1.5	0.06°	24 VDC±10% 2.9 A	
		CMK243AP-T30	CMK243BP-T30	1.5			
□50 mm	Standard Type	CMK256AP	CMK256BP	0.56	1.8°	24 VDC±10% 2.9 A	
		CMK258AP	CMK258BP	1.2			
		CMK264PAP	CMK264PBP	0.46			
□56.4 mm	High-Torque Type	CMK266PAP	CMK266PBP	0.99	0.9°	24 VDC±10% 2.9 A	
		CMK268PAP	CMK268PBP	1.73			
		CMK264AP	CMK264BP	0.36			
	Standard Type	CMK266AP	CMK266BP	0.82			
		CMK268AP	CMK268BP	1.35			
		CMK264MAP	CMK264MBP	0.37			
□60 mm	SH Geared Type	CMK266MAP	CMK266MBP	0.9	0.5°	24 VDC±10% 2.9 A	
		CMK268MAP	CMK268MBP	1.35			
		CMK264AP-SG3.6	CMK264BP-SG3.6	1			0.25°
		CMK264AP-SG7.2	CMK264BP-SG7.2	2			0.2°
		CMK264AP-SG9	CMK264BP-SG9	2.5			0.1°
		CMK264AP-SG10	CMK264BP-SG10	2.7			0.05°
		CMK264AP-SG18	CMK264BP-SG18	3			0.036°
	TH Geared Type	CMK264AP-SG36	CMK264BP-SG36	4	0.018°		
		CMK264AP-SG50	CMK264BP-SG50		1.25		0.5°
		CMK264AP-SG100	CMK264BP-SG100		2.5		0.25°
		CMK264AP-T3.6	CMK264BP-T3.6	3	0.18°		
		CMK264AP-T7.2	CMK264BP-T7.2	3.5	0.09°		
		CMK264AP-T10	CMK264BP-T10	4	0.06°		
		CMK264AP-T20	CMK264BP-T20				
CMK264AP-T30	CMK264BP-T30						

High-Efficiency	□28 mm
High-Torque	□35 mm
Standard	□42 mm
Cable Type	IP54
Terminal Box	IP55
High-Resolution	□56.4 mm
PL Geared	□60 mm
TH Geared	□85 mm
SH Geared	□90 mm
2-Phase	Motor & Driver Packages
5-Phase	
Lead Wire/ Connector	
Coupling	Accessories
Damper	
Mounting Bracket	

2-Phase Compact Linear Actuators DRB Series

The compact actuator has a ball screw output shaft that is built into the hollowed rotor. The ball screw nut rotates with the rotor, and the shaft moves forward and backward linearly by attaching an external anti-spin mechanism.

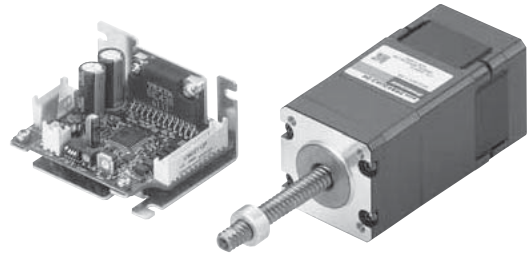

Features

◆ A Stepping Motor is Integrated with a Ball Screw

The **DRB** Series achieves high positioning accuracy in a space-saving design.



- A set collar (on the screw shaft), which prevents the screw from retracting completely into the case, is omitted in the figure below.

Screw Shaft

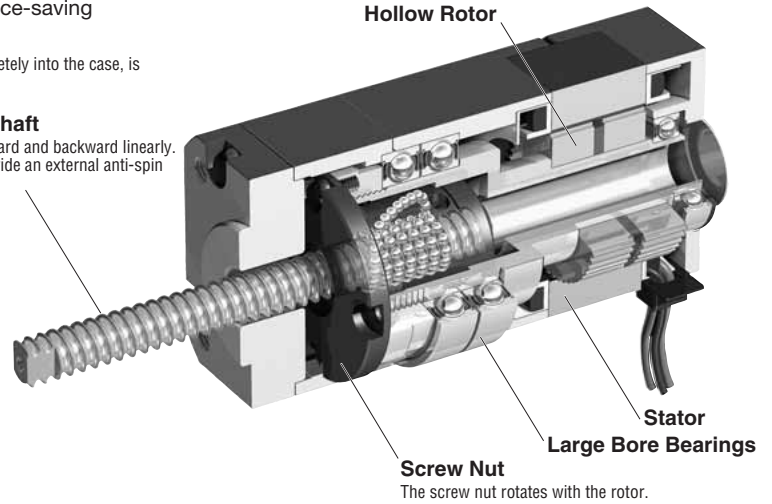
Moves forward and backward linearly. Always provide an external anti-spin mechanism.



Product Line

	DRB28	DRB42	DRB60
Frame Size	□28 mm	□42 mm	□60 mm
Thrust Force	25 N	70 N	200 N
Shape			

◆ With Adjusting Knob

The load position can be adjusted manually when the power is cut off. This function is useful during servicing of the equipment.

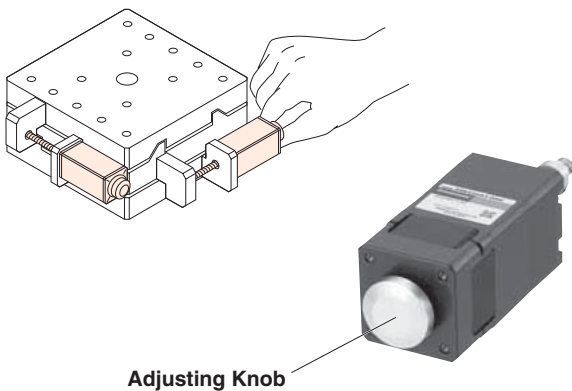

◆ Two Stroke Length

Two stroke length of the ball screw shaft, standard length and long-stroke length, are available in each frame size.



Frame Size (mm)		□28	□42	□60
Stroke Length (mm)	Standard	30	40	50
	Long-Stroke	60	100	100

● Applications

Fine & constant feeding of syringe

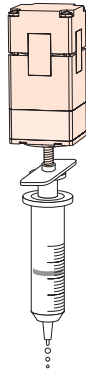

Focusing of a CCD camera

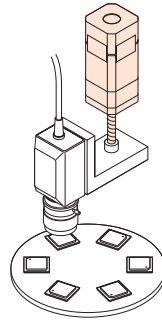

Vertical fine-tuning of table position

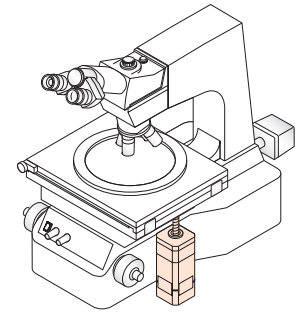

● Product Number Code

DRB 42 U A 2 - 04 N A

① ② ③ ④ ⑤ ⑥ ⑦ ⑧

①	DRB Series	
②	Frame Size	28: □28 mm 42: □42 mm 60: □60 mm
③	Motor Lead	6 Leads
④	Drive Method	Rolled Ball Screw Type
⑤	Lead	1: 1 mm 2: 2 mm 4: 4 mm
⑥	Stroke	03: 30 mm (□28 mm) 04: 40 mm (□42 mm) 05: 50 mm (□60 mm) 06: 60 mm (□28 mm) 10: 100 mm (□42 mm, □60 mm)
⑦	Additional Function	None: No Additional Function N: With Adjusting Knob
⑧	Driver Type	A: CMD21□□P None: Without Driver (Actuator alone)

● Actuator Specifications

Model	DRB28UA1-03A DRB28UA1-06A DRB28UA1-03NA	DRB42UA2-04A DRB42UA2-10A DRB42UA2-04NA	DRB60UA4-05A DRB60UA4-10A DRB60UA4-05NA	
Drive Method	Rolled Ball Bearing			
Max. Vertical Transportable Mass *1	kg	2.5	7	20
Maximum Speed *2	mm/s	24	30	32
Maximum Acceleration	m/s ²	0.2	0.4	0.26
Maximum Thrust Force *3	N	25	70	200
Maximum Holding Force	N	25	70	200
At Excitation *4	N	25	70	200
At Non-Excitation	N		0	
Repetitive Positioning Accuracy	mm	±0.03		
Lost Motion	mm	0.1		
Resolution *5	mm	0.005	0.01	0.02
Lead	mm	1	2	4
Stroke	mm	03: 30 06: 60	04: 40 10: 100	05: 50 10: 10
Mass (Mass with adjusting knob)	kg	03: 0.18 (0.19) 06: 0.18	04: 0.6 (0.6) 10: 0.63	05: 1.41 (1.46) 10: 1.49

*1 When the power is turned off, or output current is turned off (non-excitation state), the actuator loses its thrust force or holding force. As such, it can no longer keep the load in position or withstand an external force.

*2 Use each actuator at or below the following maximum speed in a low temperature environment (0 to +10°C)

DRB28: 15 mm/s, **DRB42:** 20 mm/s, **DRB60:** 24 mm/s

*3 The maximum thrust force is measured during constant-speed operation in horizontal operation with no load applied to the moving parts (screw shaft and joint). Thrust force varies with load mass and acceleration.

*4 The maximum holding force at excitation is the value when the automatic current cutback function is ON (40% of the rated current).

*5 Five resolutions can be set.

Note:

● Use the actuator in conditions where its surface temperature will not exceed 90°C. The repetitive positioning accuracy is measured at a specified temperature under a specified load.

High-Efficiency	□28 mm
High-Torque	□35 mm
Standard	□42 mm
IP54 Cable Type	□50 mm
IP55 Terminal Box	□56.4 mm
High-Resolution	□60 mm
PL Geared	□85 mm
TH Geared	□90 mm
SH Geared	□90 mm
2-Phase	Motor & Driver Packages
5-Phase	Motor & Driver Packages
Lead Wire/Connector	Accessories
Coupling	Accessories
Damper	Accessories
Mounting Bracket	Accessories

● Dimensions (Unit = mm)

◇ Actuator

Model	Additional Function	Actuator Model	Mass (kg)
DRB28UA1-03A	None	DRB28UA1-03	0.18
DRB28UA1-03NA	With Adjustment Knob	DRB28UA1-03N	0.19

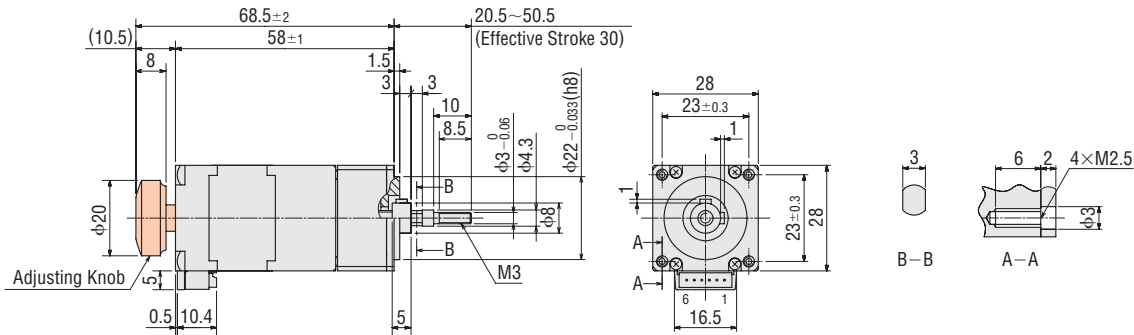

- The dimensions apply to a configuration with adjusting knob. For model without adjusting knob, the shaft and adjusting knob shown in shaded areas should be ignored.
- Motor lead wire/connector assembly of 0.6 m is included with the package. UL Style 3265, AWG24

Model	Additional Function	Actuator Model	Mass (kg)
DRB28UA1-06A	None	DRB28UA1-06	0.18

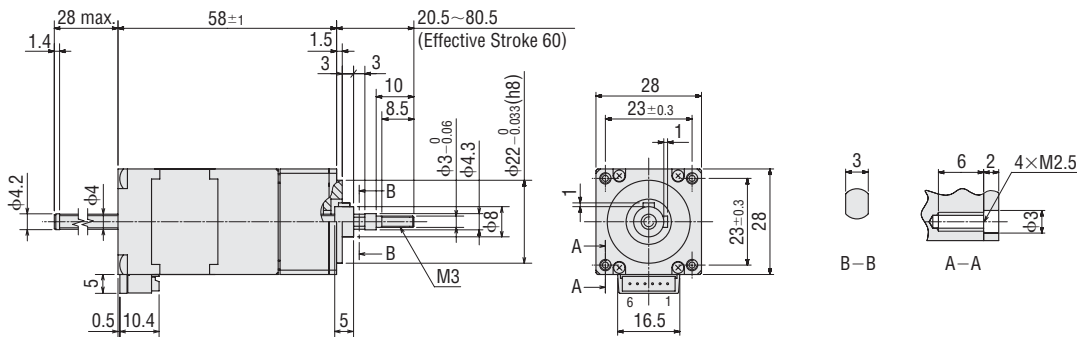

- Motor lead wire/connector assembly of 0.6 m is included with the package. UL Style 3265, AWG24

Model	Additional Function	Actuator Model	Mass (kg)
DRB42UA2-04A	None	DRB42UA2-04	0.6
DRB42UA2-04NA	With Adjustment Knob	DRB42UA2-04N	0.6

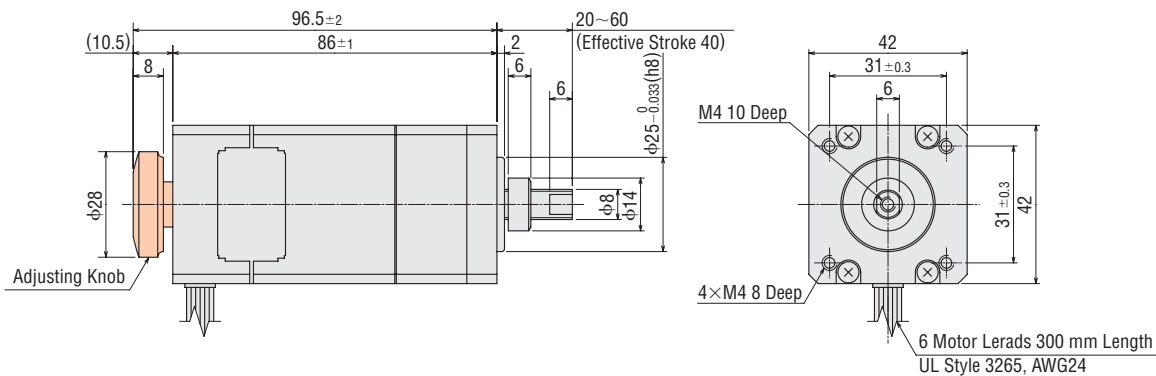

- The dimensions apply to a configuration with adjusting knob. For model without adjusting knob, the shaft and adjusting knob shown in shaded areas should be ignored.

Model	Additional Function	Actuator Model	Mass (kg)
DRB42UA2-10A	None	DRB42UA2-10	0.63

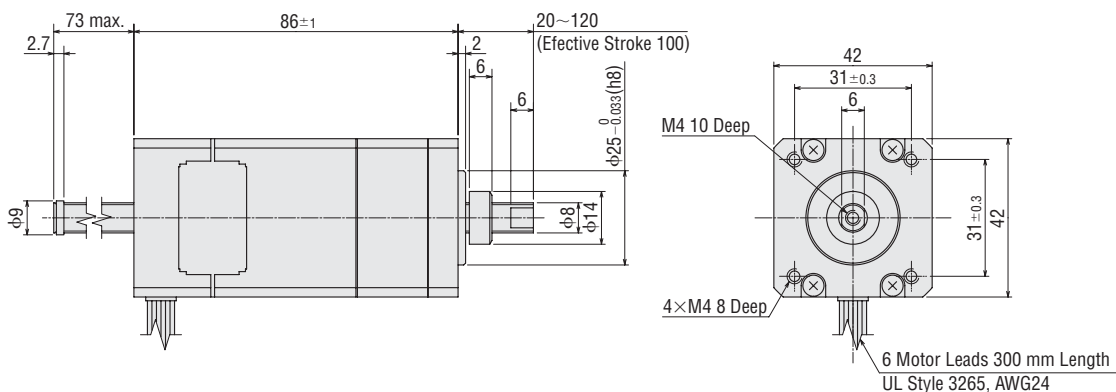

5-Phase Stepping Motor and Driver Packages (RoHS)

We recommend the 5-Phase Stepping Motor and Driver Package to get further reduction of vibration and noise.

DC Input 5-Phase Stepping Motor and Driver Package

CRK Series

- Compact and lightweight microstep driver
- Low vibration and noise achieved by microstep driver
- Smooth drive function for enhanced ease of use
- Various geared motors are available

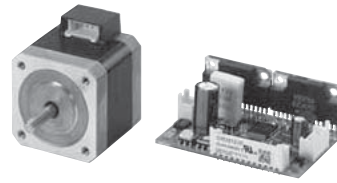

AC Input 5-Phase Stepping Motor and Driver Package

RK Series

- Safe operation in major countries around the world compliance with safety standards
- Low vibration and noise achieved by microstep driver
- Smooth drive function for enhanced ease of use
- Various geared motors are available
- Electromagnetic brake type and terminal box type is also available



Compact Linear Actuator

DRL Series (Adopting a 5-Phase Stepping Motor)



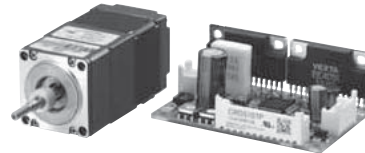

- Accurate positioning mechanism by a ball screw
- Enables accurate multi-point positioning
- Compact and lightweight microstep driver
- Actuators with adjusting knob, with electromagnetic brake, and with guide are available



Types and Features of Geared Motor

Four types of geared motors are available both in **CRK** Series and **RK** Series.

You can choose a suitable gear according to your application.

Geared Type	Features	Permissible Torque/ Maximum Torque [N-m]	Backlash [arc min]	Basic Resolution [deg/step]	Output Shaft Speed [r/min]
Low backlash	 <p>TH Geared (Parallel Shaft)</p> <ul style="list-style-type: none"> • A wide variety of low gear ratios for high-speed operation • Gear ratios: 1:3.6, 1:7.2, 1:10, 1:20, 1:30 	<p>CRK: 4 RK: 12</p>	<p>CRK: 60 RK: 45</p>	0.024	500
	 <p>PL Geared (Planetary)</p> <ul style="list-style-type: none"> • High permissible torque • A wide variety of gear ratios for selecting the desired step angle (resolution) • Centered output shaft • Gear ratios: 1:5, 1:7.2, 1:10, 1:25, 1:36, 1:50 	<p>CRK: 8 RK: 37</p>	35	0.0144	360
Non-backlash	 <p>PN Geared (Planetary)</p> <ul style="list-style-type: none"> • High speed (low gear ratio), high positioning precision • High permissible/maximum torque • A wide variety of gear ratios for selecting the desired step angle (resolution) • Centered output shaft • Gear ratios: 1:5, 1:7.2, 1:10, 1:25, 1:36, 1:50 	<p>Permissible Torque Maximum Torque</p> <p>CRK: 8 CRK: 20 RK: 37 RK: 60</p>	3	0.0144	600
	 <p>Harmonic Geared (Harmonic Drive)</p> <ul style="list-style-type: none"> • High positioning precision • High permissible/maximum torque • High gear ratio, high resolution • Centered output shaft • Gear ratios: 1:50, 1:100 	<p>Permissible Torque Maximum Torque</p> <p>CRK: 8 CRK: 28 RK: 37 RK: 55</p>	0	0.0072	70

Note:

- The values shown above must be used as reference. These values vary depending on the frame size and gear ratio.

● **Product Line**

The **CRK**, **RK** and **DRL** Series offer a range of motor frame sizes depending on the series and the motor type, as shown below.

Series	Type	Features	Frame Size				
			□20 mm	□28 mm (□30 mm)	□42 mm	□60 mm	□85 mm (□90 mm)
CRK Series	High-Resolution Type	A high-torque motor offering higher positioning accuracy with the basic step angle set to 0.36°/step, which is just half the basic step angle of the standard type.	-	✓	✓	✓	-
	High-Torque type	A high-torque motor generating high torque of approx. 1.3 to 1.5 times the level achieved by the standard type.	✓	✓	✓	-	-
	Standard Type	The basic model offering an optimal balance of torque, low vibration and low noise.	-	-	✓	✓	-
	TH Geared Type	A geared motor achieving both low backlash and low cost.	-	✓	✓	✓	-
	PL Geared Type	A geared motor offering low backlash, high strength and wide gear ratios.	-	-	✓	✓	-
	PN Geared Type	A high-accuracy, high strength geared motor achieving a backlash of 3 arc minutes or less.	-	✓	✓	✓	-
	Harmonic Geared Type	A high-accuracy, backlash-free geared motor adopting a harmonic gear. It ensures high strength in a compact body.	✓	-	✓	✓	-
RK Series	Standard Type	Easy-to-use standard type offer balanced performance.	-	-	-	✓	✓
	Standard Type with Terminal Box	This motor conforms to the IP65 standard for ingress protection against dust and water.	-	-	-	✓	✓
	Standard Type with Electromagnetic Brake	A motor combines with power off activated type electromagnetic brake.	-	-	-	✓	✓
	TH Geared Type	A geared motor achieving both low backlash and low cost.	-	-	-	✓	✓
	PL Geared Type	A geared motor offering low backlash, high strength and wide gear ratios.	-	-	-	✓	✓
	PN Geared Type	A high-accuracy, high strength geared motor achieving a backlash of 3 arc minutes or less.	-	-	-	✓	✓
	Harmonic Geared Type	A high-accuracy, backlash-free geared motor adopting a harmonic gear. It ensures high strength in a compact body.	-	-	-	✓	✓
DRL Series	Standard	A linear actuator adopting a ball screw and built-in large bore bearings.	✓	✓	✓	✓	-
	With Electromagnetic Brake	An actuator combines with power off activated type electromagnetic brake.	-	-	✓	✓	-
	With Adjusting Knob	The load position can be adjusted manually when the power is cut off.	✓	✓	✓	✓	-
	With Guide	An actuator comes with a guide provided as an anti-spin mechanism.	✓	✓	✓	✓	-

● For more information on **CRK** Series, **RK** Series and **DRL** Series, please contact the nearest Oriental Motor sales office.

High-Efficiency	□28 mm
High-Torque	□35 mm
Standard	□42 mm
IP54 Cable Type	□50 mm
IP65 Terminal Box	□56.4 mm
High-Resolution	□60 mm
PL Geared	□85 mm
TH Geared	□90 mm
SH Geared	Motor & Driver Packages
2-Phase	
5-Phase	
Lead Wire/Connector	Accessories
Coupling	
Damper	
Mounting Bracket	

Accessories

Motor Lead Wire/Connector Assembly (RoHS)

These lead wires with connectors are available for connection with the connector-coupled motor, eliminating the need for assembling a connector.

A motor lead wire/connector assembly of 0.6 m is included with the product which have “-L” at the end of the model name.



Model	Applicable Product	Number of Lead Wires	Length (m)
LC2U06A	PK22□P□	6	0.6
LC2U10A	PK223P□-SG□		1
LC2U06B	PK23□P□	6	0.6
LC2U10B	PK24□P□		1
LC2U06C	PK26□P□	6	0.6
LU2U10C			1

Model	Applicable Product	Number of Lead Wires	Length (m)
LC2B06A	PK22□PD□	4	0.6
LC2B06B	PK23□PD□	4	0.6
	PK24□PD□ PK244PD□-P□		
LC2B06C	PK26□PD□	4	0.6
	PK26□PD□-P□		

- Enter the motor case length in the box (□) within the model name.
- Enter **A** (single shaft) or **B** (double shaft) in the box (□) within the model name.
- Enter the gear ratio in the box (□) within the model name.

Motor Connector Set (RoHS)

A set of connector housings and contacts for use with connector-coupled motors.

Each package contains enough housings and contacts for 30 motors.



Model	Applicable Product
CS2U30A	PK22□P□
	PK22□PD□
	PK223P□-SG□
CS2U30B	PK23□P□
	PK23□PD□
	PK24□P□
	PK244□PD□
	PK244PD□-P□

- Enter the motor case length in the box (□) within the model name.
- Enter **A** (single shaft) or **B** (double shaft) in the box (□) within the model name.
- Enter the gear ratio in the box (□) within the model name.

Specifications

Model	Connector Housing	Contact	Applicable Crimp Tool	Manufacturer	Applicable Cable
CS2U30A	51065-0600	50212-8100	57176-5000	MOLEX	AWG30~24 (0.05~0.2 mm ²) Outer Sheath Diameter: ϕ 1.4 mm max. Strip Length: 1.3~1.8 mm
CS2U30B	51103-0600	50351-8100	57295-5000		AWG28~22 (0.08~0.3 mm ²) Outer Sheath Diameter: ϕ 1.15~1.8 mm Strip Length: 2.3~2.8 mm

- Note:**
- The crimp tool is not provided with the product. It must be purchased separately.

Motor Cable (RoHS) (For IP65 Rated Motor with Terminal Box)

A cable for connection between the IP65 rated motor with terminal box and driver (with protective earth wire).

Product Line

Model	Length (m)	Conductors
CC03PKT	3	6

- Conductor configuration: 6
- Conductor size: Motor wire AWG18 (0.75 mm²), protective earth wire AWG14 (2.0 mm²)
- Finished outer diameter: ϕ 12 mm
- Cable rating: 105°C 600 V
- Outer casing: Heat-resistant, oil-resistant vinyl chloride resin
- Applicable standards: UL 758 (AWM) VW-1, UL Style 2586

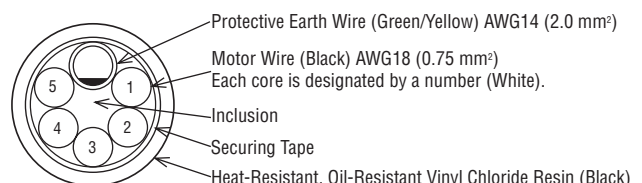

Flexible Coupling RoHS

A flexible coupling ideal for your motor is available. Once you have decided on a motor and gear, you can select the recommended coupling easily.



Features

This three-piece coupling adopts an aluminum alloy hub and a resin spider. The simple construction ensures that the high torque generated by a geared motor can be transmitted reliably. The proper elasticity of the spider suppresses motor vibration.

- High strength (usable for geared motor) has been realized.
- A spider (material: polyurethane) controls the vibration generated by the motor.
- No backlash

Coupling Selection Table

Motor Model	Gear Ratio	Motor Shaft Diameter (mm)	Coupling Type	Driven Shaft Diameter (mm)													
				φ4	φ5	φ6	φ6.35	φ8	φ10	φ12	φ14	φ15	φ16				
PK22□P□, PK22□PD□ PK23□P□, PK23□PD□ PK24□-01□, PK24□-02□, PK24□-03□, PK24□D□ PK24□M-01□, PK24□M-02□, PK24□M-03□	—	φ5	MCS14	●	●	●											
PK223P□-SG□	7.2, 9, 10, 18, 36																
PK243□1-SG□ PKE244□, PKE244D□ PK24□P□, PK24□PD□	3.6, 7.2																
PK243□1-SG□	9, 10, 18, 36, 50, 100	φ5			●	●	●	●									
PK243□1-T□, PK243D□-T□	3.6, 7.2, 10	φ6			●	●	●	●	●								
PK256-02□ PK264-01□, PK264-02□, PK264-03□, PK264-E2.0□ PK264D□, PK264DW, PK264DAT, PK264D1T PK264M-01□, PK264M-02□, PK264M-03□, PK26M-E2.0□ PK266-01□, PK266-02□, PK266-03□, PK266-E2.0□ PK266D□, PK266DW, PK266DAT, PK266D1T PK266M-01□, PK266M-02□, PK266M-03□, PK266M-E2.0□ PK264P□, PK264PD□, PK264J□, PK264JD□	—	φ6.35	MCS20		●	●	●	●	●								
PK244PD□-P5	5	φ8			●	●	●	●	●								
PK243□1-T□, PK243D□-T□	20, 30	φ6				●	●	●	●								
PK258-02□ PK268-01□, PK268-02□, PK268-03□, PK268-E2.0□ PK268D□, PK268DW, PK268DAT, PK268D1T PK268M-01□, PK268M-02□, PK268M-03□, PK268M-E2.0□ PK266P□, PK266PD□, PK268P□, PK268PD□ PK266J□, PK266JD□, PK267J□, PK267JD□	—	φ6.35				●	●	●	●								
PK244PD□-P10	10																
PK264□E-SG□	3.6, 7.2, 9, 10					●	●	●	●	●							
PK264□2-T□, PK264D□-T□	3.6, 7.2																
PK296-E4.5□ PK296D□, PK296DW, PK296EAT, PK296DT	—	φ14							●	●	●						
PK269J□, PK269JD□	—																
PK244PD□-P36	36								●	●	●			●			
PK264□E-SG□	18, 36																
PK264□2-T□, PK264D□-T□	10, 20, 30																
PK296□E-SG□	3.6, 7.2, 9																
PK266PD□-P5	5								●	●	●			●			
PK296□E-SG□	10, 18, 36																
PK266PD□-P10	10																
PK264PD□-P36	36																
PK299-E4.5□ PK299D□, PK299DW, PK299EAT, PK299DT PK2913-E4.0□ PK2913D□, PK2913DW, PK2913EAT, PK2913DT	—	φ14	MCS55									●	●	●	●		

- Enter the motor case length in the box (□) within the model name.
- Enter **A** (single shaft) or **B** (double shaft) in the box (□) within the model name.
- Enter the gear ratio in the box (□) within the model name.

High-Efficiency	High-Torque	Standard	IP54 Cable Type	Terminal Box	High-Resolution	PL Geared	TH Geared	SH Geared	2-Phase	5-Phase	Lead Wire/Connector	Coupling	Damper	Mounting Bracket
<input type="checkbox"/> 28 mm	<input type="checkbox"/> 35 mm	<input type="checkbox"/> 42 mm	<input type="checkbox"/> 50 mm	<input type="checkbox"/> 56.4 mm	<input type="checkbox"/> 60 mm	<input type="checkbox"/> 85 mm	<input type="checkbox"/> 90 mm	Motor & Driver Package						

● Coupling Specifications

Model	Dimensions					Normal Torque N·m	Mass g	Inertia kg·m ²	Static Torsion Spring Constant N·m/rad	Permissible Eccentricity mm	Permissible Declination deg	Permissible End Play mm
	Outer Diameter φA mm	Length mm	Axial Hole Diameter d1H7 mm	Axial Hole Diameter d2H7 mm	Key Slot Tolerance b/t mm							
MCS140405	14	22	4	5	—	0.5	6.7	0.184×10 ⁻⁶	22.9	0.06	0.9	+0.6 0
MCS140505			5	5								
MCS140506			5	6								
MCS200505	20	30	5	5	—	1.2	19.8	1.059×10 ⁻⁶	51.6	0.08	0.9	+0.8 0
MCS200506			5	6								
MCS2005F04			5	6.35								
MCS200508			5	8								
MCS200606			6	6								
MCS2006F04			6	6.35								
MCS200608			6	8								
MCS200610			6	10								
MCS20F04F04			6.35	6.35								
MCS20F0408			6.35	8								
MCS20F0410			6.35	10								
MCS200808			8	8								
MCS200810			8	10								
MCS300606			30	35								
MCS3006F04	6	6.35										
MCS300608	6	8										
MCS300610	6	10										
MCS30F04F04	6.35	6.35										
MCS30F0408	6.35	8										
MCS30F0410	6.35	10										
MCS300808	8	8										
MCS300810	8	10										
MCS300812	8	12										
MCS301014	10	14										
MCS301214	12	14										
MCS301414	14	14										
MCS301416	14	16										
MCS400808	40	66	8	8	φ8 b: 2±0.0125 t: 1 ^{+0.1} ₀	4.0	139	42.29×10 ⁻⁶	859.5	0.06	0.9	+1.2 0
MCS400810			8	10								
MCS400812			8	12								
MCS400815			8	15								
MCS401012			10	12								
MCS401212			12	12								
MCS401215	12	15										
MCS551212	55	78	12	12	φ14 b: 5±0.015 t: 2.3 ^{+0.1} ₀	14.3	282	109.1×10 ⁻⁶	2063	0.10	0.9	+1.4 0
MCS551214			12	14								
MCS551215			12	15								
MCS551216			12	16								
MCS551414			14	14								
MCS551415			14	15								
MCS551416	14	16										
					φ16 b: 5±0.015 t: 2.3 ^{+0.1} ₀							

● Dimensions (Unit = mm)

MCS14

Mass: 6.7 g

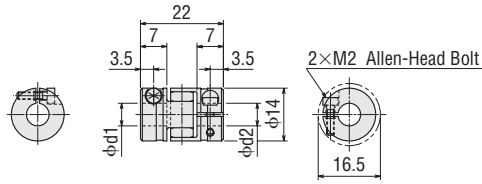

MCS20

Mass: 19.8 g

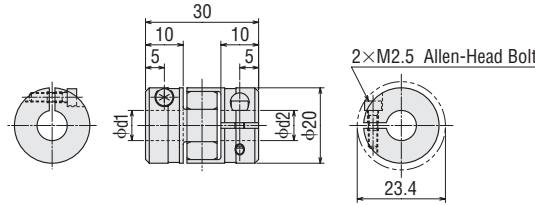

MCS30

Mass: 44.6 g

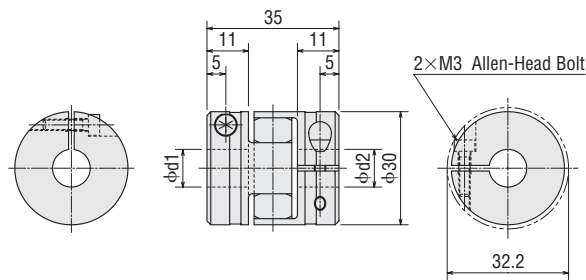

MCS40

Mass: 139 g

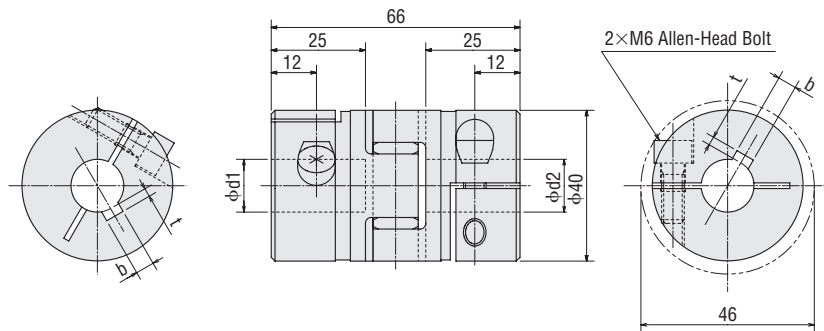

MCS55

Mass: 282 g

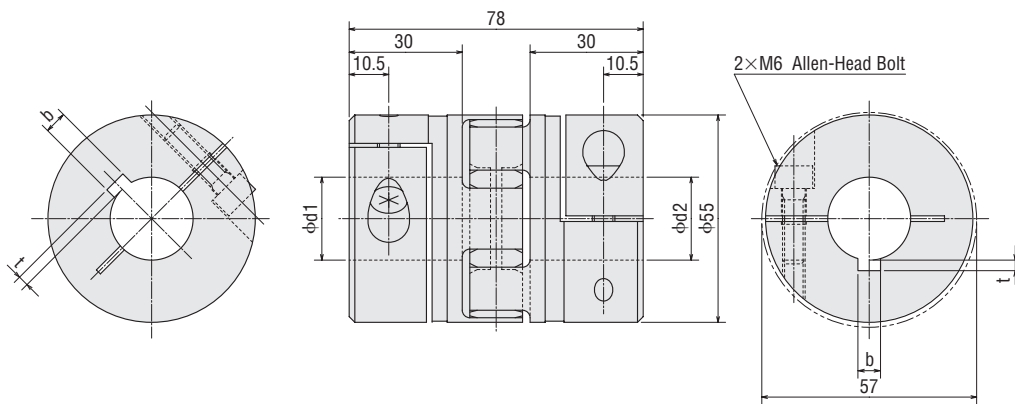

High-Efficiency	28 mm	High-Torque	35 mm	Standard	42 mm	IP54 Cable Type	50 mm	IP55 Terminal Box	56.4 mm	High-Resolution	60 mm	PL Geared	85 mm	TH Geared	90 mm	Motor & Driver Package
Lead Wire/Connector	Accessories															
Coupling																
Damper																
Mounting Bracket																

● **Mounting to a Shaft**

Clamp couplings use the tightening force of the screw to compress the shaft hole diameter and thereby fasten the coupling to the shaft. This does not damage the shaft and is easy to mount and remove.

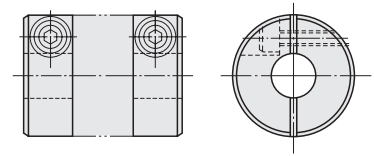

The following table shows the screw tightening torque. We recommend use of a torque wrench to fasten the coupling.

Type		MCS14	MCS20	MCS30	MCS40	MCS55
Tightening Torque	N·m	0.37	0.76	1.34	10.5	10.5

● **Alignment Adjustment**

Flexible couplings tolerate misalignment of the axis center and transfer rotational angle and torque, but produce vibration when the permissible value for misalignment is exceeded. This can dramatically shorten the coupling's service life. This requires alignment adjustment.

Misalignment of the axis center includes eccentricity (parallel error of both centers), declination (angular error of both centers) and end play (shaft movement in the axial direction). To keep misalignment within the permissible value, always check and adjust the alignment.

To increase the service life of the coupling, we recommend keeping misalignment below 1/3 of the permissible value.

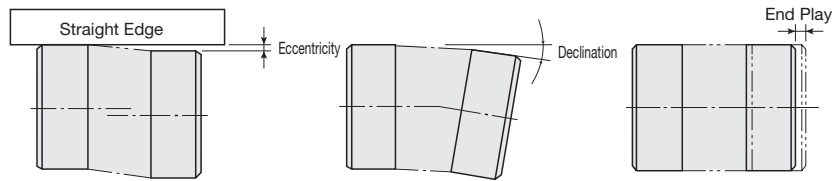

Notes:

- When misalignment exceeds the permissible value or excessive torque is applied, the coupling's shape will deform, and service life is shortened.
- When the coupling emits a metallic sound during operation, stop operation immediately and ensure there is no misalignment, axis interference or loose screws.
- When load changes are large, apply an adhesive to the coupling set screw to prevent it from loosening.

Clean Damper (RoHS)

Mechanical dampers suppress stepping motor vibration and improve high-speed performance. An inertia body and silicon gel are hermetically sealed in a plastic case.

Features

- Excellent vibration absorption
The doughnut-shaped internal inertia body and silicon gel absorb vibration. This feature enables a stable damping effect.
- Since there is no frictional dust as in conventional magnetic dampers, it can be used in environments where higher degrees of cleanliness is needed.
- High reliability
- It holds up well in harsh environments and changes little with age because the silicon gel and plastic case used are heat resistant.
- Machine part is sealed hermetically in a plastic case. This ensures safety and doesn't generate noise.
- This clean damper is an accessory for double shaft types. It can be used with various geared motors of double shaft type.

Product Line

Model	Applicable Motor
D4CL-5.0F	Motor Frame Size □42 mm or smaller
D6CL-6.3F	Motor Frame Size □56.4 mm and □60 mm, or smaller
D6CL-8.0F	
D9CL-14F	Motor Frame Size □85 mm and □90 mm, or smaller

Installing of the Clean Damper

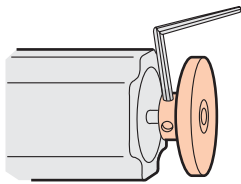

Dimensions (Unit = mm)

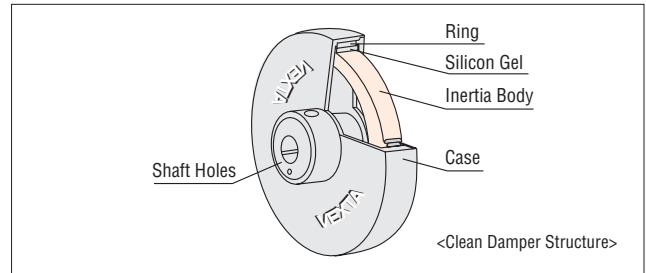
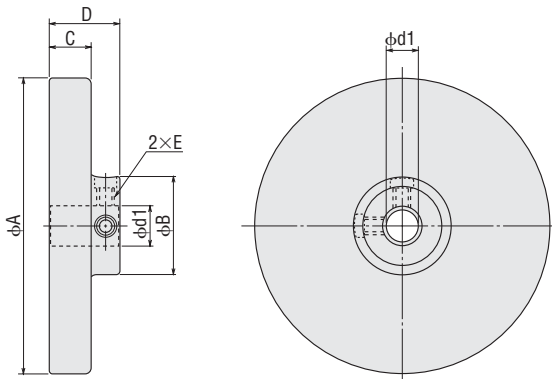

Point the mounting screws of the clean damper toward the motor case, fasten to the shaft and tighten the damper's mounting screws (two places) with an allen wrench to secure it to the shaft.

Model	D4CL-5.0F	D6CL-6.3F	D6CL-8.0F	D9CL-14F
Tightening Torque N·m	0.4		1.5	

Notes:

- There are mounting screws with hexagonal holes in two damper locations, so tighten them both before running the motor.
- The damper rotates at the same speed as the motor shaft, so do not touch it while the motor is running.

Model	φd1	φA	φB	C	D	E
D4CL-5.0F	5 ^{+0.018} ₀	φ36±0.5	φ13±0.5	9±0.3	15±0.5	M3
D6CL-6.3F	6.35 ^{+0.022} ₀	φ44.5±0.5	φ20±0.5	15±0.3	22±0.5	M4
D6CL-8.0F	8 ^{+0.022} ₀					
D9CL-14F	14 ^{+0.027} ₀	φ79.5±0.5	φ26±0.5	11±0.3	19±0.5	M4

High-Efficiency	□28 mm
High-Torque	□35 mm
Standard	□42 mm
IP54 Cable Type	□50 mm
IP65 Terminal Box	□56.4 mm
High-Resolution	□60 mm
PL Geared	□85 mm
TH Geared	□85 mm
SH Geared	□90 mm
2-Phase	Motor & Driver Package
5-Phase	Motor & Driver Package
Lead Wire/ Connector	Accessories
Coupling	
Damper	
Mounting Bracket	

● Clean Damper Selection Table

Model	Inertia kg·m ²	Mass g	Applicable Product
D4CL-5.0F	34×10 ⁻⁷	24	PKE244B, PKE244DB PK22□PB, PK22□PDB PK23□PB, PK23□PDB PK24□PB, PK24□PDB PK24□-01B, PK24□-02B, PK24□-03B, PK24□DB PK24□M-01B, PK24□M-02B, PK24□M-03B PK223PB-SG■ PK243B1-SG■ PK243B1-T■, PK243DB-T■ PK244PDB-P■
D6CL-6.3F	140×10 ⁻⁷	62	PK25□-02B PK26□PB, PK26□PDB PK26□-01B, PK26□-02B, PK26□-03B, PK26□-E2.0B PK26□DB PK26□M-01B, PK26□M-02B, PK26□M-03B, PK26□M-E2.0B PK264BE-SG■ PK264B2-T■, PK264DB-T■ PK26□PDB-P■
D6CL-8.0F	140×10 ⁻⁷	61	PK26□JB, PK26□JDB
D9CL-14F	870×10 ⁻⁷	105	PK29□-E4.5B, PK2913-E4.0B, PK29□DB PK296BE-SG■

● Ambient Temperature: -20 to +80°C

● Enter the motor case length in the box (□) within the model name.

Enter the gear ratio in the box (■) within the model name.

Motor Mounting Brackets (RoHS)

Mounting brackets are convenient for installation and securing a stepping motor and geared stepping motor.



Product Line

◇ High-Efficiency Type, High-Torque Type, Standard Type, High-Resolution Type

Model	Applicable Product
PAFOP PALOP	PKE244□, PKE244D□
	PK24□P□, PK24□PD□
	PK24□-01□, PK24□-02□, PK24□-03□, PK24□D□
	PK24□M-01□, PK24□M-02□, PK24□M-03□
PAL2P-2	PK26□P□, PK26□PD□, PK26□J□, PK26□JD□
	PK26□-01□, PK26□-02□, PK26□-03□, PK26□-E2.0□
	PK26□D□, PK26□DW, PK26□DAT, PK26□D1T
	PK26□M-01□, PK26□M-02□, PK26□M-03□, PK26□M-E2.0□
PAL4P-2	PK29□-E4.5□, PK2913-E4.0□
	PK29□D□, PK29□DW, PK29□EAT, PK29□DT

● Material: Aluminum alloy

● Enter the motor case length in the box (□) within the model name.

Enter **A** (single shaft) or **B** (double shaft) in the box (□) within the model name.

◇ Geared Type

Model	Applicable Product
SOLOA	PK243□1-SG□
SOLOB	PK243□1-T□, PK243D□-T□, PK244PD□-P□
SOL2A	PK264□E-SG□, PK264□2-T□, PK264D□-T□
SOL2B	PK266PD□-P□, PK264PD□-P□
SOL5A	PK296□E-SG□

● Material: Aluminum alloy

● Enter **A** (single shaft) or **B** (double shaft) in the box (□) within the model name.

Enter the gear ratio in the box (■) within the model name.

Motor Mounting Direction

The motor cable comes out at right angles to the motor. Orientate the motor so that the cable faces either upwards or sideways.

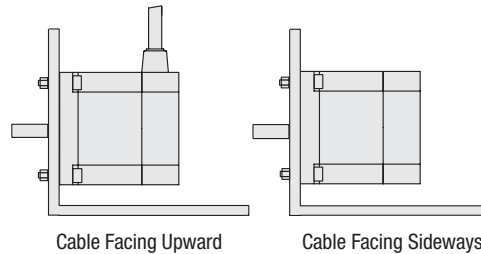

Cable Facing Upward

Cable Facing Sideways

Mounting the Motor

① PAL2P-2, PAL4P-2

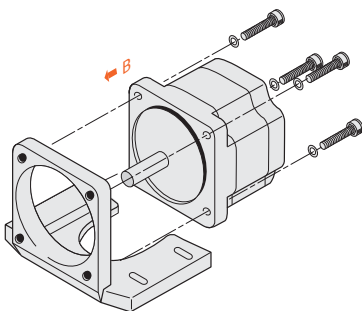

- Use the screws to secure the motor to the mounting bracket.
- Attach the motor from the direction shown by the arrow (B).

② PALOP, SOLOA, SOLOB, SOL2A, SOL2B, SOL5A

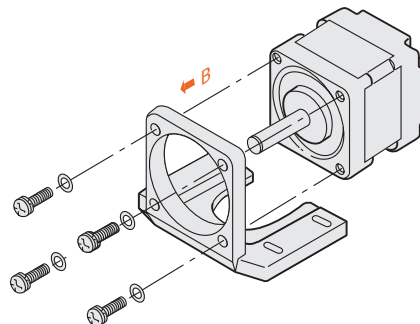

- Use the screws to secure the motor to the mounting bracket.
- Attach the motor from the direction shown by the arrow (B).

③ PAFOP

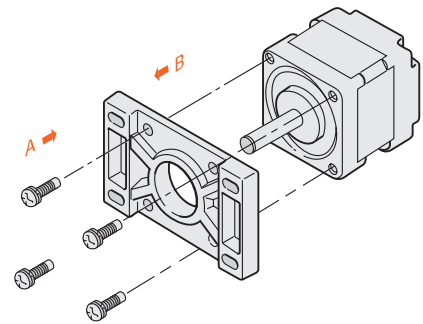

- Use the screws to secure the motor to the mounting bracket.
- Attach the motor from the direction shown by either arrow (A) or arrow (B).

High-Efficiency	□28 mm
High-Torque	□35 mm
Standard	□42 mm
Cable Type	IP54
Terminal Box	□50 mm
High-Resolution	□56.4 mm
PL Geared	□60 mm
TH Geared	□85 mm
SH Geared	□90 mm
2-Phase	Motor & Driver Package
5-Phase	Motor & Driver Package
Lead Wire/ Connector	Accessories
Coupling	Accessories
Damper	Accessories
Mounting Bracket	Accessories

● Dimensions (Unit = mm)

PALOP

Mass: 35 g

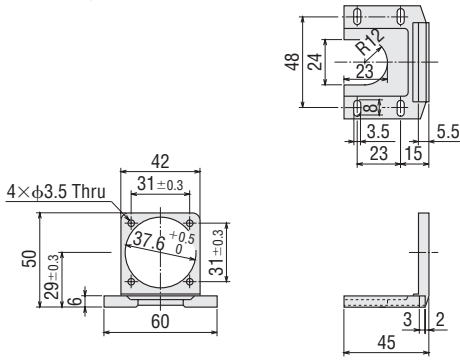

- Screws (Included)
- M3 Length 10 mm ... 4 Pieces

PAFOP

Mass: 30 g

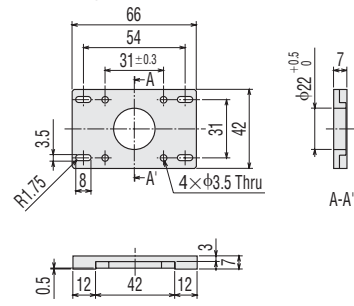

- Screws (Included)
- M3 Length 7 mm ... 4 Pieces

PAL2P-2

Mass: 110 g

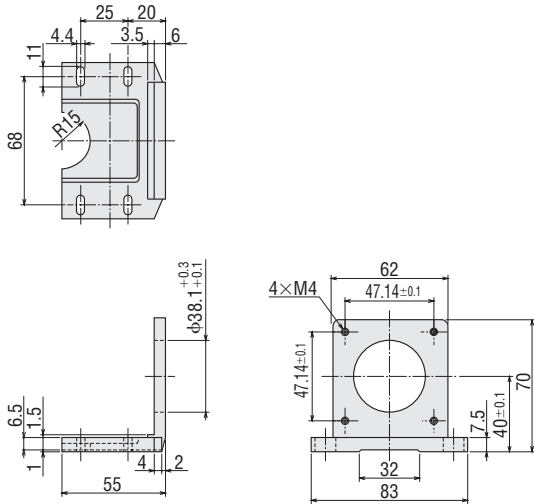

- Screws (Included)
- M4 Length 12 mm ... 4 Pieces

PAL4P-2

Mass: 250 g

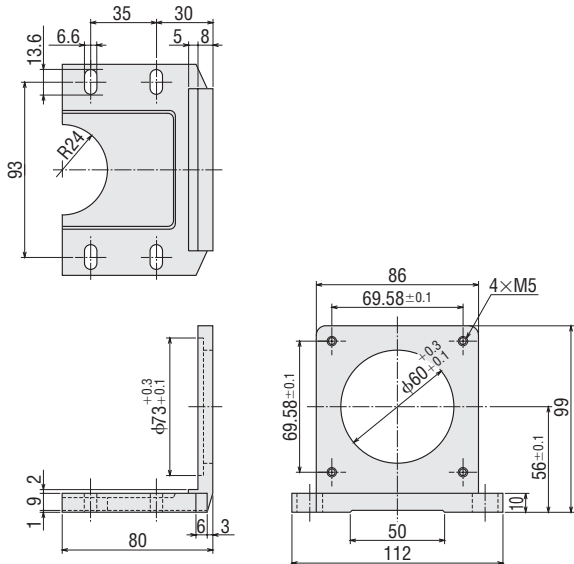

- Screws (Included)
- M5 Length 16 mm ... 4 Pieces

SOL0A

Mass: 85 g

SOL0B

Mass: 85 g

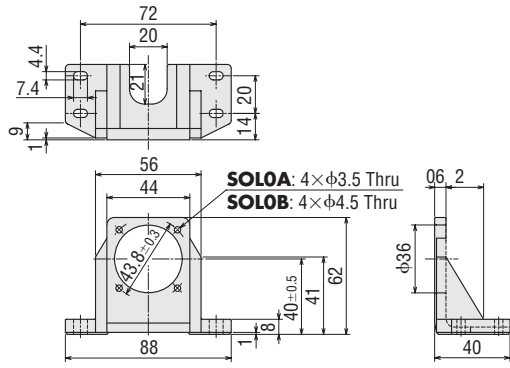

SOL2A

Mass: 120 g

SOL2B

Mass: 120 g

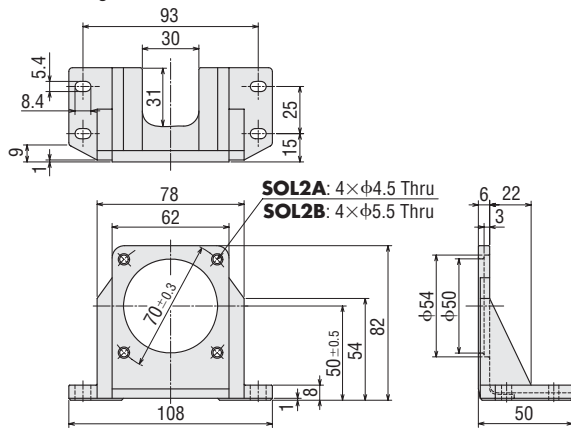

● Screws (Included)

M4 Length 12 mm ... 4 Pieces (**SOL2A**)

M5 Length 15 mm ... 4 Pieces (**SOL2B**)

SOL5A

Mass: 270 g

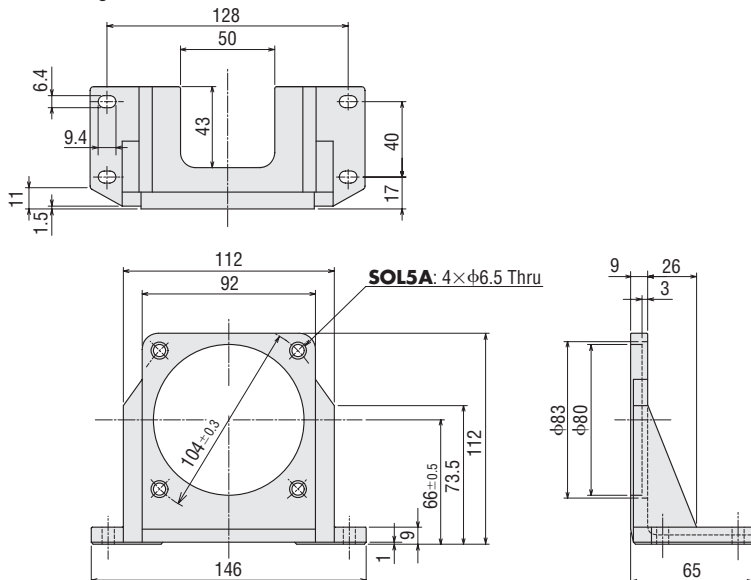

High-Efficiency	High-Torque	Standard	IP54 Cable Type	IP55 Terminal Box	High-Resolution	PL Geared	TH Geared	SH Geared	Motor & Driver Package	Accessories
<input type="checkbox"/> 28 mm	<input type="checkbox"/> 35 mm	<input type="checkbox"/> 42 mm	<input type="checkbox"/> 50 mm	<input type="checkbox"/> 56.4 mm	<input type="checkbox"/> 60 mm	<input type="checkbox"/> 85 mm	<input type="checkbox"/> 90 mm	2-Phase	5-Phase	
								Lead Wire/ Connector	Coupling	
										Mounting Bracket

This product is manufactured at a plant certified with the international standards **ISO 9001** (for quality assurance) and **ISO 14001** (for systems of environmental management).

Specifications are subject to change without notice.
This catalogue was published in August, 2009.

Orientalmotor

ORIENTAL MOTOR (EUROPA) GmbH

www.orientalmotor.de

European Headquarters and Düsseldorf Office

Schiesstraße 74
40549 Düsseldorf, Germany
Tel: 0211-5206700 Fax: 0211-52067099

Munich Office

Carl-von-Linde-Straße 42
85716 Unterschleißheim, Germany
Tel: 089-3181225-00 Fax: 089-3181225-25

Hamburg Office

Meckelfelder Weg 2
21079 Hamburg, Germany
Tel: 040-76910443 Fax: 040-76910445

Jena Office

Wildenbruchstraße 15
07745 Jena, Germany
Tel: 03641-675280 Fax: 03641-675288

Stuttgart Office

Tel: 07335-924853 Fax: 07335-924854

ORIENTAL MOTOR (UK) LTD.

www.oriental-motor.co.uk

Unit 5 Faraday Office Park,
Rankine Road, Basingstoke,
Hampshire RG24 8AH U.K.
Tel: 01256-347090 Fax: 01256-347099

ORIENTAL MOTOR (FRANCE) SARL

www.orientalmotor.fr

France Headquarters

32, Avenue de l'île Saint Martin
92737 Nanterre Cedex, France
Tel: 01 47 86 97 50 Fax: 01 47 82 45 16

Lyon Office

10, Allée des Sorbiers
69673 Bron Cedex, France
Tel: 04 78 41 15 02 Fax: 04 78 41 15 90

ORIENTAL MOTOR ITALIA s.r.l.

www.orientalmotor.it

Italy Headquarters

Via A. De Gasperi, 85
20017 Mazzo di Rho (MI), Italy
Tel: 02-93906346 Fax: 02-93906348

Bologna Office

Via mori, 6
40054 Prunaro di Budrio (BO), Italy
Tel: 051-6931249 Fax: 051-6929266

Verona Office

Piazza Roma, 3A
37066 Sommacampagna (VR), Italy
Tel: 045-8961049 Fax: 045-8971978

ORIENTAL MOTOR CO., LTD.

www.orientalmotor.co.jp

Headquarters

16-17, Ueno 6-chome
Taito-ku, Tokyo 110-8536, Japan
Tel: (03)3835-0684 Fax: (03)3835-1890

Customer Center (Support in German & English)

00800 22 55 66 22*
C A L L O M C C

Mon-Thu: 08:00-17:30 CET Friday: 08:00-16:00 CET
* Free Call Europe

tech@orientalmotor.de

For more information please contact:

©Copyright ORIENTAL MOTOR CO., LTD. 2009



This printed material uses ECF (Elementary Chlorine Free) paper and soy inks. This combination is environmentally friendly.

Printed in Japan 09V 5K 24204Z V-007E

Buy: www.ValinOnline.com | Phone 844-385-3099 | Email: CustomerService@valin.com