

# Industrial Ethernet Cables

## XS5/XS6

### Cables and Connectors for EtherCAT® and Other Industrial Ethernet Networks

**CAT6a Ethernet patch cables**

- For in-cabinet use
- LSZH with standard RJ45 plugs

**CAT5e Ethernet patch cables**

- For out-of-cabinet use
- PUR with standard RJ45 plugs
- PVC with rugged RJ45 plugs
- PVC with M12 SmartClick plugs



### Connection Examples

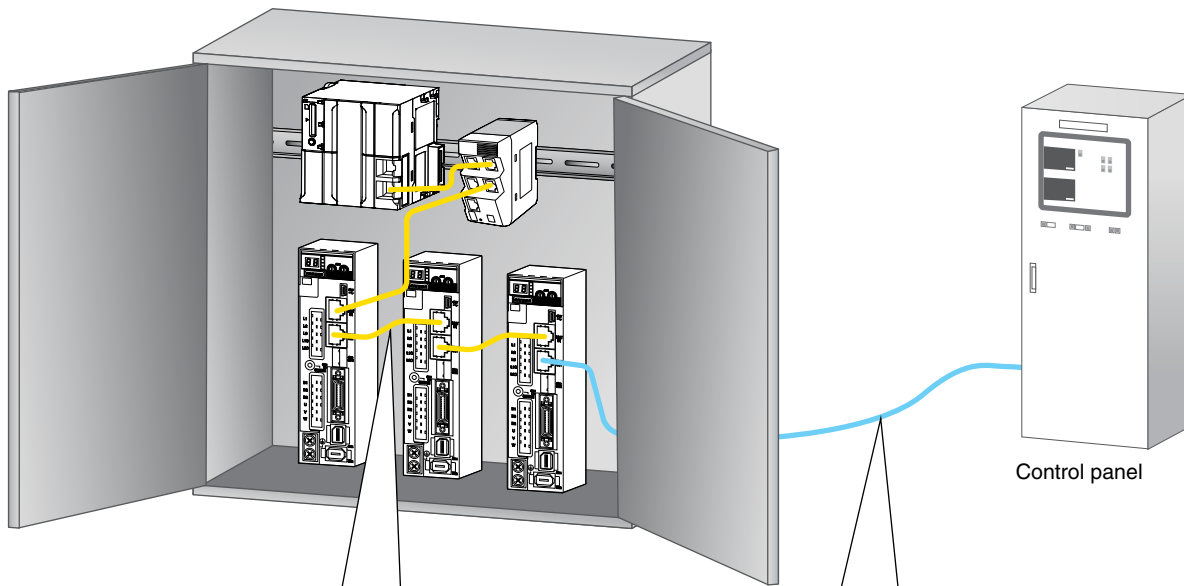

**Ideal for in-cabinet**  
XS6W-6LSZH

Standard Connectors

**Ideal for out-of-cabinet**

XS6W-5PUR	XS5	XS6
Standard Connectors	Rugged Connectors	Rugged Assembly Connectors
XS5		
M12 Connectors		

## ■ Features

### Cables with Standard RJ45 Connectors

Refer to page 4 for details.

- The lineup features LSZH cables\* for in-panel wiring and PUR cables for wiring outside of panels.
- The Standard RJ45 Connectors reduce cable routing space.
  - Outer diameter: 5.8 mm
  - 4-pair AWG27 (LSZH) or AWG26 (PUR)
- Cable colors include blue, yellow, or green.
- LSZH cables are available in 12 lengths from 0.2 to 20 m and PUR cables are available in 10 lengths from 0.5 to 20 m.
- Double-shielded cables with overall braiding and individual foil shield on each wire pair to reduce EMC interference in industrial environments.

\* Low-smoke zero-halogen cables.

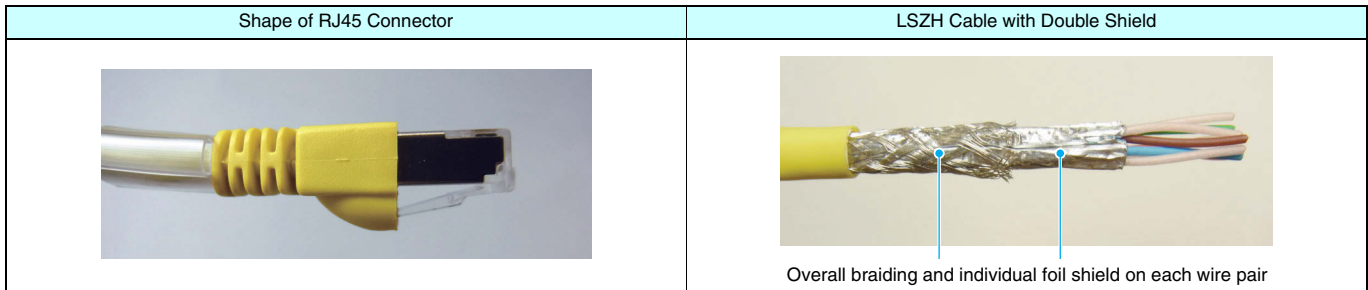

### Cables with Rugged RJ45 Connectors

Refer to page 7 for details.

- Tough latches and RJ45 connectors with strong cable holding strength are used to enable connections outside of control panels.
- Quad AWG22 cable with PVC cover of 6.5 mm outer diameter.
- Double-shielded cables with overall braiding and individual foil shield to reduce EMC interference in industrial environments.

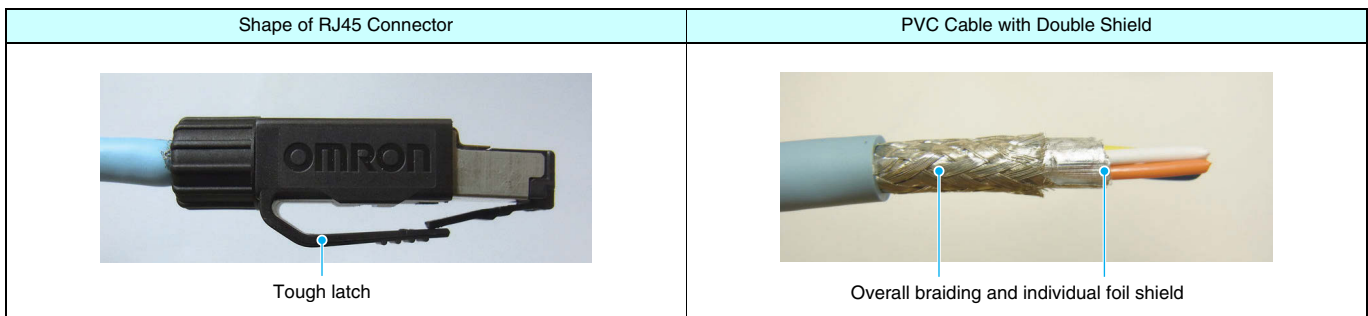

### Assembly Connectors

You can easily assemble Ethernet cables onsite without crimping tools or other special tools.

Refer to page 14 for the assembly procedure.



### ● Cable Extension Length

#### Standard Connectors (RJ45 Connectors)

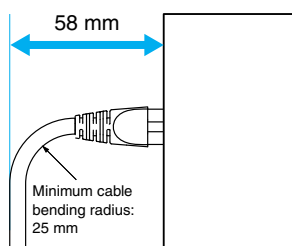

#### Rugged Connectors (RJ45 Connectors)

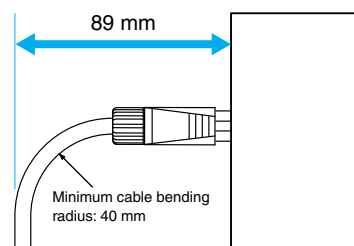

## Cables with M12 Connectors

Refer to page 7 for details.

- Resistance to harsh environments with IP67 protection.
- SmartClick Connectors that provide one-step (1/8th turn) connection are used (compatible with standard M12 screw connectors).
- A wide range of variations, such as cables with right-angle connectors and PCB connectors.
- Cables with sockets and robot cables were added to the series.

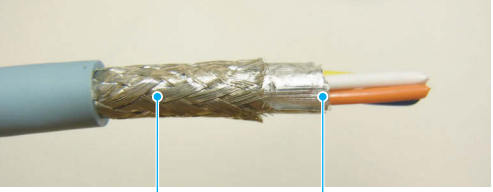
Shape of M12 Connector	PVC Cable with Double Shield
 <p style="text-align: center;">Shield structure</p>	 <p style="text-align: center;">Overall braiding and individual foil shield</p>

### Shield Effectiveness Data for Rugged RJ45 Connectors and Waterproof M12 Connectors

The following data is the results of OMRON testing. Shield effectiveness may vary for your environment and application conditions.

#### ● Comparison of Shield Effectiveness with Product without a Double Shield

The following table shows the differences with a structure without a double shield. Higher numeric values show greater shield effectiveness.

Shield structure	Frequency (MHz)				
	0.5	1	5	10	30
Product with single shield	53 dB	49 dB	35 dB	25 dB	17 dB
Product with a double shield (XS5□-T, Category 5E)	61 dB	58 dB	43 dB	31 dB	27 dB

- SmartClick is registered trademark of OMRON Corporation.
- EtherCAT® is a registered trademark and patented technology, licensed by Beckhoff Automation GmbH, Germany.

## Cables with Standard RJ45 Connectors

## ■ Model Number Legend

Use this legend when determining the product specifications from the model number. Choose from the model numbers listed in *Ordering Information* when ordering.

**XS6W-**□ □□□□ **8 SS** □□□□ **CM-**□

①      ②      ③ ④      ⑤      ⑥

① **Transmission Characteristics**

5: Category 5

6: Category 6A

② **Sheath Material**

LSZH: LSZH

PUR: PUR

③ **Number of Pins**

8: 8 pins

④ **Cable Attachment Direction**

SS: Straight/Straight

⑤ **Cable Length\***

20: 0.2 m

30: 0.3 m

50: 0.5 m

100: 1 m

150: 1.5 m

200: 2 m

300: 3 m

500: 5 m

750: 7.5 m

1000: 10 m

1500: 15 m

2000: 20 m

⑥ **Sheath Color**



B: Blue

Y: Yellow

G: Green

\* PUR cables are not available for 0.2-m and 0.3-m cables.

## Ordering Information

Appearance	Type	Category	Cable sheath material	Cable color	Cable length (m)	Model
	Cable with Connectors on Both Ends (RJ45/RJ45)	Cat.6a	LSZH	Blue	0.2	XS6W-6LSZH8SS20CM-B
					0.3	XS6W-6LSZH8SS30CM-B
					0.5	XS6W-6LSZH8SS50CM-B
					1	XS6W-6LSZH8SS100CM-B
					1.5	XS6W-6LSZH8SS150CM-B
					2	XS6W-6LSZH8SS200CM-B
					3	XS6W-6LSZH8SS300CM-B
					5	XS6W-6LSZH8SS500CM-B
					7.5	XS6W-6LSZH8SS750CM-B
					10	XS6W-6LSZH8SS1000CM-B
					15	XS6W-6LSZH8SS1500CM-B
20				XS6W-6LSZH8SS2000CM-B		
Yellow				0.2	XS6W-6LSZH8SS20CM-Y	
				0.3	XS6W-6LSZH8SS30CM-Y	
				0.5	XS6W-6LSZH8SS50CM-Y	
				1	XS6W-6LSZH8SS100CM-Y	
				1.5	XS6W-6LSZH8SS150CM-Y	
				2	XS6W-6LSZH8SS200CM-Y	
				3	XS6W-6LSZH8SS300CM-Y	
				5	XS6W-6LSZH8SS500CM-Y	
		7.5	XS6W-6LSZH8SS750CM-Y			
		10	XS6W-6LSZH8SS1000CM-Y			
	15	XS6W-6LSZH8SS1500CM-Y				
20	XS6W-6LSZH8SS2000CM-Y					
	Green	Cat.6a	LSZH	Green	0.2	XS6W-6LSZH8SS20CM-G
					0.3	XS6W-6LSZH8SS30CM-G
					0.5	XS6W-6LSZH8SS50CM-G
					1	XS6W-6LSZH8SS100CM-G
					1.5	XS6W-6LSZH8SS150CM-G
					2	XS6W-6LSZH8SS200CM-G
					3	XS6W-6LSZH8SS300CM-G
					5	XS6W-6LSZH8SS500CM-G
					7.5	XS6W-6LSZH8SS750CM-G
					10	XS6W-6LSZH8SS1000CM-G
					15	XS6W-6LSZH8SS1500CM-G
20	XS6W-6LSZH8SS2000CM-G					
	Green	Cat.5	PUR	Green	0.5	XS6W-5PUR8SS50CM-G
					1	XS6W-5PUR8SS100CM-G
					1.5	XS6W-5PUR8SS150CM-G
					2	XS6W-5PUR8SS200CM-G
					3	XS6W-5PUR8SS300CM-G
					5	XS6W-5PUR8SS500CM-G
					7.5	XS6W-5PUR8SS750CM-G
					10	XS6W-5PUR8SS1000CM-G
					15	XS6W-5PUR8SS1500CM-G
20	XS6W-5PUR8SS2000CM-G					

## Specifications

Item	Type	Cable with Connectors on Both Ends (RJ45/RJ45)/LSZH	Cable with Connectors on Both Ends (RJ45/RJ45)/PUR
	Model	XS6W-6LSZH8SS□□□□CM-□	XS6W-5PUR8SS□□□□CM-G
Rated current		1 A (at 50°C)	
Withstand voltage		1,000 VDC for 60 s (leakage current: 1 mA max.)	
Ambient operating temperature		-20 to 60°C	-40 to 85°C
Ambient storage temperature		-20 to 60°C	-40 to 85°C
Ambient installation temperature		0 to 50°C	-10 to 60°C
Protective structure		IP20	

## Materials and Finish

### Connectors

Item	Type	Cable with Connectors on Both Ends (RJ45/RJ45)/LSZH	Cable with Connectors on Both Ends (RJ45/RJ45)/PUR
	Model	XS6W-6LSZH8SS□□□□CM-□	XS6W-5PUR8SS□□□□CM-G
Connector housing		PC resin (UL94V-0)/transparent	
Contacts		Phosphor bronze/nickel base, gold plated (0.8 μm)	
Shield		Brass/nickel plated	
Cover (structured to prevent the tab from breaking)		LSZH: Blue, yellow, or green	PUR: Green
Marking tube		PVC resin (UL94V-0)/transparent	

### Cables

Item	Type	Cable with Connectors on Both Ends (RJ45/RJ45)/LSZH	Cable with Connectors on Both Ends (RJ45/RJ45)/PUR
	Model	XS6W-6LSZH8SS□□□□CM-□	XS6W-5PUR8SS□□□□CM-G
Compliant standard		IEC 60332-1 /UL1581 FT2	
Number of cores/gauge		4 × 2 × AWG27 0.1 mm <sup>2</sup>	
Outer diameter*1		5.8 mm	
Sheath color*2		Blue, yellow, or green	Green
Sheath material		LSZH	PUR
Shield structure		Double shield S/FTP	Double shield SF/UTP

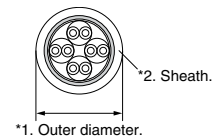

## Dimensions

(Unit: mm)

### Cable with Connectors on Both Ends (RJ45/RJ45)

XS6W-6LSZH8SS□□□□CM-□

XS6W-5PUR8SS□□□□CM-G

#### Wiring

RJ45	1	RJ45	1
	2		2
	3		3
	4		4
	5		5
	6		6
	7		7
	8		8
Shield		Shield	

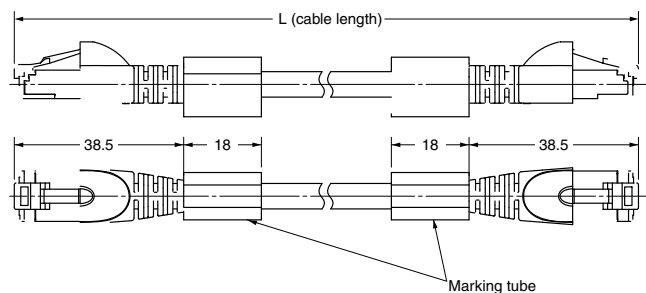
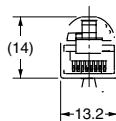

Note. External dimensions are the same for all cable materials.

## Cables with Rugged RJ45 Connectors and Cables with M12 Connectors

### Model Number Legend

Use this legend when determining the product specifications from the model number. Choose from the model numbers listed in *Ordering Information* when ordering.

#### ● Cable with Connectors

**XS5**□-**T** **4** **2** □-□**M**□-□□

① ② ③ ④ ⑤ ⑥ ⑦ ⑧

##### ① Connector Shape

H: Cable with plug on one end

W: Cable with connectors on both ends

##### ② Type

T: Ethernet (mating part: M12 D coding)

##### ③ Number of Pins

4: 4 pins

##### ④ Contact Plating Specification

2: Gold plating, 0.4 μm

##### ⑤ Cable Attachment Direction (M12 Connectors)

1: Straight

2: Right angle

##### ⑥ Cable Length

A: 0.3 m

B: 0.5 m

C: 1 m

D: 2 m

E: 3 m

G: 5 m

J: 10 m

K: 15 m

##### ⑦ Connector Shape

0: M12 plug on one end

1: Connectors on both ends: M12 socket/M12 plug

2: Connectors on both ends: M12 plug/M12 plug

C: Connectors on both ends: M12 plug/RJ45 plug

D: Connectors on both ends: RJ45 plug/RJ45 plug

E: Connectors on both ends: M12 socket/RJ45 plug

##### ⑧ Cable Specification

K: Standard cable

KR: Robot cable

#### ● RJ45 Assembly Connectors

**XS6G-T** **4** **2** **1-1**

① ② ③ ④ ⑤

##### ① Type

T: Ethernet

##### ② Number of Pins

4: 4 pins

##### ③ Contact Plating Specification

2: Gold plating, 0.4 μm

##### ④ Cable Attachment Direction

1: Straight

##### ⑤ Degree of Protection

1: IP20

#### ● M12 Connectors for Panel Mounting

**XS5P-T** **4** **2** □-□

① ② ③ ④ ⑤

##### ① Type

T: Ethernet (mating part: M12 D coding)

##### ② Number of Pins

4: 4 pins

##### ③ Plating Specification

2: Gold plating, 0.4 μm

##### ④ Mounting Method

6: Rear locking

7: Front locking

##### ⑤ Terminal Shape

1: DIP terminalst

5: Cable with loose wires (0.5 m)

## Ordering Information

Appearance	Cable type	Type	Cable length (m)	Model
	Standard Cables	Cable with Plug on One End (M12 Straight)	0.5	XS5H-T421-BM0-K
			1	XS5H-T421-CM0-K
			2	XS5H-T421-DM0-K
			3	XS5H-T421-EM0-K
			5	XS5H-T421-GM0-K
			10	XS5H-T421-JM0-K
		Cable with Plugs on Both Ends (M12 Straight/M12 Straight)	0.5	XS5W-T421-BM2-K
			1	XS5W-T421-CM2-K
			2	XS5W-T421-DM2-K
			3	XS5W-T421-EM2-K
			5	XS5W-T421-GM2-K
			10	XS5W-T421-JM2-K
		Cable with Plugs on Both Ends (M12 Straight/RJ45)	0.3	XS5W-T421-AMC-K
			0.5	XS5W-T421-BMC-K
			1	XS5W-T421-CMC-K
			2	XS5W-T421-DMC-K
			3	XS5W-T421-EMC-K
			5	XS5W-T421-GMC-K
	Cable with Plug on One End (M12 Right-angle)	0.5	XS5H-T422-BM0-K	
		1	XS5H-T422-CM0-K	
		2	XS5H-T422-DM0-K	
		3	XS5H-T422-EM0-K	
		5	XS5H-T422-GM0-K	
		10	XS5H-T422-JM0-K	
	Cable with Plugs on Both Ends (M12 Right-angle/M12 Right-angle)	0.5	XS5W-T422-BM2-K	
		1	XS5W-T422-CM2-K	
		2	XS5W-T422-DM2-K	
		3	XS5W-T422-EM2-K	
		5	XS5W-T422-GM2-K	
		10	XS5W-T422-JM2-K	
	Cable with Plugs on Both Ends (M12 Right-angle/RJ45)	0.3	XS5W-T422-AMC-K	
		0.5	XS5W-T422-BMC-K	
		1	XS5W-T422-CMC-K	
		2	XS5W-T422-DMC-K	
		3	XS5W-T422-EMC-K	
		5	XS5W-T422-GMC-K	
	Cable with Plugs on Both Ends (RJ45/RJ45)	0.3	XS5W-T421-AMD-K	
		0.5	XS5W-T421-BMD-K	
		1	XS5W-T421-CMD-K	
		2	XS5W-T421-DMD-K	
		3	XS5W-T421-EMD-K	
		5	XS5W-T421-GMD-K	
	Cable with Plug on One End and Socket on Other End (M12 Straight/M12 Straight)	0.5	XS5W-T421-BM1-K	
		1	XS5W-T421-CM1-K	
		2	XS5W-T421-DM1-K	
		3	XS5W-T421-EM1-K	
		5	XS5W-T421-GM1-K	
		10	XS5W-T421-JM1-K	
	Cable with Plug on One End and Socket on Other End (M12 Straight/RJ45)	0.5	XS5W-T421-BME-K	
		1	XS5W-T421-CME-K	
		2	XS5W-T421-DME-K	
		3	XS5W-T421-EME-K	
		5	XS5W-T421-GME-K	
		10	XS5W-T421-JME-K	
			15	XS5W-T421-KME-K



Appearance	Cable type	Type	Cable length (m)	Model		
	Robot Cables	Cable with Plug on One End and Socket on Other End (M12 Straight/M12 Straight)	0.5	XS5W-T421-BM1-KR		
			1	XS5W-T421-CM1-KR		
			2	XS5W-T421-DM1-KR		
			3	XS5W-T421-EM1-KR		
			5	XS5W-T421-GM1-KR		
			10	XS5W-T421-JM1-KR		
			15	XS5W-T421-KM1-KR		
			Cable with Plugs on Both Ends (M12 Straight/M12 Straight)	0.5	XS5W-T421-BM2-KR	
				1	XS5W-T421-CM2-KR	
				2	XS5W-T421-DM2-KR	
				3	XS5W-T421-EM2-KR	
				5	XS5W-T421-GM2-KR	
				10	XS5W-T421-JM2-KR	
			Cable with Plugs on Both Ends (M12 Straight/RJ45)	0.5	XS5W-T421-BMC-KR	
				1	XS5W-T421-CMC-KR	
2	XS5W-T421-DMC-KR					
3	XS5W-T421-EMC-KR					
5	XS5W-T421-GMC-KR					
10	XS5W-T421-JMC-KR					
Cable with Plugs on Both Ends (RJ45/RJ45)	0.5	XS5W-T421-BMD-KR				
	1	XS5W-T421-CMD-KR				
	2	XS5W-T421-DMD-KR				
	3	XS5W-T421-EMD-KR				
	5	XS5W-T421-GMD-KR				
	10	XS5W-T421-JMD-KR				
	Standard Cables	RJ45 Assembly Connector	---	XS6G-T421-1		
			M12 Connector for Panel Mounting	Rear locking	0.5	XS5P-T426-5
				Front locking	0.5	XS5P-T427-5
	M12 Panel-mounting PCB Straight Terminals	---	XS5P-T426-1			

### ● Cable Bending Data for Robot Cables (XS5W-T421-□M□-KR)

The following data is the results of OMRON testing for cable bending test conditions. The number of bends may vary for your environment and application conditions.

#### Cableveyor Test

Number of bends: 20 million min.

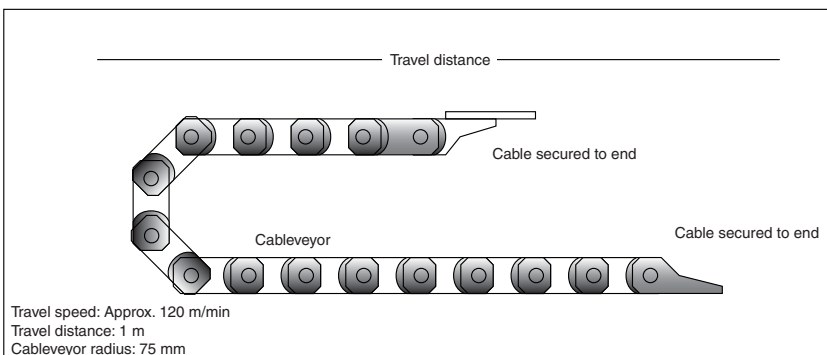

#### 90° Bending Test

Number of bends: 6 million min.

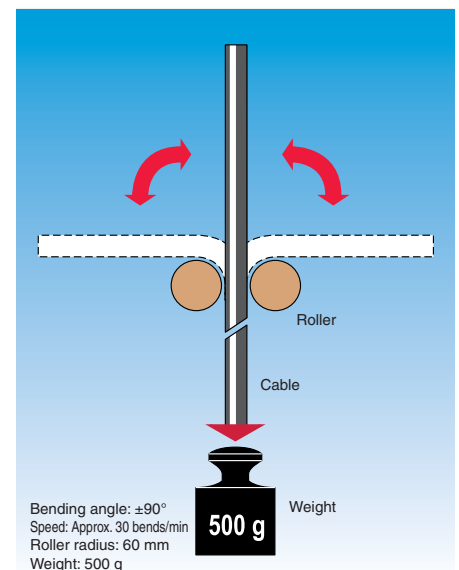

## Specifications

Type	Cable with Plug on One End (M12)	Cable with Plugs on Both Ends (M12/M12)	Cable with Plug on One End and Socket on Other End (M12/M12)	Cable with Plugs on Both Ends (M12/RJ45)	Cable with Plug on One End and Socket on Other End (M12/RJ45)	Cable with Plugs on Both Ends (RJ45/RJ45)	RJ45 Assembly Connector	M12 Connector for Panel Mounting	M12 Panel-mounting PCB Straight Terminals
Item	Model	XS5H -T42□-□M0-K	XS5W -T42□-□M2-K, -KR	XS5W -T42□-□M1-K, -KR	XS5W -T42□-□MC-K, -KR	XS5W -T421-□ME-K	XS5W -T421-□MD-K, -KR	XS6G -T421-1	XS5P-T42□-5  XS5P -T426-1
Rated current	3 A			2.5 A			4 A		
Rated voltage	30 V							125 VDC	
Contact resistance	40 mΩ max.								
Insulation resistance	1,000 MΩ min.			500 MΩ min.				1,000 MΩ min.	
Withstand voltage	1,000 VAC for 60 s (leakage current: 1 mA max.)							1,500 VAC for 60 s (leakage current: 1 mA max.)	
Ambient operating temperature	-25 to 70°C								
Ambient storage temperature	-25 to 70°C								
Protective structure	M12: IEC IP67, RJ45: IEC IP20								

## Materials and Finish

### Connectors

Item	Model	M12			RJ45
		XS5H and XS5W	XS5P-T42□-5	XS5P-T426-1	XS5W and XS6G
Contact blocks	PBT resin (UL94V-0)/light gray			PA resin (UL94V-0)/black	PA resin (UL94V-0)/black
Contacts	Phosphor bronze/nickel base, gold plated (0.4 μm)			Brass/nickel base, gold plated (0.4 μm)	Phosphor bronze/nickel base, gold plated (1.4 μm)
Anchors	Zinc diecast/nickel plating				---
Anchors (tabs)	SUS	---			---
Cover	Straight connector: Soft PBT resin (UL94V-0)/black Right-angle connector: TPC resin/black		---		---
Sealing resin	---	Epoxy resin	---		
O-rings	Rubber				---
Grounding fixture	---			Phosphor bronze/nickel base, tin plated (2.0 μm)	---
Anchor cover	---			SUS	---
Nuts	---		Brass/nickel plated		---

### Cables

Item	Model	Standard Cables	Robot Cables
Compliant standard	UL CM		
Category	Category 5e		
Number of cores/gauge	4 × AWG22 0.3 mm <sup>2</sup> (7/0.26)		4 × AWG22 0.3 mm <sup>2</sup> (7/24/0.05)
Outer diameter*1	6.5 dia.		
Sheath color*2	Light blue		
Sheath material	PVC		
Shield structure	Double shield SF/UTP		

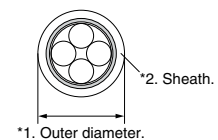

Note. For the XS5H and XS5W, cables are available only with connectors attached.

## ■ Dimensions

(Unit: mm)

### ● Cable with Plug on One End (M12 Straight) XS5H-T421-□M0-K

#### Wiring

Terminal No.	Color
1	Yellow
2	White
3	Orange
4	Blue

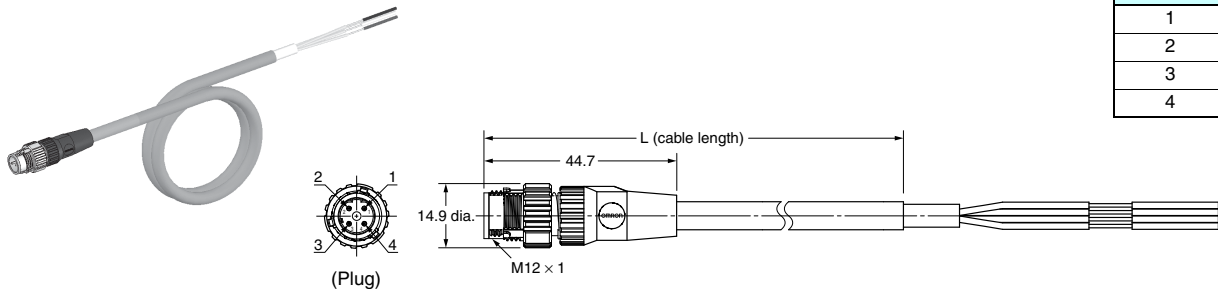

### ● Cable with Plugs on Both End (M12 Straight/M12 Straight) XS5W-T421-□M2-K XS5W-T421-□M2-KR

#### Wiring

M12 straight	M12 straight
1	1
2	2
3	3
4	4
Shield	Shield

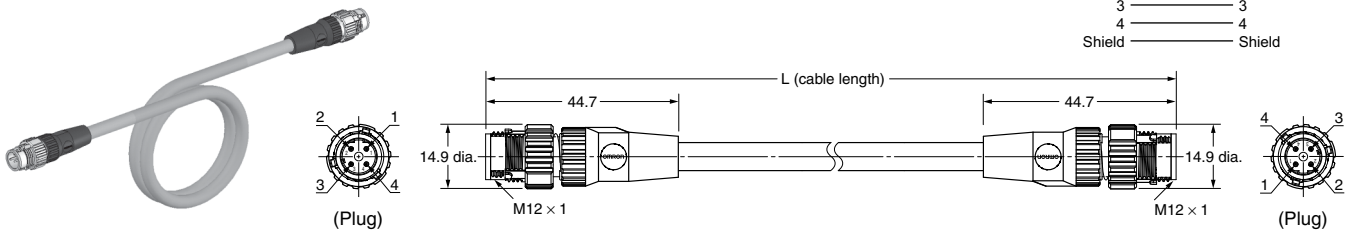

### ● Cable with Plugs on Both Ends (M12 Straight/RJ45) XS5W-T421-□MC-K XS5W-T421-□MC-KR

#### Wiring

M12 straight	RJ45
1	1
2	3
3	2
4	6
Shield	Shield

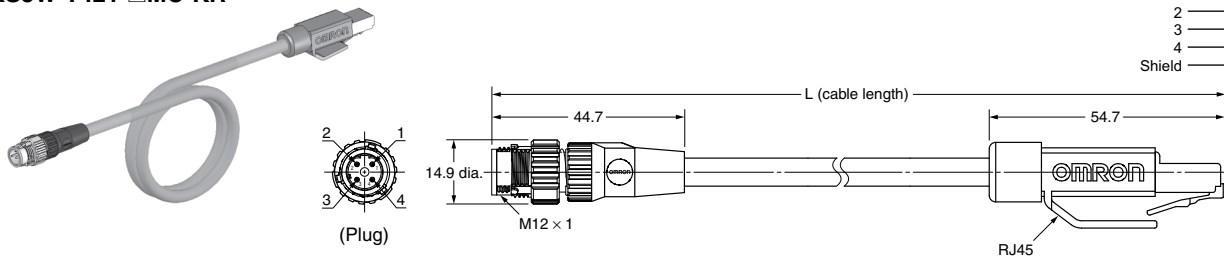

### ● Cable with Plug on One End and Socket on Other End (M12 Straight/M12 Straight) XS5W-T421-□M1-K XS5W-T421-□M1-KR

#### Wiring

M12 straight	M12 straight
1	1
2	2
3	3
4	4
Shield	Shield

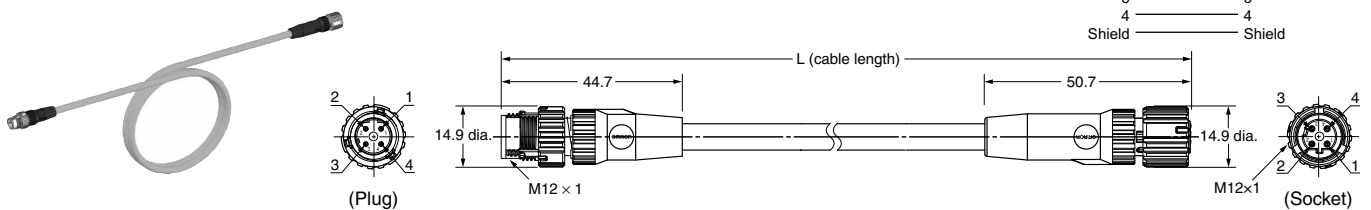

### ● Cable with Plug on One End and Socket on Other End (M12 Straight/RJ45) XS5W-T421-□ME-K

#### Wiring

M12 straight	RJ45
1	1
2	3
3	2
4	6
Shield	Shield

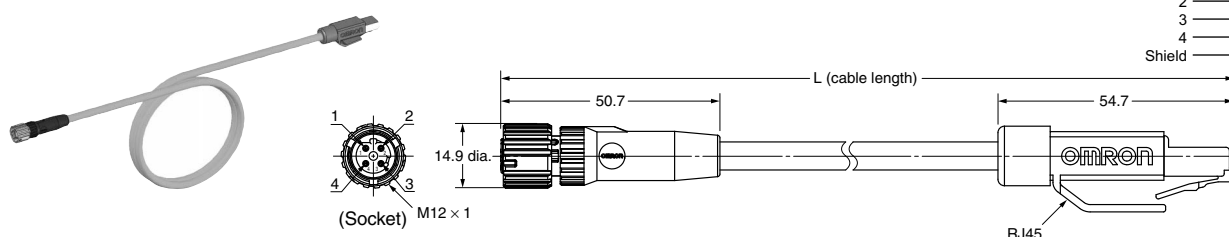

● Cable with Plug One End (M12 Right-angle)  
XS5H-T422-□M0-K

Wiring

Terminal No.	Color
1	Yellow
2	White
3	Orange
4	Blue

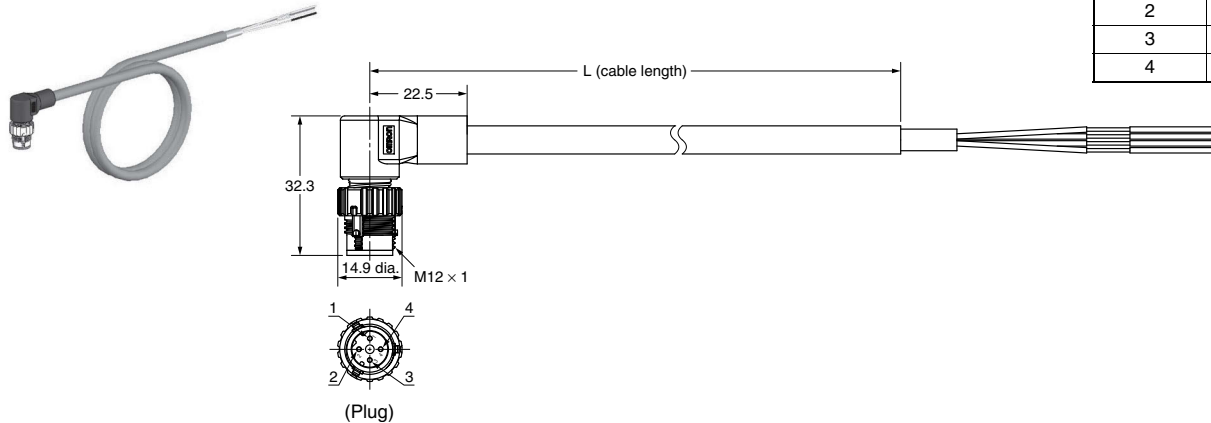

● Cable with Plugs on Both Ends (M12 Right-angle/M12 Right-angle)  
XS5W-T422-□M2-K

Wiring

M12 right angle	M12 right angle
1	1
2	2
3	3
4	4
Shield	Shield

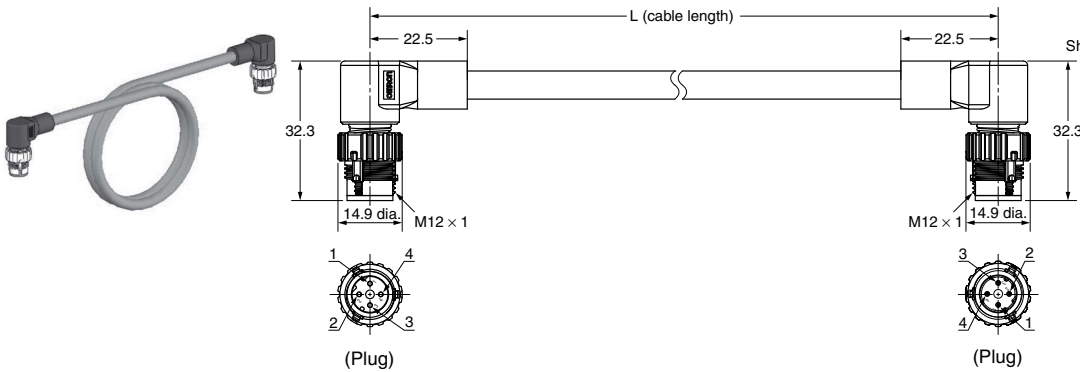

● Cable with Plugs on Both Ends (M12 Right-angle/RJ45)  
XS5W-T422-□MC-K

Wiring

M12 right angle	RJ45
1	1
2	3
3	2
4	6
Shield	Shield

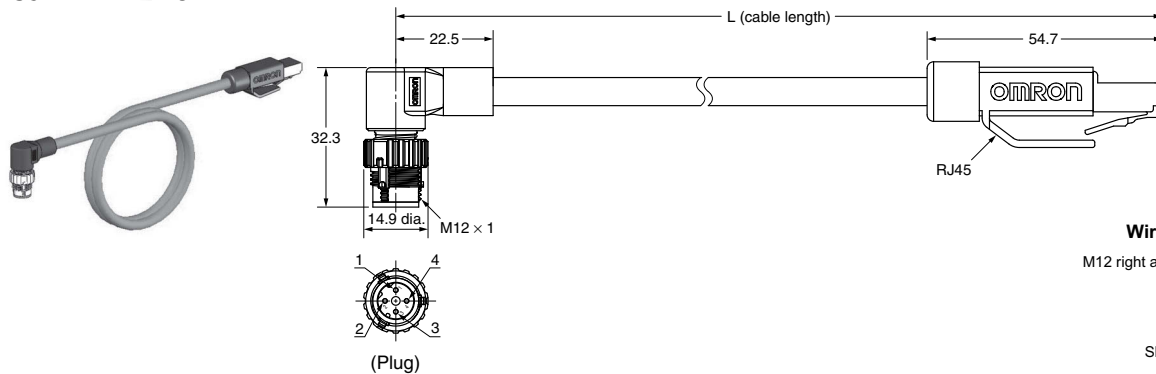

● Cable with Plugs on Both Ends (RJ45/RJ45)  
XS5W-T421-□MD-K  
XS5W-T421-□MD-KR

Wiring

RJ45	RJ45
1	1
2	2
3	3
6	6
Shield	Shield

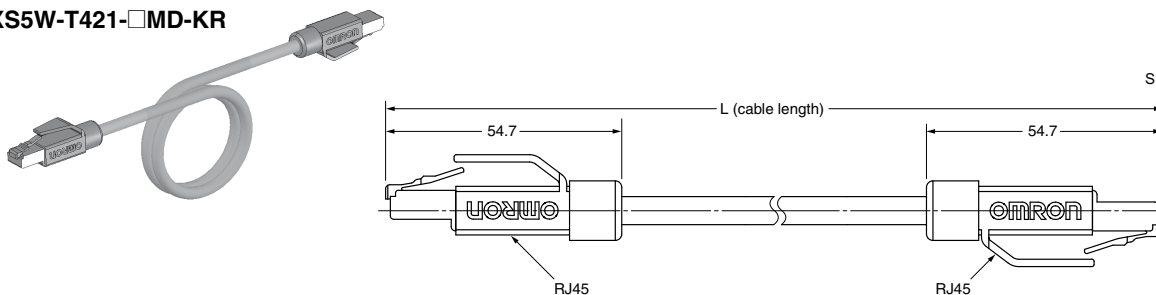

## ● RJ45 Assembly Connector XS6G-T421-1

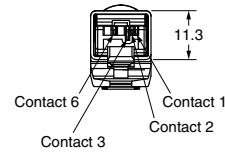
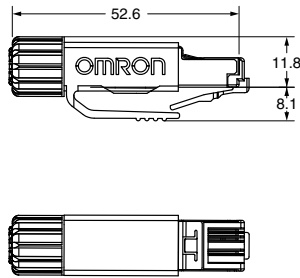

### Applicable wires

Sheath outer diameter: 6.1 to 6.9 mm  
Core size: AWG22 to AWG24 (stranded wires)  
AWG22 to AWG23 (solid wires)  
Insulation outer diameter: 1.6 mm max.

## ● M12 Connector for Panel Mounting XS5P-T42□-5



### XS5P-T426-5 (Rear Locking)

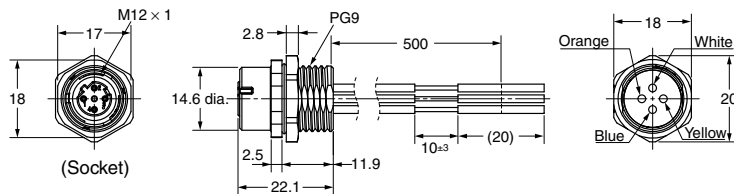

### XS5P-T427-5 (Front Locking)

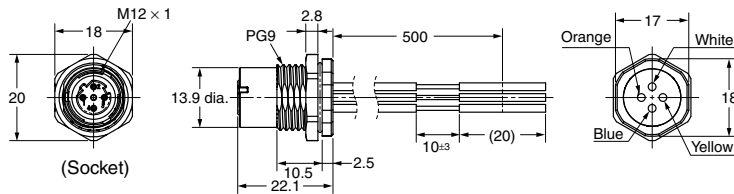

### Wiring

Terminal No.	Color
1	Yellow
2	White
3	Orange
4	Blue

### Panel Cutout Dimension

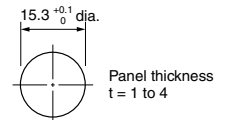

Note 1: The panel cutout dimension is the same for Front-locking and Rear-locking Connectors.

Note 2: Rotational positioning is not possible for connector rotation.

## ● M12 Panel-mounting PCB Straight Terminals XS5P-T426-1

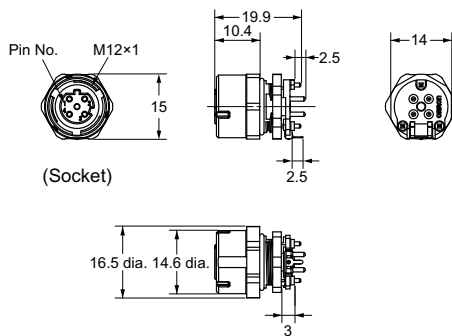

### Mounting Hole Dimensions (D Cut Structure)

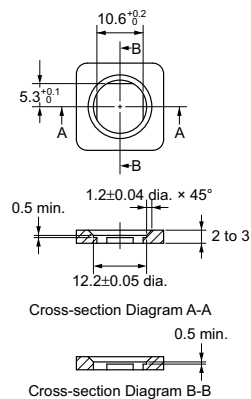

### Mounting Hole Dimensions (D Cut Structure)

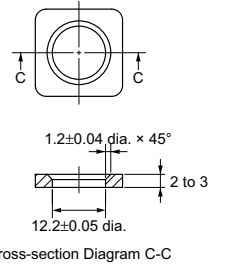

### Panel Processing Dimensions

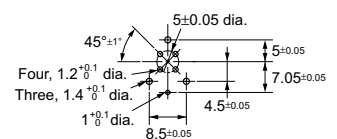

## Assembly Procedure

### ● RJ45 Assembly Connectors

#### XS6G-T421-1

1. Pass the cable through the cable clamp and the connector housing
2. Strip the cable sheath and ground braiding to the correct lengths.
3. Follow the color codes and prepare to insert the wires into the splice piece.
4. Insert the wires into the splice piece for the length of the splice piece.
5. Place the splice piece into the RJ45 data module and engage it.
6. Place the data module and the splice piece on the IDC assembly housing.
7. Press the data module and the IDC assembly housing together and use pliers or a similar device to make the insulation displacement contact.
8. Remove the data module from the IDC assembly housing.
9. Place the upper screen plate on the data module and press it over the ground braiding of the cable.
10. Place the lower screen plate on the bottom of the data module, align it with the upper screen plate, and latch it until you hear it click into place.
11. Slide the housing that you placed around the cable in step 1 up to the data module and latch it until you hear it click into place.
12. Tighten the cable clamp.

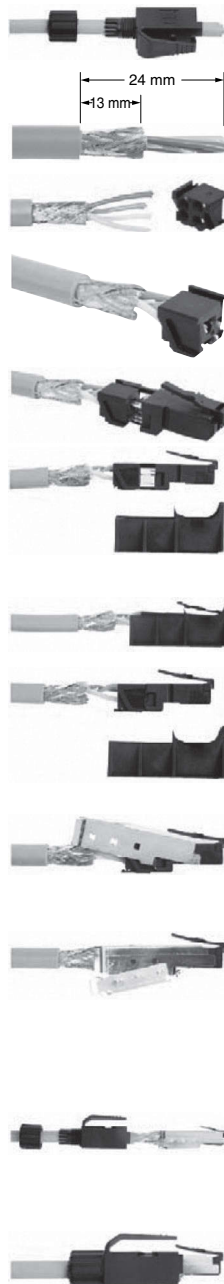

### Pin Assignments

Pin Assignments for Fast Ethernet 10/100 Mbps

Function/Signal	Wire color			Pin No.
	Industrial Ethernet	EIA/TIA 568A	EIA/TIA 568B	
Transmission Data+/TD+	YE	WH/GN	WH/OG	1
Transmission Data-/TD-	OG	GN	OG	2
Receiver Data/RD+	WH	WH/OG	WH	3
Receiver Data/RD-	BU	OG	GN	6

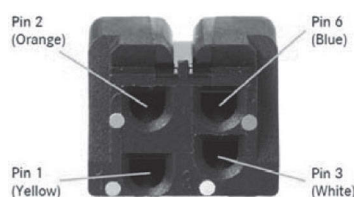

### ● M12 Panel-mounting PCB Straight Terminals

#### XS5P-T426-1

#### Confirming the Number of Parts

The following four parts are included in the package when it is delivered.

#### Panel-mounting Parts

1. Anchor

2. O-Ring

3. Nut

#### PCB-mounting Part

4. Connector



#### Assembly Procedure

1. Mount the connector to the PCB.
2. Attach the anchor to the panel with the nut.

Mounting the Connector to the PCB

Mounting the Anchor to the Panel

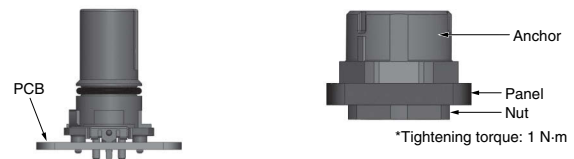

3. Attach the connector that you mounted to the PCB to the panel.

\* Make sure that the connector and anchor are oriented correctly.

Attachment

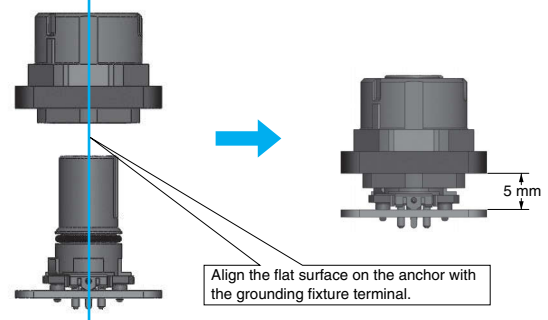

4. Temporarily mount the O-ring to the top of the connector at the mating surface.

Temporary Mounting of the O-Ring

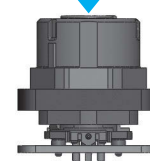

5. Mate the Connector Waterproof Cover (XS2Z-22, sold separately) or the Partner Connector Plug (XS5H-T42□-□M0-K, sold separately) and press the O-ring to the O-ring position after mounting.

Mounting the O-Ring

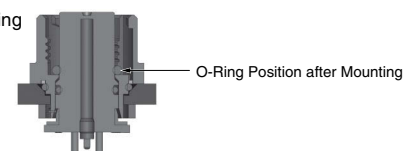

### ● Connector Waterproof Cover (Sold Separately)

#### XS2Z-22

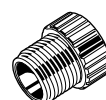

\* Tightening torque: 0.39 to 0.49 N·m

## ■ Safety Precautions

### Precautions for Correct Use

Do not use the Connectors in an atmosphere or environment that exceeds the specifications.

#### ● Connector Connection and Disconnection

- When connecting or disconnecting Connectors, be sure to hold the Connectors.
- Do not hold the cable when disconnecting Connectors.
- When joining Connectors, be sure to insert the plug all the way to the back of the socket before attempting to lock the Connectors.
- Do not use tools of any sort to join the Connectors. Always use your hands. Pliers or other tools may damage the Connectors.

#### ● Wiring

Lay the cables so that external force is not applied to the Connectors. Otherwise, the degree of protection (IP67) may not be achieved.

#### ● Degree of Protection for M12/Smartclick Connectors

- The degree of protection of Connectors (IP67) is not for a fully watertight structure. Do not use the Connectors underwater.
- Do not step on or place any objects on the Connectors. Doing so may damage the Connectors.

#### ● Handling Precautions

- Do not pull on the Connectors or cables with excessive force. Do not install the Connectors with a load placed directly on the joint or at the point where the wires connect to the Connector. The Connector may be damaged or the wires in the cable may be disconnected.
- Lay the cable where it will not be stepped on to prevent the wires in the cable from being disconnected and to protect the Connectors from being damaged. If the cable must be placed where it will be stepped on, install a protective cover.
- When bending cables, do not exceed the cable specifications.

# Terms and Conditions of Sale

1. **Offer; Acceptance.** These terms and conditions (these "**Terms**") are deemed part of all quotes, agreements, purchase orders, acknowledgments, price lists, catalogs, manuals, brochures and other documents, whether electronic or in writing, relating to the sale of products or services (collectively, the "**Products**") by Omron Electronics LLC and its subsidiary companies ("**Omron**"). Omron objects to any terms or conditions proposed in Buyer's purchase order or other documents which are inconsistent with, or in addition to, these Terms.
2. **Prices; Payment Terms.** All prices stated are current, subject to change without notice by Omron. Omron reserves the right to increase or decrease prices on any unshipped portions of outstanding orders. Payments for Products are due net 30 days unless otherwise stated in the invoice.
3. **Discounts.** Cash discounts, if any, will apply only on the net amount of invoices sent to Buyer after deducting transportation charges, taxes and duties, and will be allowed only if (i) the invoice is paid according to Omron's payment terms and (ii) Buyer has no past due amounts.
4. **Interest.** Omron, at its option, may charge Buyer 1-1/2% interest per month or the maximum legal rate, whichever is less, on any balance not paid within the stated terms.
5. **Orders.** Omron will accept no order less than \$200 net billing.
6. **Governmental Approvals.** Buyer shall be responsible for, and shall bear all costs involved in, obtaining any government approvals required for the importation or sale of the Products.
7. **Taxes.** All taxes, duties and other governmental charges (other than general real property and income taxes), including any interest or penalties thereon, imposed directly or indirectly on Omron or required to be collected directly or indirectly by Omron for the manufacture, production, sale, delivery, importation, consumption or use of the Products sold hereunder (including customs duties and sales, excise, use, turnover and license taxes) shall be charged to and remitted by Buyer to Omron.
8. **Financial.** If the financial position of Buyer at any time becomes unsatisfactory to Omron, Omron reserves the right to stop shipments or require satisfactory security or payment in advance. If Buyer fails to make payment or otherwise comply with these Terms or any related agreement, Omron may (without liability and in addition to other remedies) cancel any unshipped portion of Products sold hereunder and stop any Products in transit until Buyer pays all amounts, including amounts payable hereunder, whether or not then due, which are owing to it by Buyer. Buyer shall in any event remain liable for all unpaid accounts.
9. **Cancellation; Etc.** Orders are not subject to rescheduling or cancellation unless Buyer indemnifies Omron against all related costs or expenses.
10. **Force Majeure.** Omron shall not be liable for any delay or failure in delivery resulting from causes beyond its control, including earthquakes, fires, floods, strikes or other labor disputes, shortage of labor or materials, accidents to machinery, acts of sabotage, riots, delay in or lack of transportation or the requirements of any government authority.
11. **Shipping; Delivery.** Unless otherwise expressly agreed in writing by Omron:
  - a. Shipments shall be by a carrier selected by Omron; Omron will not drop ship except in "break down" situations.
  - b. Such carrier shall act as the agent of Buyer and delivery to such carrier shall constitute delivery to Buyer;
  - c. All sales and shipments of Products shall be FOB shipping point (unless otherwise stated in writing by Omron), at which point title and risk of loss shall pass from Omron to Buyer; provided that Omron shall retain a security interest in the Products until the full purchase price is paid;
  - d. Delivery and shipping dates are estimates only; and
  - e. Omron will package Products as it deems proper for protection against normal handling and extra charges apply to special conditions.
12. **Claims.** Any claim by Buyer against Omron for shortage or damage to the Products occurring before delivery to the carrier must be presented in writing to Omron within 30 days of receipt of shipment and include the original transportation bill signed by the carrier noting that the carrier received the Products from Omron in the condition claimed.
13. **Warranties.** (a) **Exclusive Warranty.** Omron's exclusive warranty is that the Products will be free from defects in materials and workmanship for a period of twelve months from the date of sale by Omron (or such other period expressed in writing by Omron). Omron disclaims all other warranties, express or implied. (b) **Limitations.** OMRON MAKES NO WARRANTY OR REPRESENTATION, EXPRESS OR IMPLIED, ABOUT NON-INFRINGEMENT, MERCHANTABILITY OR FITNESS FOR A PARTICULAR PURPOSE OF THE PRODUCTS. BUYER ACKNOWLEDGES THAT IT ALONE HAS DETERMINED THAT THE PRODUCTS WILL SUITABLY MEET THE REQUIREMENTS OF THEIR INTENDED USE. Omron further disclaims all warranties and responsibility of any type for claims or expenses based on infringement by the Products or otherwise of any intellectual property right. (c) **Buyer Remedy.** Omron's sole obligation hereunder shall be, at Omron's election, to (i) replace (in the form originally shipped with Buyer responsible for labor charges for removal or replacement thereof) the non-complying Product, (ii) repair the non-complying Product, or (iii) repay or credit Buyer an amount equal to the purchase price of the non-complying Product; provided that in no event shall Omron be responsible for warranty, repair, indemnity or any other claims or expenses regarding the Products unless Omron's analysis confirms that the Products were properly handled, stored, installed and maintained and not subject to contamination, abuse, misuse or inappropriate modification. Return of any Products by Buyer must be approved in writing by Omron before shipment. Omron Companies shall not be liable for the suitability or unsuitability or the results from the use of Products in combination with any electrical or electronic components, circuits, system assemblies or any other materials or substances or environments. Any advice, recommendations or information given orally or in writing, are not to be construed as an amendment or addition to the above warranty. See [http://](#) or contact your Omron representative for published information.
14. **Limitation on Liability; Etc.** OMRON COMPANIES SHALL NOT BE LIABLE FOR SPECIAL, INDIRECT, INCIDENTAL, OR CONSEQUENTIAL DAMAGES, LOSS OF PROFITS OR PRODUCTION OR COMMERCIAL LOSS IN ANY WAY CONNECTED WITH THE PRODUCTS, WHETHER SUCH CLAIM IS BASED IN CONTRACT, WARRANTY, NEGLIGENCE OR STRICT LIABILITY. Further, in no event shall liability of Omron Companies exceed the individual price of the Product on which liability is asserted.
15. **Indemnities.** Buyer shall indemnify and hold harmless Omron Companies and their employees from and against all liabilities, losses, claims, costs and expenses (including attorney's fees and expenses) related to any claim, investigation, litigation or proceeding (whether or not Omron is a party) which arises or is alleged to arise from Buyer's acts or omissions under these Terms or in any way with respect to the Products. Without limiting the foregoing, Buyer (at its own expense) shall indemnify and hold harmless Omron and defend or settle any action brought against such Companies to the extent based on a claim that any Product made to Buyer specifications infringed intellectual property rights of another party.
16. **Property; Confidentiality.** Any intellectual property in the Products is the exclusive property of Omron Companies and Buyer shall not attempt to duplicate it in any way without the written permission of Omron. Notwithstanding any charges to Buyer for engineering or tooling, all engineering and tooling shall remain the exclusive property of Omron. All information and materials supplied by Omron to Buyer relating to the Products are confidential and proprietary, and Buyer shall limit distribution thereof to its trusted employees and strictly prevent disclosure to any third party.
17. **Export Controls.** Buyer shall comply with all applicable laws, regulations and licenses regarding (i) export of products or information; (ii) sale of products to "forbidden" or other proscribed persons; and (iii) disclosure to non-citizens of regulated technology or information.
18. **Miscellaneous.** (a) **Waiver.** No failure or delay by Omron in exercising any right and no course of dealing between Buyer and Omron shall operate as a waiver of rights by Omron. (b) **Assignment.** Buyer may not assign its rights hereunder without Omron's written consent. (c) **Law.** These Terms are governed by the law of the jurisdiction of the home office of the Omron company from which Buyer is purchasing the Products (without regard to conflict of law principles). (d) **Amendment.** These Terms constitute the entire agreement between Buyer and Omron relating to the Products, and no provision may be changed or waived unless in writing signed by the parties. (e) **Severability.** If any provision hereof is rendered ineffective or invalid, such provision shall not invalidate any other provision. (f) **Setoff.** Buyer shall have no right to set off any amounts against the amount owing in respect of this invoice. (g) **Definitions.** As used herein, "including" means "including without limitation"; and "Omron Companies" (or similar words) mean Omron Corporation and any direct or indirect subsidiary or affiliate thereof.

## Certain Precautions on Specifications and Use

1. **Suitability of Use.** Omron Companies shall not be responsible for conformity with any standards, codes or regulations which apply to the combination of the Product in the Buyer's application or use of the Product. At Buyer's request, Omron will provide applicable third party certification documents identifying ratings and limitations of use which apply to the Product. This information by itself is not sufficient for a complete determination of the suitability of the Product in combination with the end product, machine, system, or other application or use. Buyer shall be solely responsible for determining appropriateness of the particular Product with respect to Buyer's application, product or system. Buyer shall take application responsibility in all cases but the following is a non-exhaustive list of applications for which particular attention must be given: (i) Outdoor use, uses involving potential chemical contamination or electrical interference, or conditions or uses not described in this document. (ii) Use in consumer products or any use in significant quantities. (iii) Energy control systems, combustion systems, railroad systems, aviation systems, medical equipment, amusement machines, vehicles, safety equipment, and installations subject to separate industry or government regulations. (iv) Systems, machines and equipment that could present a risk to life or property. Please know and observe all prohibitions of use applicable to this Product. NEVER USE THE PRODUCT FOR AN APPLICATION INVOLVING SERIOUS RISK TO LIFE OR PROPERTY OR IN LARGE QUANTITIES WITHOUT ENSURING THAT THE SYSTEM AS A WHOLE HAS BEEN DESIGNED TO ADDRESS THE RISKS, AND THAT THE OMRON'S PRODUCT IS PROPERLY RATED AND INSTALLED FOR THE INTENDED USE WITHIN THE OVERALL EQUIPMENT OR SYSTEM.
2. **Programmable Products.** Omron Companies shall not be responsible for the user's programming of a programmable Product, or any consequence thereof.
3. **Performance Data.** Data presented in Omron Company websites, catalogs and other materials is provided as a guide for the user in determining suitability and does not constitute a warranty. It may represent the result of Omron's test conditions, and the user must correlate it to actual application requirements. Actual performance is subject to the Omron's Warranty and Limitations of Liability.
4. **Change in Specifications.** Product specifications and accessories may be changed at any time based on improvements and other reasons. It is our practice to change part numbers when published ratings or features are changed, or when significant construction changes are made. However, some specifications of the Product may be changed without any notice. When in doubt, special part numbers may be assigned to fix or establish key specifications for your application. Please consult with your Omron's representative at any time to confirm actual specifications of purchased Product.
5. **Errors and Omissions.** Information presented by Omron Companies has been checked and is believed to be accurate; however, no responsibility is assumed for clerical, typographical or proofreading errors or omissions.



**OMRON AUTOMATION AND SAFETY • THE AMERICAS HEADQUARTERS** • Chicago, IL USA • 847.843.7900 • 800.556.6766 •

**OMRON CANADA, INC. • HEAD OFFICE**

Toronto, ON, Canada • 416.286.6465 • 866.986.6766 •

**OMRON ELECTRONICS DE MEXICO • HEAD OFFICE**

México DF • 52.55.59.01.43.00 • 01-800-226-6766 • mela@omron.com

**OMRON ELECTRONICS DE MEXICO • SALES OFFICE**

Apodaca, N.L. • 52.81.11.56.99.20 • 01-800-226-6766 • mela@omron.com

**OMRON ELETRÔNICA DO BRASIL LTDA • HEAD OFFICE**

São Paulo, SP, Brasil • 55.11.2101.6300 • www.omron.com.br

**OMRON ARGENTINA • SALES OFFICE**

Cono Sur • 54.11.4783.5300

**OMRON CHILE • SALES OFFICE**

Santiago • 56.9.9917.3920

**OTHER OMRON LATIN AMERICA SALES**

54.11.4783.5300

**OMRON EUROPE B.V.** • Wegalaan 67-69, NL-2132 JD, Hoofddorp, The Netherlands. • +31 (0) 23 568 13 00 • www.industrial.omron.eu

*Authorized Distributor:*

**Automation Control Systems**

- Machine Automation Controllers (MAC) • Programmable Controllers (PLC)
- Operator interfaces (HMI) • Distributed I/O • Software

**Drives & Motion Controls**

- Servo & AC Drives • Motion Controllers & Encoders

**Temperature & Process Controllers**

- Single and Multi-loop Controllers

**Sensors & Vision**

- Proximity Sensors • Photoelectric Sensors • Fiber-Optic Sensors
- Amplified Photomicrosensors • Measurement Sensors
- Ultrasonic Sensors • Vision Sensors

**Industrial Components**

- RFID/Code Readers • Relays • Pushbuttons & Indicators
- Limit and Basic Switches • Timers • Counters • Metering Devices
- Power Supplies

**Safety**

- Laser Scanners • Safety Mats • Edges and Bumpers • Programmable Safety Controllers • Light Curtains • Safety Relays • Safety Interlock Switches