

102A SERIES

3-Phase Voltage/Phase Monitor



Description

The 102A is a 3-phase, auto-ranging, dual-range voltage monitor that protects 190-400VAC, 50/60Hz motors regardless of size. The product provides a user selectable nominal voltage setpoint and the voltage monitor automatically selects between the 200V and 400V range.

A unique microcontroller-based voltage and phase-sensing circuit constantly monitors the 3-phase voltages to detect harmful power line conditions. When a harmful condition is detected, the output relay is deactivated after a specified trip delay. The output relay reactivates after power line conditions return to acceptable levels. The Model 102A includes advanced single LED diagnostics. Five different light patterns distinguish between faults and normal conditions.

Features & Benefits

FEATURES	BENEFITS
Proprietary microcontroller based circuitry	Constant monitoring of single-phase, low voltage, high voltage (102A-9), voltage unbalance, phase reversal, harmful power line conditions.
Auto-sensing wide voltage range	Automatically senses system voltage between 190 - 480VAC. Saves setup time.
Advanced LED diagnostics	Quick visual indicator for cause of trip. LED indications include: normal operation, power-up restart delay, reverse-phase trip, unbalance/single-phase trip, high or low voltage trip
Adjustable trip delay (102A2)	Prevent nuisance tripping due to rapidly fluctuating power line conditions.

Wiring Diagram

102 WITH MOTOR CONTROL

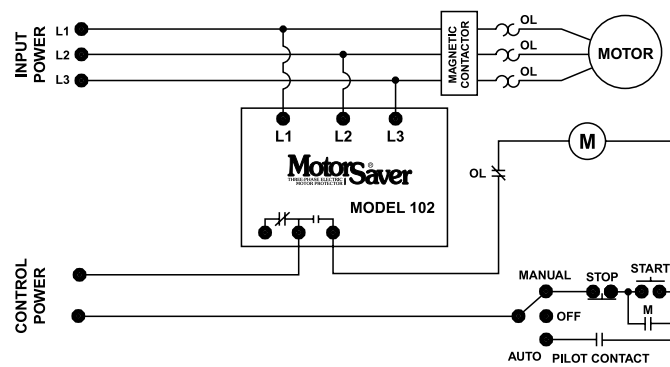

102 WITH ALARM CONTROL

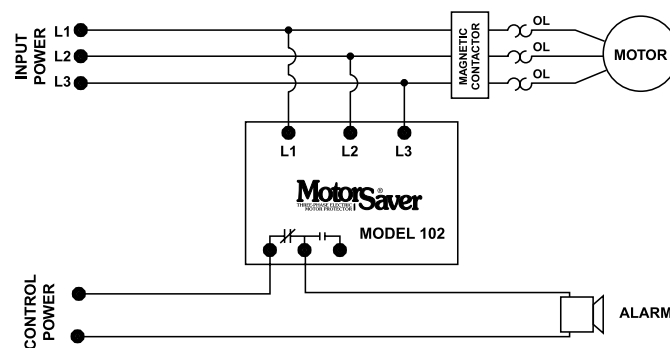

Ordering Information

MODEL	LINE VOLTAGE	DESCRIPTION
102A	190-480VAC	Fixed low voltage trip delay (4 sec), fixed restart delay (2 sec)
102A2	190-480VAC	Has variable restart delay (manual or adjustable 2-300 seconds)
102A3	190-480VAC	Has adjustable trip delay at 2-30 seconds (unbalance and phasing trip delays remain at 2 seconds).
102A-9	190-480VAC	Has high voltage protection. High Voltage Trip is 110% of setpoint, Reset is 107% of setpoint.
102600	475-600VAC	Fixed low voltage trip delay (4 sec), fixed restart delay (2 sec)

102A SERIES

Specifications

Frequency	50*/60Hz
Functional Characteristics	
Low Voltage (% of setpoint)	
Trip	90%
Reset	93%
Voltage Unbalance (NEMA)	
Trip	6%
Reset	4.5%
Trip Delay Time	
Low/High Voltage	4 seconds (standard)
Unbalance & Phasing Faults	2 seconds
Restart Delay Time	
After a Fault	2 seconds (standard)
After a Complete Power Loss	2 seconds (standard)
Output Characteristics	
Output Contact Rating (SPDT - 1 Form C)	
Pilot Duty	480VA @ 240VAC
General Purpose	10A @ 240VAC

General Characteristics

Ambient Temperature Range	
Operating	-40° to 70°C (-40° to 158°F)
Storage	-40° to 80°C (-40° to 176°F)
Trip & Reset Accuracy	±1%
Maximum Input Power	5 W
Terminal	
Torque	7 in.-lbs.
Wire Size	12-18AWG
Standards Passed	
Electrostatic Discharge (ESD)	IEC 61000-4-2, Level 3, 6kV contact, 8kV air
Fast Transient Burst	IEC 61000-4-4, Level 3, 4kV input, 2kV input/output
Transient Protection (Internal)	IEC 61000-4-5; 1995 ±6kV
Safety Marks	
UL	UL508 (File #E68520)
CSA	22.2 No. 14 (File #46510)
CE	IEC 60947-6-2
Dimensions	
	H 74.4 mm (2.93"); W 133.9 mm (5.27");
	D 74.9 mm (2.95")
Weight	1.05 lbs. (16.8 oz., 476.27 g)
Mounting Method	#8 screws

*Note: 50Hz will increase all delay timers by 20%.