

EDS94AYAE
13380800

L-force *Drives*

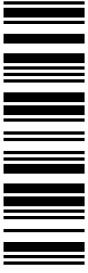

Translation **Manual**

9400

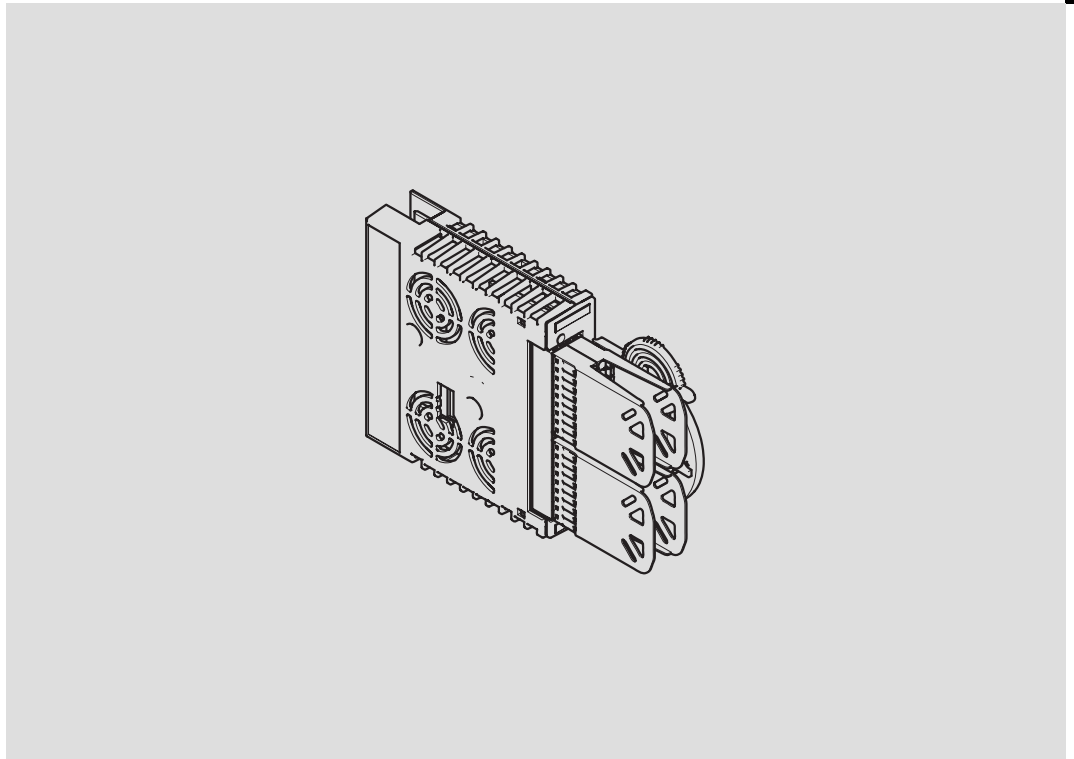

E94AYAE - SM301

Safety module

Lenze



Please read these instructions and the documentation of the standard device before you start working!
Observe the safety instructions given therein!

© 2011 Lenze Automation GmbH, Hans-Lenze-Str. 1, D-31855 Aerzen

No part of this documentation may be reproduced or made accessible to third parties without written consent by Lenze Automation GmbH.

All information given in this documentation has been selected carefully and complies with the hardware and software described. Nevertheless, discrepancies cannot be ruled out. We do not take any responsibility or liability for any damage that may occur. Necessary corrections will be included in subsequent editions.

1 Safety engineering

Contents

1	Safety engineering	3
1.1	Basics	5
1.1.1	Introduction	5
1.1.2	Drive-based safety with L-force 9400	5
1.1.3	Terms and abbreviations of the safety engineering	6
1.1.4	Important notes	7
1.1.5	Safety instructions	8
1.1.6	Hazard and risk analysis	10
1.1.7	Standards	10
1.1.8	Safety instructions for the installation according to UL or UR	10
1.1.9	Overview of sensors	11
1.2	Device modules	12
1.2.1	Slot	12
1.2.2	Function mode of the safety modules	14
1.2.3	SM301 safety module	15
1.2.4	Safe inputs	30
1.2.5	Safe output	37
1.2.6	Further inputs	41
1.2.7	Safe speed measurement and position detection	42
1.3	Safety functions	48
1.3.1	General information	48
1.3.2	Integration into the application of the controller	51
1.3.3	Safe torque off	54
1.3.4	Safe stop 1	56
1.3.5	Safe stop 2	60
1.3.6	Ramp monitoring SS1/SS2	64
1.3.7	Emergency stop	67
1.3.8	Safe maximum speed	68
1.3.9	Safely limited speed	71
1.3.10	Safe direction	74
1.3.11	Safe operation mode selector	78
1.3.12	Safe enable switch	84
1.3.13	Cascading	85
1.4	Safety address	88
1.5	Safe bus interfaces	90
1.5.1	PROFIsafe connection	90

1.6	Safe parameter setting	100
1.6.1	Parameter setting	100
1.6.2	Parameter sets and axes	102
1.7	Error management	103
1.7.1	Error states	103
1.7.2	Logbook function in the controller	104
1.7.3	Logbook function in the SM301	104
1.8	Response times	106
1.8.1	Response times of the inputs	107
1.8.2	Response time of the safe output	107
1.8.3	Response times of the safety bus	107
1.8.4	Response time of encoder monitoring	108
1.9	Acceptance	109
1.9.1	Description	109
1.9.2	Periodic inspections	110
1.10	Appendix	111
1.10.1	Module internal codes	111
1.10.2	Module error messages	132
1.11	Total index	136

1.1 Basics

1.1.1 Introduction

With increasing automation, protection of persons against hazardous movements is becoming more important. Functional safety describes the measures needed by means of electrical or electronic equipment to reduce or remove danger caused by failures.

During normal operation, safety equipment prevents people accessing hazardous areas. In certain operating modes, e.g. set-up mode, work needs to be carried out in hazardous areas. In these situations the machine operator must be protected by integrated drive and control measures.

Drive-based safety provides the conditions in the controls and drives to optimise the safety functions. Planning and installation expenditure is reduced. In comparison to the use of standard safety engineering, drive-based safety increases machine functionality and availability.

1.1.2 Drive-based safety with L-force | 9400

The controllers of the L-force|9400 range can be equipped with a safety module. The functional range of the safety module types varies in order to optimally implement different applications.

”Drive-based safety” stands for applied safety functions, which can be used for the protection of persons working on machines.

The motion functions are continued to be executed by the controller. The safety modules monitor the safe compliance with the limit values and provide the safe inputs and outputs. When the limit values are exceeded the safety modules start the control functions according to EN 60204-1 directly in the controller.

The safety functions are suitable for applications according to IEC 61508 to SIL 3 and meet, depending on the module, the requirements of Performance Level e (PL e) and control category 4 according to EN ISO 13849-1.

1 Safety engineering

Basics

Terms and abbreviations of the safety engineering

1.1.3 Terms and abbreviations of the safety engineering

Abbreviation	Meaning
9400	Lenze servo controller
Cat.	Category according to EN ISO 13849-1 (formerly EN 954-1)
OSSD	Output Signal Switching Device, tested signal output
PS	PROFIsafe
PWM	Pulse width modulation
SD-In	Safe input (Safe Digital Input)
SD-Out	Safe output (Safe Digital Output)
SIL	Safety Integrity Level according to IEC 61508
SM	Safety module
Optocoupler supply	Optocoupler supply for the driver control
PELV	Protective extra low voltage
SELV	Safety extra low voltage
OFF state	Signal status of the safety sensor technology when it is released or responding
ON state	Signal status of the safety sensor technology in normal operation
PM	PN-switched signal paths
PP	PP-switched signal paths
GSE	File containing device-specific data to establish PROFIBUS communication
GSDML	File containing device-specific data to establish PROFINET communication
S-Bus	Safety bus
Abbreviation	Safety function
SLS	Safely limited speed
SLI	Safely limited increment
SOS	Safe operating stop
SS1	Safe stop 1
SS2	Safe stop 2
SSM	Safe speed monitor
STO	Safe torque off Formerly: safe standstill
SMS	Safe maximum speed
SDI	Safe direction
SSE	Safe stop emergency
ES	Safe enable switch
OMS	Operation mode selector
AIE	Error acknowledgement (Acknowledge In Error)
AIS	Restart acknowledgement (Acknowledge In Stop)



1.1.4 Important notes

The following pictographs and signal words are used in this documentation to indicate dangers and important information:



Safety instructions

Structure of safety instructions:



	Danger! (characterises the type and severity of danger)
	Note (describes the danger and gives information about how to prevent dangerous situations)

Pictograph and signal word	Meaning
 Danger!	Danger of personal injury through dangerous electrical voltage. Reference to an imminent danger that may result in death or serious personal injury if the corresponding measures are not taken.
 Danger!	Danger of personal injury through a general source of danger. Reference to an imminent danger that may result in death or serious personal injury if the corresponding measures are not taken.
 Stop!	Danger of property damage. Reference to a possible danger that may result in property damage if the corresponding measures are not taken.

Application notes

Pictograph and signal word	Meaning
 Note!	Important note to ensure troublefree operation
 Tip!	Useful tip for simple handling
	Reference to another documentation

Special safety instructions and application notes for UL and UR

Pictograph and signal word	Meaning
 Warnings!	Safety or application note for the operation of a UL-approved device in UL-approved systems. Possibly the drive system is not operated in compliance with UL if the corresponding measures are not taken.
 Warnings!	Safety or application note for the operation of a UR-approved device in UL-approved systems. Possibly the drive system is not operated in compliance with UL if the corresponding measures are not taken.

1 Safety engineering

Basics

Safety instructions

1.1.5 Safety instructions

Application as directed

The safety modules SMx (E94AYAx) may only be used together with Lenze drive controllers of the L-force | 9400 (E94A...) series.

Any other use shall be deemed inappropriate!

Installation/commissioning



Danger!

Danger to life through improper installation

Improper installation of the safety engineering systems can cause an uncontrolled starting action of the drives.

Possible consequences:

- ▶ Death or severe injuries

Protective measures:

- ▶ Safety engineering systems may only be installed and commissioned by qualified and skilled personnel.
- ▶ All control components (switches, relays, PLC, ...) and the control Cabinet must comply with the requirements of EN ISO 13849-1 and EN ISO 138492. This includes:
 - Switches, relays in IP54 enclosure.
 - Control cabinet in IP54 enclosure.
 - Please refer to EN ISO 13849-1 and EN ISO 138492 for all further requirements.
- ▶ It is essential to use insulated wire end ferrules for wiring.
- ▶ All safety relevant cables outside the control cabinet must be protected, e.g. by means of a cable duct:
 - Ensure that there are no short circuits.
 - For further measures see EN ISO 138492.
- ▶ If an external force acts upon the drive axes, additional brakes are required. Please observe that hanging loads are subject to the force of gravity!

**Danger!**

When the request for the safety function is deactivated, the drive can restart automatically. The behaviour can be set via the parameter "Restart behaviour" (C15300/1/2).

In the case of an automatic restart, you must provide external measures which ensure that the drive only restarts after an acknowledgement (EN 60204).

**Danger!**

When the "safe torque off" (STO) function is used, an "emergency switching-off" according to EN 60204 is not possible without additional measures. There is no electrical isolation, no service switch or repair switch between motor and controller!

"Emergency switching-off" requires an electrical isolation, e.g. by a central mains contactor!

During operation

After the installation is completed, the operator must check the wiring of the safety function.

The functional test must be repeated at regular intervals. The time intervals to be selected depend on the application, the entire system and the corresponding risk analysis. The inspection interval should not exceed one year.

Residual hazards

In case of a short-circuit of two power transistors a residual movement of the motor of up to 180° /number of pole pairs may occur! (Example: 4-pole motor \Rightarrow residual movement max. $180^\circ/2 = 90^\circ$)

This residual movement must be considered in the risk analysis, e.g. safe torque off for main spindle drives.

1 Safety engineering

Basics

Hazard and risk analysis

1.1.6 Hazard and risk analysis

This documentation can only accentuate the need for hazard analysis. The user of the integrated safety system must read up on standards and the legal situation:

Before the launch of a machine, the manufacturer of the machine must conduct a hazard analysis according to Machinery Directive 2006/42/EC to determine the hazards associated with the application of the machine. The Machinery Directive refers to three basic principles for the highest possible level of safety:

- ▶ Hazard elimination / minimisation by the construction itself.
- ▶ Required protective measures must be taken against hazards which cannot be eliminated.
- ▶ Existing residual hazards must be documented and the user must be informed of them.

Detailed information on the hazard analysis procedure is provided in the EN 1050, risk assessment principles. The results of the hazard analysis determine the category for safety-related control systems according to EN ISO 13849-1. Safety-oriented parts of the machine control must be compliant.

1.1.7 Standards

Safety regulations are confirmed by laws and other governmental guidelines and measures and the prevailing opinion among experts, e.g. by technical regulations.

The regulations and rules to be applied must be observed in accordance with the application.

1.1.8 Safety instructions for the installation according to U_L or U_R



Warnings!

- ▶ Maximum surrounding air temperature: 55 °C.
- ▶ External fuse for 24 Vdc supply voltage. Rated 4 A DC fuse UL248-14.

1.1.9 Overview of sensors

Passive sensors

Passive sensors are two-channel switching elements with contacts. The connecting cables and the sensor function must be monitored.

The contacts must switch simultaneously (equivalently). Nevertheless, safety functions will be activated as soon as at least one channel is switched.

The switches must be wired according to the closed-circuit principle.

Examples of passive sensors:

- ▶ Door contact switch
- ▶ Emergency-off control units

Active sensors

Active sensors are units with 2-channel semiconductor outputs (OSSD outputs). With the integrated safety system of this device series, test pulses < 1 ms for monitoring the outputs and cables are permissible. The maximally permissible connection capacity of the outputs is to be observed.

P/M-switching sensors switch the positive and negative cable or the signal and ground wire of a sensor signal.

The outputs have to switch simultaneously. Nevertheless, safety functions are triggered as soon as at least one channel is switched.

Examples of active sensors:

- ▶ Lightgrid
- ▶ Laser scanner
- ▶ Control systems

Sensor inputs

For unused sensor inputs, "Input deactivated" must be parameterised.

Connected deactivated sensors can create the false impression of safety technology being provided. For this reason, a deactivation of sensors by parameter setting only is not permissible and not possible. It is monitored that no sensor signal is pending.

1 Safety engineering

Device modules
Slot

1.2 Device modules

1.2.1 Slot

The slot for the safety modules is marked in the documentation with M4. It is the lowest slot in the controller (see overview in the documentation of the controller).

1.2.1.1 Mounting

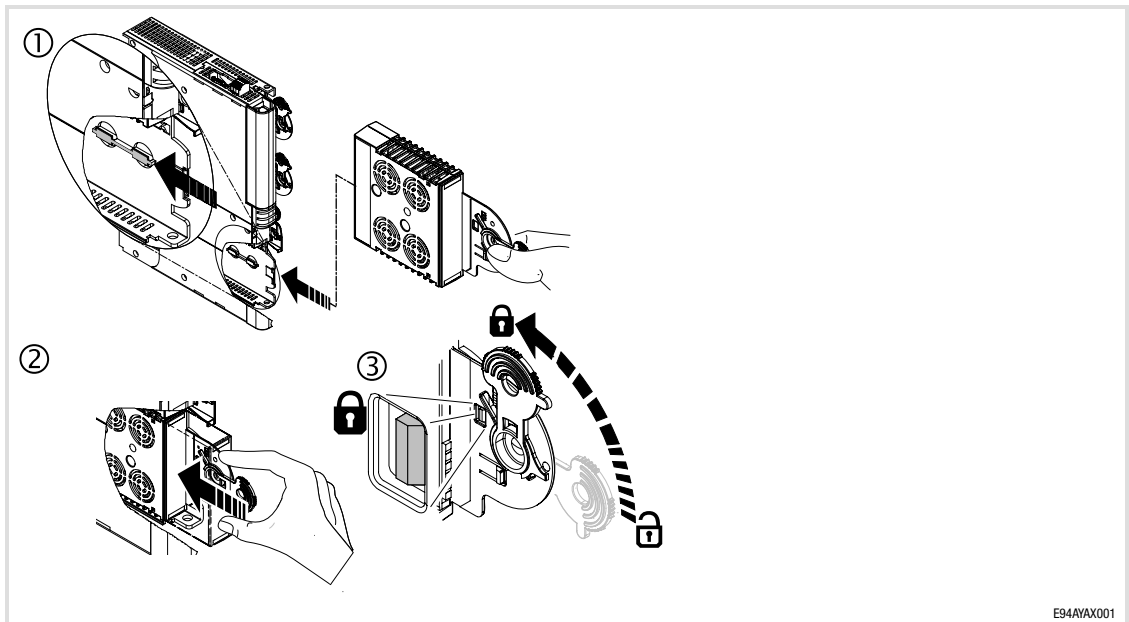

1.2.1.2 Dismounting

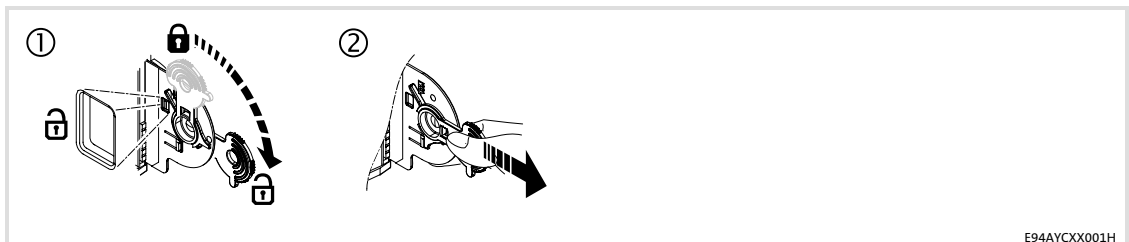

1.2.1.3 Module exchange



Stop!

Before mounting/dismounting, switch off the supply voltage to prevent electronic modules from damage.

Every module exchange is detected by the standard device and documented in a logbook. When a module is replaced by the same type, no restrictions arise. Depending on the module type it may be necessary to take further measures (e.g. address setting, safe parameter setting, ...).

When the module is replaced by a different type, the drive is inhibited by the controller. The inhibit can only be deactivated when the parameter setting of the required safety module complies with the plugged safety module.

Codes

Parameter: C00214	Name: Required safety module	Data type: UNSIGNED_8	Index: 24361 _d = 5F29 _h
-----------------------------	--	--------------------------	--

Setting of the expected safety module

- If a safety module deviating from this setting is detected, an error (fault) is caused. The error can only be removed by mains switching.

Selection list (Lenze setting bold)	Information
1 SM0	
2 SM100	
4 SM300	
5 SM301	

Read access Write access Controller inhibit PLC-STOP No transfer COM MOT



Note!

In case you exchange the module, the address switch **A** must be set identically to the module to be replaced. Only then the corresponding safe parameter set can be transferred to the module.

1.2.2 Function mode of the safety modules

C00214

The setting in C00214 must comply with the plug-in safety module type so that the controller is able to operate.

Disconnecting paths

The transmission of the pulse width modulation is safely disconnected by the safety module. Hence the drivers do not create a rotating field. The motor is safely switched to torqueless operation (STO).

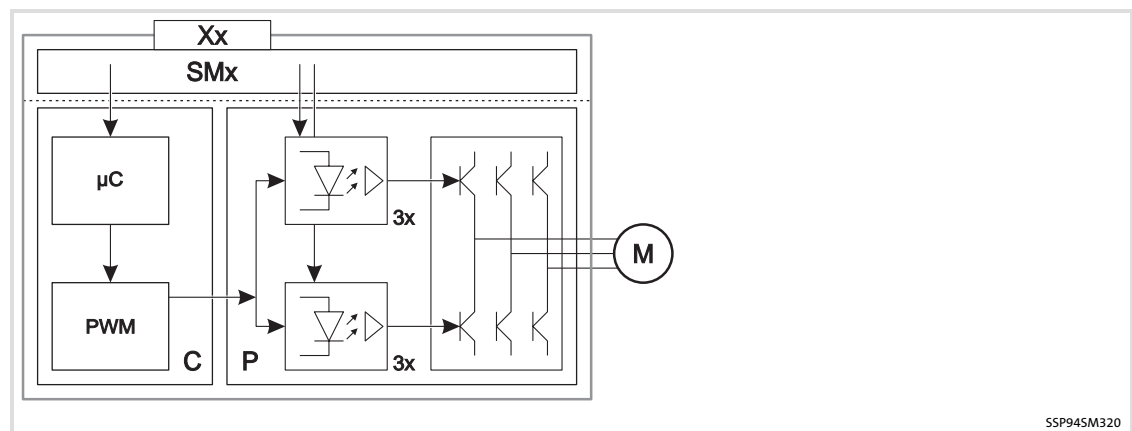

Fig. 1-1 Disconnecting paths of the safety modules

SMx	Safety module
xx	Input / output terminal
C	Control section
μC	Microcontroller
PWM	Pulse width modulation
P	Power section
M	Motor

Safety status

When the controller is switched off by the safety module, the controller switches to the "Safe torque off" device state.

- ▶ "Controller in STO state" is entered into the logbook (0x00750003).
- ▶ "Safe torque off active" is displayed in C00183.

Fail-safe status

**Note!**

If internal errors of the safety modules are detected, the motor is safely switched to torque-free operation (fail-safe status).

1.2.3 SM301 safety module

Validity information

These instructions are valid for

SM301 safety module		
Type	HW	SW
E94AYAE	from VA	from 01.00

Identification

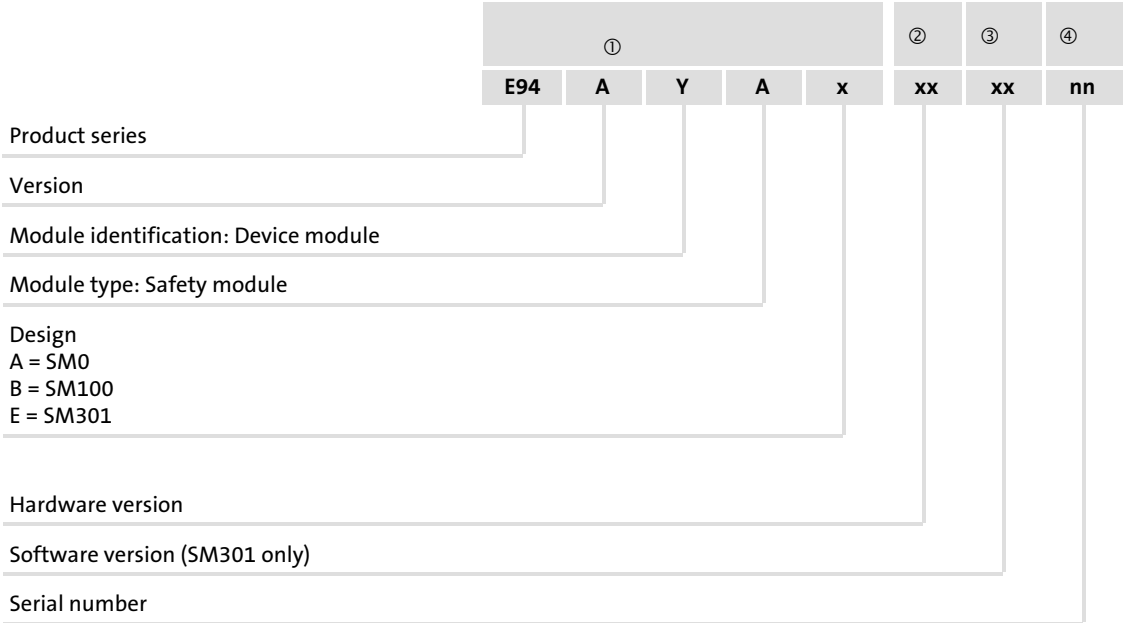
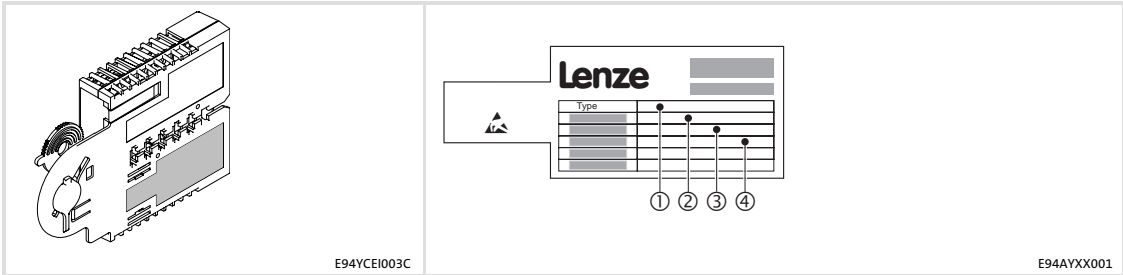

Application range

The use of this module is permissible with standard devices of the 9400 product series from nameplate designation

Type	HW	SW
E94AxHExxxx	VA	01.49
E94AxPExxxx	2A	02.xx

Safe position and speed detection with a resolver selected as the motor encoder and an additional position encoder is permissible with SM301 V1.3 and standard devices of the 9400 product series from nameplate designation

Type	HW	SW
E94AxHExxxx	xx	07.xx
E94AxPExxxx	2A	02.xx

Safe position and speed detection with a resolver selected as the motor encoder is permissible with SM301 V1.4 and standard devices of the 9400 product series from nameplate designation

Type	HW	SW
E94AxHExxxx	xx	08.xx
E94AxPExxxx	2A	02.xx

The use of this module is permissible with the PROFIBUS communication module from nameplate designation

Type	HW	SW
E94AYCPM	VB	01.10

This module as of SM301 V1.1 may be used in conjunction with the PROFINET communication module with the following nameplate data

Type	HW	SW
E94AYCER	VC	00.70

**Note!**

A safety bus system (PROFIsafe) can only be operated via the upper module slot (MXI1) of the Servo Drive 9400.

1.2.3.1 Overview

Functions

- ▶ Safe torque off (STO)
(formerly: Safe standstill, protection against unexpected start-up)
- ▶ Safe stop 1 (SS1)
- ▶ Safe stop 2 (SS2) - see SOS
- ▶ Safe stop emergency (SSE)
- ▶ Safe operational stop (SOS) - in accordance with EN 61800-5-2: SOS is designed with speed monitoring
- ▶ Safe maximum speed (SMS)
- ▶ Safely limited speed 1 (SLS1)
- ▶ Safe operation mode selector (OMS)
- ▶ Safe enable switch (ES)
- ▶ Safe speed monitor (SSM)
- ▶ Safe monitor (output)
- ▶ Connection of safety sensors
- ▶ Safe parameterisation
- ▶ Safety bus connection (PROFIsafe V1)

Additional functions from SM301 V1.1

- ▶ Safely limited speed 2 (SLS2)
- ▶ Safely limited speed 3 (SLS3)
- ▶ Safely limited speed 4 (SLS4)
- ▶ Safe cascading (CAS) via SD-In4/SD-Out1
- ▶ Safety bus connection (PROFIsafe V2)

Additional functions from SM301 V1.2

- ▶ Parameterisable response time of encoder monitoring

Additional functions from SM301 V1.3

- ▶ Safe operational stop (SOS) - compliant with EN 61800-5-2: SOS is designed with position monitoring
- ▶ Safe direction (SDI)
- ▶ Safe speed measurement and position detection with resolver using a motor encoder and an additional position encoder (two-encoder-concept)

Additional functions as of SM301 V1.4

- ▶ Safely limited increment (SLI)
- ▶ Safely monitored brake ramp for SS1/SS2
- ▶ Safe speed and position detection with resolver selected as the motor encoder

Motor-encoder combinations

Drive systems with Servo Drives 9400 and safety module SM301 provide speed-dependent safety functions for safe speed monitoring and/or safe relative-position monitoring. Observe permissible motor-encoder combinations during configuration.

► Possible speed-dependent safety functions with safety module SM301:

- Safe stop 1 (SS1)
- Safe operational stop (SOS)
- Safely limited speed (SLS)
- Safe maximum speed (SMS)
- Safe direction (SDI)
- Safe speed monitor (SSM)
- Safely limited increment (SLI)

► Permissible motor-encoder combinations for these functions:

Synchronous servo motors	Encoder		Safe speed monitoring with SM301	
	Type	Product key		
MCS 06 ... 19 MDXKS 56 / 71	Sin/cos absolute value, single-turn	AS1024-8V-H	Single-encoder concept	PL d / SIL 2
	Sin/cos absolute value, multi-turn	AM1024-8V-H		
	Resolver	RS0	Two-encoder concept	bis PL e / SIL 3

Asynchronous servo motors	Encoder		Safe speed monitoring with SM301	
	Type	Product key		
MCA 10 ... 26 MQA 20 ... 26	Sin/cos incremental	IG1024-5V-V	Single-encoder concept	PL e / SIL 3
	Resolver	RS0		PL d / SIL 2
	Two-encoder concept			bis PL e / SIL 3

Three-phase asynchronous motors	Encoder		Safe speed monitoring with SM301	
	Type	Product key		
MDxMA063-xx ... MDxMA225-xx MHxMA080-xx ... MHxMA225-xx	Sin/cos incremental	IG2048-5V-V	Single-encoder concept	PL e / SIL 3
MFxMA063-xx ... MFxMA132-xx				

A "two-encoder concept" includes e.g. a resolver as motor encoder and, at the same time, an absolute value encoder (sin/cos), an incremental encoder (TTL), or digital encoder (SSI/bus) as position encoder on the machine.

Compatibility

Compatibility of SM301/SM300

The SM301 safety module is compatible with the SM300. The controller needs to be adapted since the safe parameter set is required. Observe the following:

- ▶ The GSE file can be used.
- ▶ The PROFIsafe bits that are not used with SM300 must be suppressed in the SM301, since unset bits would activate safety functions.
- ▶ Speed-dependent functions cannot be used.

Compatibility of different SM301 versions

Replacement of an SM301 by an SM301 with a higher firmware version (SW):

- ▶ Every SM301 can be used with a safe parameter set of an elder firmware version without any changes.
- ▶ The safe parameter set including CRC in the memory module of the drive is not changed when the parameter set from the memory module is accepted.
- ▶ The CE Declaration of Conformity remains valid.
- ▶ The replacement of the safety module by an equivalent module is ensured. Thus, there is no need for spare part stockage of SM301 safety modules with elder firmware versions.
- ▶ Safe parameter sets of the "SM301 safety module" component can be loaded into an SM301 with a higher firmware version without any changes.
 - Extended functionalities of the newer firmware version cannot be selected and executed.

The safe parameter set of an SM301 with a newer firmware version cannot be loaded into an SM301 with an elder firmware version.

1.2.3.2 Safety category

The implemented safety functions meet the requirements of the standards:

- ▶ Control category 3 according to EN ISO 13849-1
In order to comply with category 3, the external wiring and cable monitoring must also meet the requirements of category 3.
- ▶ Performance Level (PL) "e" according to EN ISO 13849-1

1.2.3.3 Elements of the module

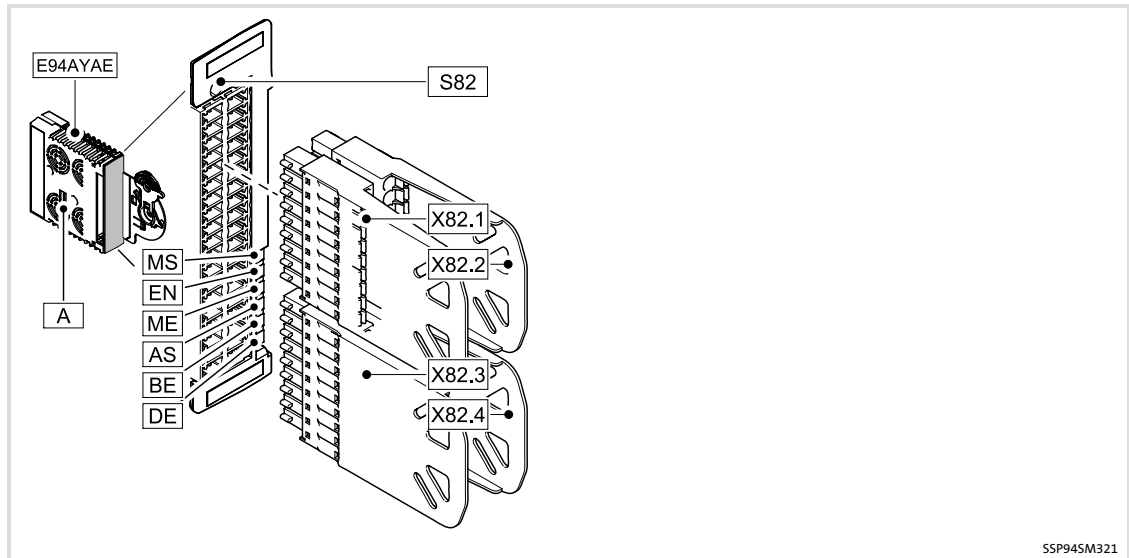

Fig. 1-2 Module view

Pos.	Description
A	Safety address switch (in the left part of the housing)
S82	Module switch for parameter set adoption from the memory module
X82.1	Plug-in terminal strips for input and output signals
X82.2	
X82.3	
X82.4	

Displays

Pos.	Colour	State	Description
MS (Module State)	Green	On	Drive-based safety has initialised without a fault.
		Blinking	Drive-based safety has initialised without a fault. Internal communication to the standard device is not possible.
		Flashing	Drive-based safety is in service status. For exiting, parameterise the drive-based safety.
		Off	Drive-based safety is not initialised. Acknowledgement is not possible.
EN (Enable)	Yellow	On	Controller enabled
		Off	Non-safe display "STO"
ME (Module Error)	Red	On	System error
		Blinking	Trouble
		Flashing	Warning
		Off	Error-free operation
AS (Acknowledge Stop)	Yellow	On	Request of an acknowledgement for the restart or the parameter set adoption
		Blinking	SS1/STO active
		Flashing	SS2/SOS active
		Off	No stop function active
BE (Bus Error)	Red	On	Safety bus error: <ul style="list-style-type: none"> • Communication is not possible. • Acknowledgement is possible.
		Blinking	Safety bus error: no valid configuration.
		Off	Safety bus: error-free operation.
DE (Drive Error)	Red	On	Drive-based safety is not accepted by the standard device (see notes in the instructions for the standard device).
		Off	Drive-based safety is correctly recognised by the standard device.

Blinking: on/off every 0.5 s Flashing: on/off every 0.1/0.9 s

Terminal assignment

**Danger!****Danger to life through improper installation**

Improper installation of the safety engineering systems can cause an uncontrolled starting action of the drives.

Possible consequences:

- ▶ Death or severe injuries

Protective measures:

Total cable length between X82 and its connected components (e.g. sensors, devices, ...) > 3 m:

- ▶ A shielded laying system must be used for the cable between X82 and its connected components:
 - The shield must at least cover the shield connection at the installation backplane.
 - The shield should also cover the connected component if possible.
- ▶ Unshielded wiring is permissible from hardware version 1A.

Total cable length between X82 and its connected components (e.g. sensors, devices, ...) < 3 m:

- ▶ Unshielded wiring is permissible.

X82.1	Labelling	Description
		This part of the terminal strip is not assigned.
	GO	GND SD-Out1
	O1B	Safe monitor SD-Out1, channel B
	O1A	Safe monitor SD-Out1, channel A
		This part of the terminal strip is not assigned.

X82.2	Labelling	Description
	-	GND external supply
	+	+24 V external supply via a safely separated power supply unit (SELV/PELV)
	GIR	This part of the terminal strip is reserved.
	RI1	
	GO	GND 24O
	24O	+24 V external supply for the safe monitor SD-Out1 (SELV/PELV)
	AIE	Error acknowledgement input ("Acknowledge In Error")
	CLA	Clock output for passive sensors, channel A (Clock A)
	CLB	Clock output for passive sensors, channel B (Clock B)

X82.3	Labelling	Description
	GCL	GND clock output
	GI2	GND SD-In2
	I2B	Sensor input SD-In2, channel B
	I2A	Sensor input SD-In2, channel A
	GCL	GND clock output
	GI1	GND SD-In1
	I1B	Sensor input SD-In1, channel B
	I1A	Sensor input SD-In1, channel A
	AIS	Restart acknowledgement input ("Acknowledge In Stop", 1-channel, bridged to X82.4/AIS)

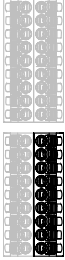
X82.4	Labelling	Description
	GCL	GND clock output
	GI4	GND SD-In4
	I4B	Sensor input SD-In4, channel B
	I4A	Sensor input SD-In4, channel A
	GCL	GND clock output
	GI3	GND SD-In3
	I3B	Sensor input SD-In3, channel B
	I3A	Sensor input SD-In3, channel A
	AIS	Restart acknowledgement input ("Acknowledge In Stop", 1-channel, bridged to X82.3/AIS)

Cable cross-sections and tightening torques				
Type	[mm ²]	[Nm]	AWG	[lb-in]
Wire end ferrule, insulated	0.25 ... 0.75	Spring terminal	24 ... 18	Spring terminal
Rigid	0.14 ... 1.5		26 ... 16	

Stripping length or contact length: 9 mm

Insulated wire end ferrules according to DIN 46228, part 4, 0.5 mm² or 0.75 mm² - length L1 = 10 mm can be used.



Note!

Provide for a sufficient strain relief, so that the terminals are not pulled from the plug connectors, in particular when you use rigid cables.

1 Safety engineering

Device modules
SM301 safety module

1.2.3.4 Technical data

24 V supply

The module and the safe output must be supplied with 24 V from safely separated power supply units. To maintain electrical isolations, separate voltage supplies are required.

Detailed features of the 24-V supply					
Terminal	Specification	[Unit]	min.	typ.	max.
+, -	Supply voltage of the module via a safely separated power supply unit (SELV/PELV)	[V]	19.2	24	30
	Input current	[mA]			350
24O, GO	Supply voltage of the safe output via a safely separated power supply unit (SELV/PELV)	[V]	18	24	30
	Input current	[mA]			1100

If the voltage of the SELV/PELV power supply unit can exceed 30 V in the event of an error, provide for an external fuse (☞ 1.1.8).

Inputs and output

The inputs and the output are isolated and designed for a low-voltage supply of 24 V DC. The digital inputs are protected against polarity reversal.

Detailed features of the safe inputs and the safe output					
Terminal	Specification	[Unit]	min.	typ.	max.
I1A, I1B	PLC input, IEC-61131-2, 24 V, type 1				
I2A, I2B	Low signal input voltage	V	-3	0	5
I3A, I3B	Input current at low signal	mA			15
I4A, I4B	High signal input voltage	V	15	24	30
AIE, AIS	Input current at high signal	mA	2		15
	Input capacitance	nF			3.5
	Repetition rate of the test pulses	ms	50		
AIE, AIS	Input delay (operating time)	s	0.3		10
CLA, CLB	PLC output, IEC-61131-2, 24 V DC, 50 mA				
	Low signal output voltage	V		0	0.8
	High signal output voltage	V	17	24	30
	Output current	mA			60
	Cable capacity	nF			100
	Cable resistance of a passive sensor	Ω			200
O1A, O1B	PLC output, IEC-61131-2, 24 V DC				
	Low signal output voltage	V		0	0.8
	High signal output voltage	V	17	24	30
	Output current	mA			500
	Cable capacity	nF			100
	Cable resistance	Ω			200

Tab. 1-1 Technical data

The chapter "Response times" must be observed as well (☞ 1.8).

1.2.3.5 Example circuit

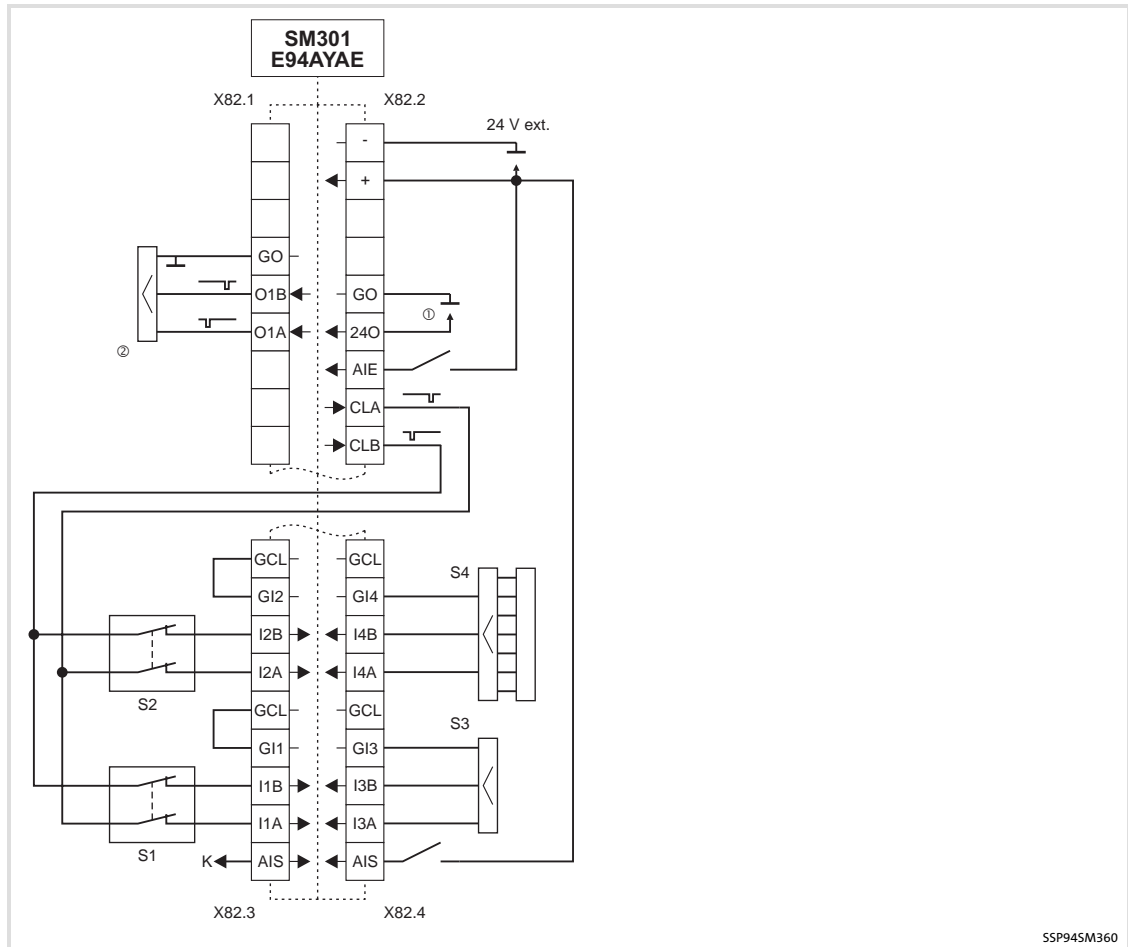

Fig. 1-3 Wiring example

E94AYAE	SM301 safety module
S1	passive sensor with channel A and B
S2	passive sensor with channel A and B
S3	higher-level safety control (active sensor)
S4	lightgrid (active sensor)
24 V ext.	24-V voltage supply of the module (SELV/PELV)
①	24-V voltage supply of the output (SELV/PELV)
②	safe output to higher-level safety control
K	to AIS of the next module

1 Safety engineering

Device modules

SM301 safety module

1.2.3.6 Commissioning

- ▶ For commissioning and safe parameter setting, the Lenze »Engineer« PC software from version 1.4 must be used.
If you select the safety module in the *Project view*, various tabs are available in the *Operating range* via which the safety module can be parameterised. In all other program parts the parameters of the safety module can only be read. Thus, the write access of these parameters (codes) is marked with .
- ▶ Settings in or at the module:
 - Safety address
 - Safe parameter setting of the functions to be used
- ▶ Required settings in the standard device:
 - C00214, type of safety module
 - Implementation of the SM301 into the drive application by evaluating the control information and status information.
- ▶ During commissioning and after the replacement of a module it is vital to check the safety function. Additional information contains the "Acceptance" chapter. (📖 109).

1.2.3.7 Test certificate

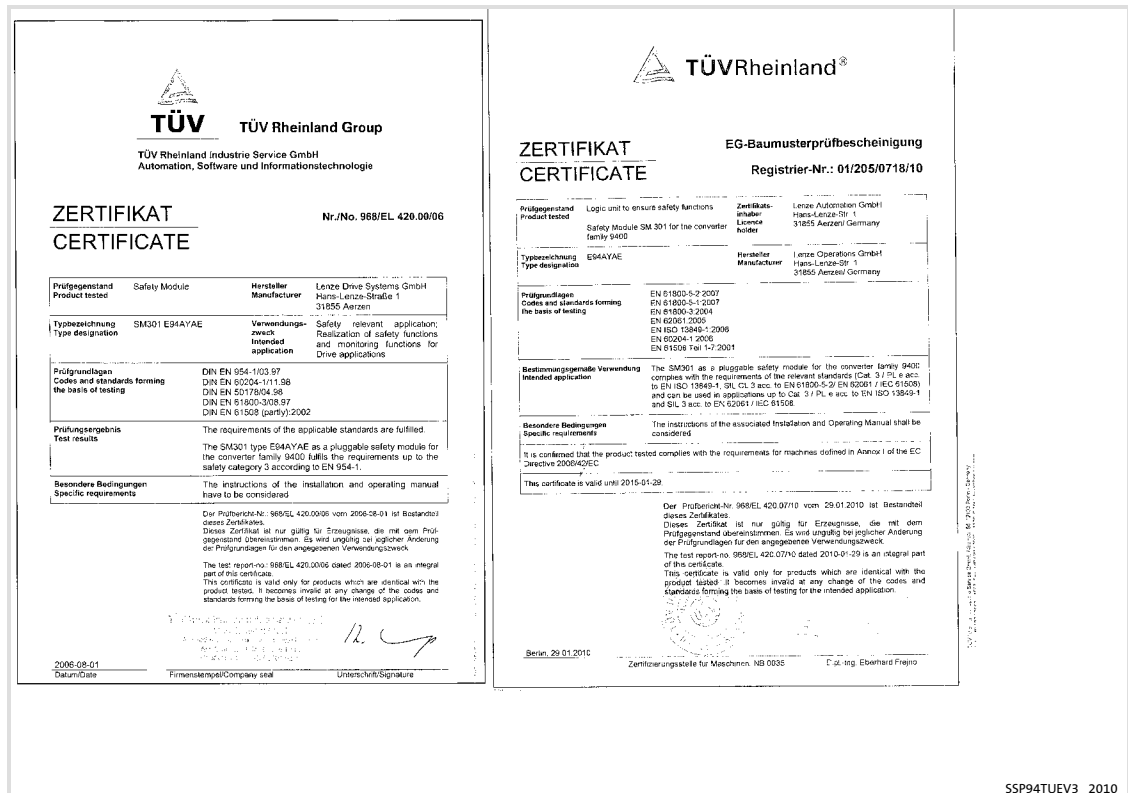

Fig. 1-4 TÜV Certificate

The type test was carried out by 'TÜV Rheinland (Group)' and confirmed with a certificate.

► SM301 V1.0

Contents	Specifications
Test institute	TÜV Rheinland Industrie Service GmbH, ASI range
Test report	968/EL 420.00/06
Test fundamentals	EN 954-1, EN 60204-1, EN 50178, EN 61800-3, IEC 61508 Part 1-7
Object to be examined	SM301, type E94AYAE VA1.0x of the 9400 Servo Drives series
Test result	The module meets the requirements according to EN 954-1, category 3.
Special conditions	The safety instructions in the corresponding user documentation must be observed.
Place of issue	Cologne
Issue date	01.08.2006

► from SM301 V1.1

Contents	Specifications
Test institute	TÜV Rheinland Industrie Service GmbH, ASI range
Test report	968/EL 420.03/07
Test fundamentals	EN 954-1, EN 60204-1, EN 50178, EN 61800-3, EN 61508 Part 1-7, EN ISO 13849-1, EN 62061
Object to be examined	SM301, type E94AYAE VB1.1x of the 9400 Servo Drives series
Test result	The module meets the requirements according to <ul style="list-style-type: none"> ● EN 954-1, category 3 ● EN 61508, SIL 3 ● EN ISO 13849-1, PL e
Special conditions	The safety instructions in the corresponding user documentation must be observed.
Place of issue	Cologne
Issue date	08.05.2007

► from SM301 V1.2

Contents	Specifications
Test institute	TÜV Rheinland Industrie Service GmbH, ASI range
Test report	968/EL 420.04/07
Test fundamentals	EN 954-1, EN 60204-1, EN 50178, EN 61800-3, EN 61508 Part 1-7, EN ISO 13849-1, EN 62061
Object to be examined	SM301, type E94AYAE of the Servo Drives 9400 series
Test result	The module meets the requirements according to <ul style="list-style-type: none"> ● EN 954-1, category 3 ● EN 61508, SIL 3 ● EN ISO 13849-1, category 3/PL e
Special conditions	The safety instructions in the corresponding user documentation must be observed.
Place of issue	Cologne
Issue date	18.10.2007

► from SM301 V1.3

Contents	Specifications
Test institute	TÜV Rheinland Industrie Service GmbH, ASI range
Test report	968/EL 420.07/10
Certification body	NB 0035
Registration no.	01/205/0718/10
Test fundamentals	EN 60204-1, EN 61800-3, EN 61508 Part 1-7, EN ISO 13849-1, EN 62061, EN 61800-5-2, EN 61800-5-1
Object to be examined	SM301, type E94AYAE of the Servo Drives 9400 series
Test result	The module meets the requirements according to <ul style="list-style-type: none"> ● EN 61508, SIL 3 ● EN ISO 13849-1, category 3/PL e
Special conditions	The safety instructions in the corresponding user documentation must be observed.
Place of issue	Berlin
Issue date	29.01.2010
Valid until	29.01.2015

► from SM301 V1.4

Contents	Specifications
Test institute	TÜV Rheinland Industrie Service GmbH, ASI range
Test report	968/EL 420.08/10
Test fundamentals	EN 60204-1, EN 61800-3, EN 61508 Part 1-7, EN ISO 13849-1, EN 62061, EN 61800-5-2, EN 61800-5-1
Object to be examined	SM301, type E94AYAE of the Servo Drives 9400 series
Test result	The module meets the requirements according to <ul style="list-style-type: none"> ● EN 61508, SIL 3 ● EN ISO 13849-1, category 3/PL e
Special conditions	The safety instructions in the corresponding user documentation must be observed.
Place of issue	Cologne
Issue date	11.10.2010

1 Safety engineering

Device modules
Safe inputs

1.2.4 Safe inputs

1.2.4.1 General

The following applies to the sensors at the SM301 V1.0:

- ▶ Sensor type and sensor function can be parameterised in C15030, C15031 and C15032.
- ▶ A local evaluation is executed if corresponding parameters are set.
- ▶ If a safety bus is activated, the sensor signals are sent as status information to the higher-level control.
- ▶ Deactivated sensor inputs must not be connected. The status of a non-connected input is in the OFF state.
- ▶ If a signal is detected at deactivated sensor inputs during initialisation, the drive remains inhibited (STO).
- ▶ Faulty inputs are assessed as OFF state.

Additional conditions for SM301 V1.1:

- ▶ With active cascading in C15035 the SD-In4 input cannot be used freely anymore.

Codes

Parameter:	Name:	Data type:	Index:
C15030	SD-In sensor type	UNSIGNED_8	9545 _d = 2549 _h

Configuration of the sensor types which are connected to the safe inputs.

Selection list (Lenze setting bold)	Information
0 Input deactivated	
1 Passive sensor	
2 Active sensor	

Subcodes	Information
C15030/1	SD-In1 sensor type
C15030/2	SD-In2 sensor type
C15030/3	SD-In3 sensor type
C15030/4	SD-In4 sensor type

Read access Write access Controller inhibit PLC-STOP No transfer

Parameter:	Name:	Data type:	Index:
C15031	SD-In sensor function	UNSIGNED_8	9544 _d = 2548 _h

Function configuration of the safe inputs.

- The "operation mode selector" and "enable switch" functions may only be assigned to one of the four safe inputs.

Selection list (Lenze setting printed in bold)	Information
0 Free assignment	Safety function set in C15032
1 Emergency stop	Safe stop emergency function (SSE)
2 Operation mode selector	Safe operation mode selector (OMS)
3 Enable switch	Safe enable switch (ES)

Subcodes	Information
C15031/1	SD-In1 sensor function
C15031/2	SD-In2 sensor function
C15031/3	SD-In3 sensor function
C15031/4	SD-In4 sensor function

Read access Write access Controller inhibit PLC-STOP No transfer

Parameter: C15032	Name: SD-In free assignment	Data type: UNSIGNED_8	Index: 9543 _d = 2547 _h
-----------------------------	---------------------------------------	--------------------------	---

Assignment of a safety function to a safe input.

- Only possible if the "free assignment" sensor function is set for the safe input in C15031.

Selection list (Lenze setting printed in bold)	Information
0 STO	Safe torque off
1 SS1	Safe stop 1
2 SS2	Safe stop 2
3 SLS1	Safely limited speed 1
4 SLS2	Safely limited speed 2 (from SM301 V1.1)
5 SLS3	Safely limited speed 3 (from SM301 V1.1)
6 SLS4	Safely limited speed 4 (from SM301 V1.1)
7 SDlpos	Safe positive direction (from SM301 V1.3)
8 SDlneg	Safe negative direction (from SM301 V1.3)
9 No function	No (local) safety function assigned. <ul style="list-style-type: none"> ● Functional test and monitoring of the discrepancy time are active. ● The input status is transferred to the control via the safety bus (if parameterised).
Subcodes	Information
C15032/1	Free assignment SD-In1
C15032/2	Free assignment SD-In2
C15032/3	Free assignment SD-In3
C15032/4	Free assignment SD-In4

Read access Write access Controller inhibit PLC-STOP No transfer

Parameter: C15205	Name: SSE: Safe stop emergency function	Data type: UNSIGNED_8	Index: 9370 _d = 249A _h
-----------------------------	---	--------------------------	---

Selection of the stop function for emergency stop

Selection list (Lenze setting printed in bold)	Information
0 STO	Safe torque off
1 SS1	Safe stop 1

Read access Write access Controller inhibit PLC-STOP No transfer

Specification	Sensor type	
	passive	active
Discrepancy time	parameterisable 0 ... 30000 ms (increment: 2 ms)	
Input delay	parameterisable 0 ... 100 ms (increment: 2 ms)	
Input filter time for test pulses	fixed 2 ms	
Repetition rate of the test pulses	is determined by the clock outputs CLA and CLB	> 50 ms
Error response	Sensor input is assessed as OFF state. Acknowledgement via safety bus or AIE input	

Tab. 1-2 Specification of sensor connections

Explanations

► Discrepancy time

Maximum time in which both channels of a safe input may have non-equivalent states without the safety engineering causing an error response.

► Input delay

Time between the recognition of the signal change and the effective evaluation of an input signal. As a result, multiple and short signal changes due to contact bounce of the components are not taken into account.

► Input filter time

Time in which the interference pulses and test pulses are not detected by e.g. active sensors that are switched on.

The input delay time and the time of the input filters influence the response time. More information can be found in the "Response times" chapter (📖 106).

Codes

Parameter:	Name:	Data type:	Index:
C15033	SD-In discrepancy time	UNSIGNED_16	9542 _d = 2546 _h
Maximum time in which both channels of a safe input may have non-equivalent states without the safety engineering causing an error response.			
Setting range (min. value unit max. value)		Information	
0	MS	30000	Lenze: 10, increment: 2 ms
Subcodes		Information	
C15033/1			SD-In1 discrepancy time
C15033/2			SD-In2 discrepancy time
C15033/3			SD-In3 discrepancy time
C15033/4			SD-In4 discrepancy time
<input checked="" type="checkbox"/> Read access <input checked="" type="checkbox"/> Write access <input type="checkbox"/> Controller inhibit <input type="checkbox"/> PLC-STOP <input type="checkbox"/> No transfer			

Parameter: C15034	Name: SD-In input delay	Data type: UNSIGNED_8	Index: 9541 _d = 2545 _h
Time between the recognition of the signal change and the effective evaluation of an input signal. As a result, multiple and short signal changes due to contact bounce of the components are not taken into account.			
Setting range (min. value unit max. value)		Information	
0	MS	100	Lenze: 0, increment: 2 ms
Subcodes		Information	
C15034/1		Input delay SD-In1	
C15034/2		Input delay SD-In2	
C15034/3		Input delay SD-In3	
C15034/4		Input delay SD-In4	
<input checked="" type="checkbox"/> Read access <input checked="" type="checkbox"/> Write access <input type="checkbox"/> Controller inhibit <input type="checkbox"/> PLC-STOP <input type="checkbox"/> No transfer			

Contact function test



Note!

Make sure that an internal contact function test is carried out at the safe inputs:

Safe input in the ON state

- ▶ A LOW level at **one channel** puts the input in the OFF state. The discrepancy monitoring starts simultaneously.
- ▶ A LOW level must be detected at **both channels** within the discrepancy time, otherwise a discrepancy error will be reported.
- ▶ To be able to acknowledge the discrepancy error, a LOW level must be detected before at **both channels**.

Safe input in the OFF state

- ▶ A HIGH level at **one channel** starts the discrepancy monitoring.
- ▶ A HIGH level must be detected at **both channels** within the discrepancy time, otherwise a discrepancy error will be reported.
- ▶ To be able to acknowledge the discrepancy error, a HIGH level must be detected before at **both channels**.

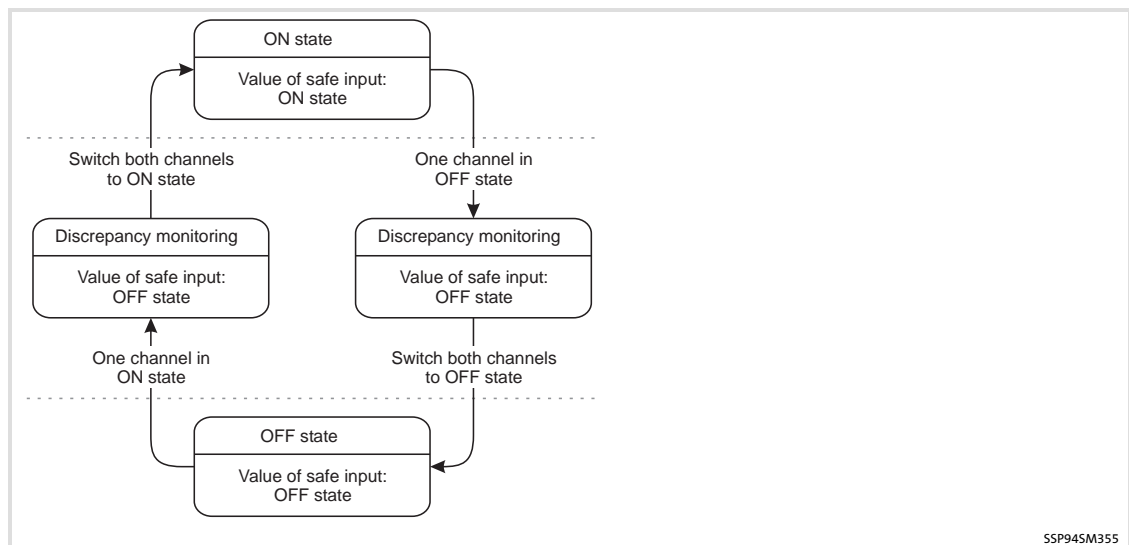

Fig. 1-5 Status behaviour - contact function test

SSP945M355

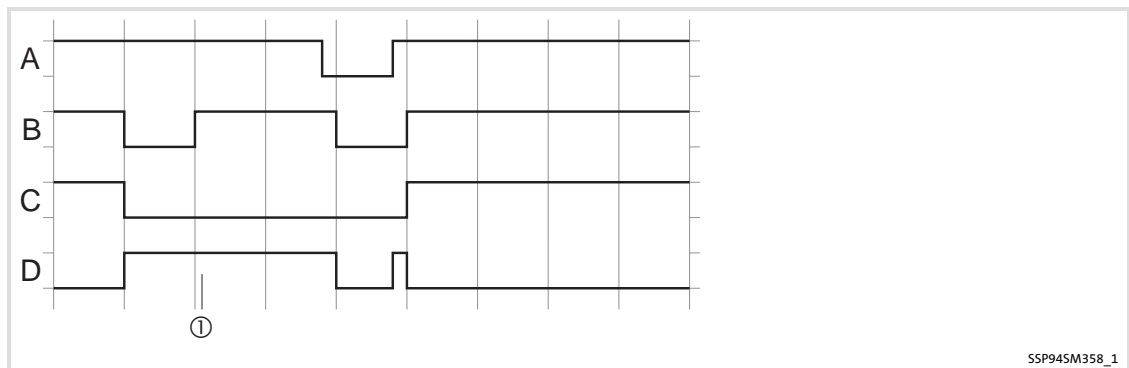

Fig. 1-6 Contact function test - error-free input signals

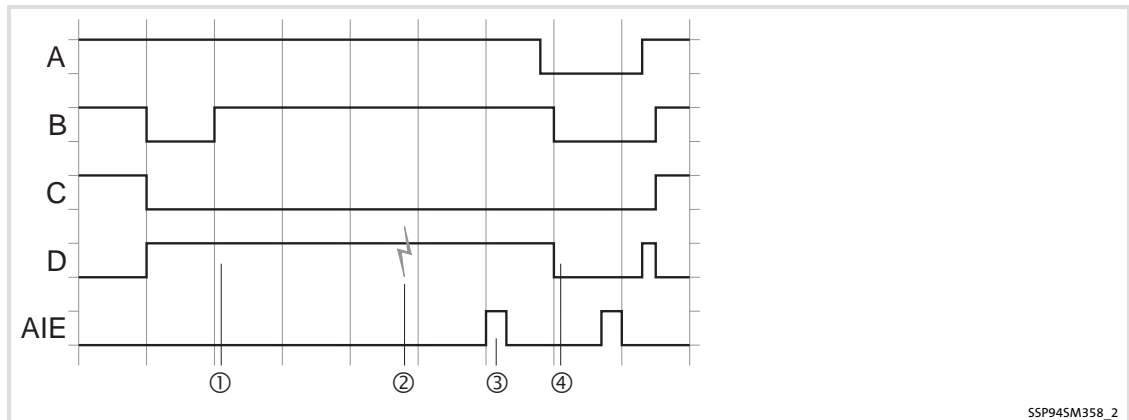

Fig. 1-7 Contact function test - faulty input signals

- | | |
|------|--------------------------------------|
| A, B | Safe input, channel A and channel B |
| C | Internal valuation of the safe input |
| D | Discrepancy monitoring |
| AIE | Fault acknowledgement |
| ① | Discrepancy monitoring active |
| ② | Discrepancy monitoring - time-out |
| ③ | Fault acknowledgement impermissible |
| ④ | Fault acknowledgement permissible |

1.2.4.2 Connection of passive sensors

The safe sensor inputs I1A ... I4B are suitable for **equivalently switching** passive sensors. To monitor passive sensors according to EN ISO 13849-1, cat. 3, the clock outputs CLA and CLB must be wired. Please observe the following:

- ▶ The clock outputs are only suitable for monitoring the passive sensors.
- ▶ Always connect ...
 - ... CLA to IxA (channel A of the sensor input) via the sensor.
 - ... CLA to IxB (channel B of the sensor input) via the sensor.
 - ... GCL with GIx of the sensor input.
- ▶ The sensor inputs are tested cyclically through short LOW operation.
 - The A and B channels are tested at different times in cycles of approx. 2 s, with test pulses of < 1 ms.

These errors are detected:

- ▶ Short circuit to supply voltage.
- ▶ Short circuit between the input signals when different clock outputs are used.
- ▶ Non-equivalent input signals after the discrepancy time.

These errors are not detected:

- ▶ Short circuit between the input signals when the same clock outputs are used.

Avoid unrecognisable errors by the installation, e.g. by separated cable routing.

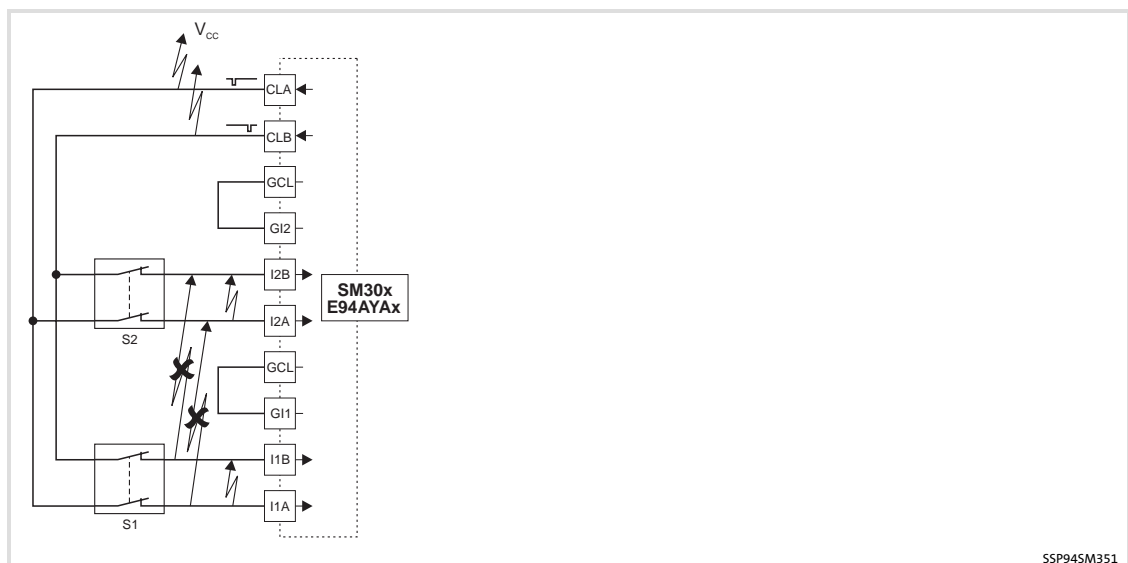

Fig. 1-8 Ways to detect errors
x Unrecognisable errors

1 Safety engineering

Device modules
Safe inputs

1.2.4.3 Connection of active sensors

The safe sensor inputs I1A ... I4B are suitable for active sensors.

PN-switched input signals are permissible.

The line monitoring must comply with the requirements of the category 3. Drive-based safety does not provide for line monitoring.

These errors are detected:

- ▶ Non-equivalent input signals after the discrepancy time.

1.2.4.4 Example circuits

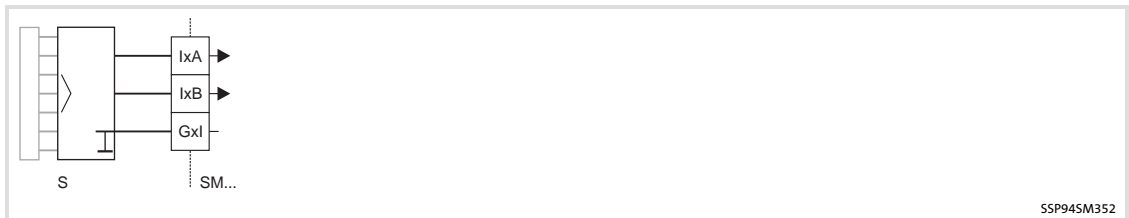

Fig. 1-9 Example circuit - active sensor

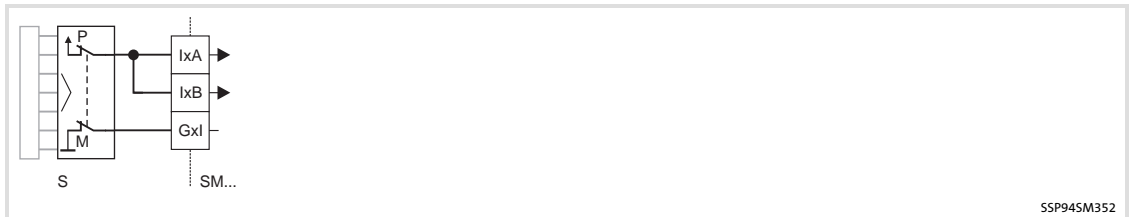

Fig. 1-10 Functional example of PN-switching sensor

S	Sensor
P	Positive path
M	Negative path

1.2.5 Safe output

1.2.5.1 General

Via the safe output O1A/O1B information can be output to a higher-level unit (e.g. safety PLC) or external switching elements (actuators) can be controlled.

The feedback output is potential-free and must be supplied separately with 24 V.

- ▶ The status of the safe output is controlled via two ways:
 - directly from the safety module (parameter setting required)
 - via the PROFIsafe output data
- ▶ The safe output is PP switching, i.e. two plus channels are switched.
- ▶ The safe output in ON state is cyclically tested by quick LOW switching.
 - The A and B channels are tested at different times in cycles of approx. 2 s, with test pulses of < 1 ms.
 - When selecting the downstream control elements, ensure that the test pulses will not be detected as LOW signal.

These errors will be detected and set the output to OFF state:

- ▶ Short circuit to supply voltage.
- ▶ In the ON state: Short circuit between the output signals.
- ▶ IN the OFF state: Missing 24-V supply voltage at the terminal 24O is detected as "Stuck-at-Low" error.

These errors are not detected:

- ▶ In the OFF state: short circuit between the output signals.

The output can be assigned multiple feedback information by parameter setting:

- ▶ Status of the safety function
- ▶ Information on error responses

The code C15060 contains information on the status of the feedback output.

Additional conditions for SM301 in VB 1.1 version:

- ▶ With active cascading in C15035 the SD-Out1 output cannot be used freely anymore.

Codes

Parameter:	Name:	Data type:	Index:
C15051	SD-Out condition	BITFIELD_32	9524 _d = 2534 _h
Bit coded selection of the conditions for switching the safe output.			
Value is bit coded:		Information	
Bit 0	STO active	Safe torque off	
Bit 1	STO active neg. logic		
Bit 2	SS1 active	Safe stop 1	
Bit 3	SS1 active neg. logic		
Bit 4	SS2 active	Safe stop 2	
Bit 5	SS2 active neg. logic		
Bit 6	SLS1 active	Safely limited speed 1	
Bit 7	SLS1 active neg. logic		
Bit 8	SLS2 active	Safely limited speed 2 (From SM301 V1.1)	
Bit 9	SLS2 active neg. logic		
Bit 10	SLS3 active	Safely limited speed 3 (From SM301 V1.1)	
Bit 11	SLS3 active neg. logic		
Bit 12	SLS4 active	Safely limited speed 4 (as of SM301 V1.1)	
Bit 13	SLS4 active neg. logic		
Bit 14	SDIpos is active	Safe direction, positive (From SM301 V1.3)	
Bit 15	SDIpos active neg. logic		
Bit 16	SDIneg is active	Safe direction, negative (From SM301 V1.3)	
Bit 17	SDIneg active neg. logic		
Bit 18	ES active	Safe enable switch	
Bit 19	ES active neg. logic		
Bit 20	SLI is active	Safely limited increment (From SM301 V1.4)	
Bit 21	SLI active neg. logic		
Bit 22	OMS	Safe operation mode selector	
Bit 23	OMS neg. logic		
Bit 24	Reserved		
...			
Bit 31	Reserved		
Subcodes		Information	
C15051/1		SD-Out1 switching condition	
<input checked="" type="checkbox"/> Read access <input checked="" type="checkbox"/> Write access <input type="checkbox"/> Controller inhibit <input type="checkbox"/> PLC-STOP <input type="checkbox"/> No transfer			

Parameter: C15052	Name: SD-Out condition	Data type: BITFIELD_32	Index: 9523 _d = 2533 _h
-----------------------------	----------------------------------	---------------------------	---

Bit coded selection of the conditions for switching the safe output.

Value is bit coded:	Information
Bit 0 SOS monitored	Safe operational stop is monitored.
Bit 1 SOS monitors neg. logic	Safe operational stop is not monitored.
Bit 2 SLS1 monitored	Safely limited speed 1 is monitored.
Bit 3 SLS1 monitored neg. logic	Safely limited speed 1 is not monitored.
Bit 4 SLS2 monitored	Safely limited speed 2 is monitored. (from SM301 V1.1)
Bit 5 SLS2 monitors neg. logic	Safely limited speed 2 is not monitored. (from SM301 V1.1)
Bit 6 SLS3 monitored	Safely limited speed 3 is monitored. (from SM301 V1.1)
Bit 7 SLS3 monitors neg. logic	Safely limited speed 3 is not monitored. (from SM301 V1.1)
Bit 8 SLS4 monitored	Safely limited speed 4 is monitored. (from SM301 V1.1)
Bit 9 SLS4 monitors neg. logic	Safely limited speed 4 is not monitored. (from SM301 V1.1)
Bit 10 SDlpos monitored	Safe positive direction is monitored. (from SM301 V1.3)
Bit 11 SDlpos monitors neg. logic	Safe positive direction is not monitored. (from SM301 V1.3)
Bit 12 SDlneg monitored	Safe negative direction is monitored. (from SM301 V1.3)
Bit 13 SDlneg monitors neg. logic	Safe negative direction is not monitored. (from SM301 V1.3)
Bit 14 SSE active	Emergency stop function
Bit 15 SSE active neg. logic	
Bit 16 SD-In1 active	Safe inputs
Bit 17 SD-In1 active neg. logic	
Bit 18 SD-In2 active	
Bit 19 SD-In2 active neg. logic	
Bit 20 SD-In2 active	
Bit 21 SD-In2 active neg. logic	
Bit 22 SD-In4 active	
Bit 23 SD-In4 active neg. logic	
Bit 24 Reserved	
Bit 25 Reserved	
Bit 26 OMS active	Special operation is active (from SM301 V1.1)
Bit 27 OMS active neg. logic	Special operation is not active (from SM301 V1.1)
Bit 28 Reserved	
Bit 29 Reserved	
Bit 30 Error active	
Bit 31 Error active neg. logic	

Subcodes	Information
C15052/1	SD-Out1 switching condition

Read access Write access Controller inhibit PLC-STOP No transfer

Parameter: C15055	Name: SD-Out logic function	Data type: UNSIGNED_8	Index: 9520 _d = 2530 _h
-----------------------------	---------------------------------------	--------------------------	---

Selection of the logic operation for the switching conditions to be evaluated

Selection list (Lenze setting bold)	Information
0 OR	
1 AND	

Subcodes	Information
C15055/1	SD-Out1 logic function

Read access Write access Controller inhibit PLC-STOP No transfer

Parameter:	Name:	Data type:	Index:
C15060	Output image	BITFIELD_16	9515 _d = 252B _h

Output image of the safety module feedback, shown in channels.

Value is bit coded:	Information
Bit 0 SD-Out1 channel A	Safe output 1
Bit 1 SD-Out1 channel B	
Bit 2 reserved	
...	
Bit 15 reserved	

Read access
 Write access
 Controller inhibit
 PLC-STOP
 No transfer

1.2.5.2

Example circuits

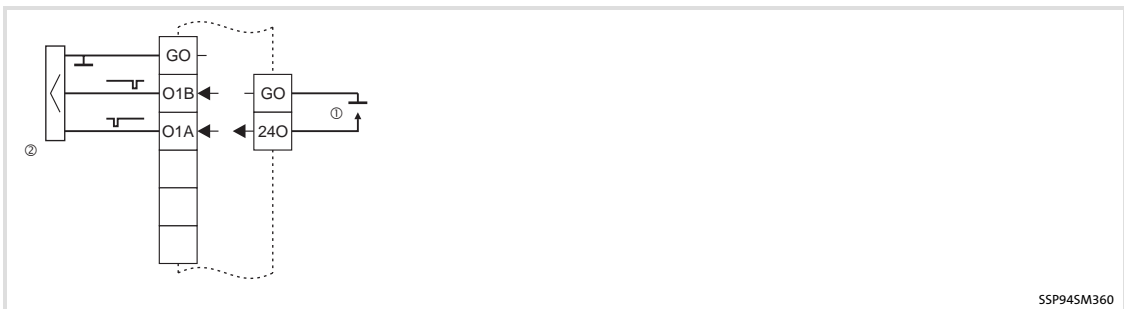

- 240, GO 24-V voltage supply for the safe output
- O1A, O1B, GO Safe output SD-Out1, channel A and B with reference potential
- ① 24-V voltage supply - safe output (SELV/PELV) acc. to IEC 61131-2
- ② Input of a higher-level unit (e.g. safety PLC)

SSP945M360

1.2.6 Further inputs

AIS input

The restart (when setting "acknowledged restart", (📖 50)), after a stop function has been executed, requires an acknowledgement at AIS input:

- ▶ Positive signal pulse of 0.3 ... 10 s (terminal X82.3 or X82.4).
 - Evaluation of the negative edge.

Other equivalent option:

- ▶ Signal via the PROFIsafe bit PS_AIS (if communication via safety bus is preferred)
 - Evaluation of the positive edge.

AIE input

Errors require an acknowledgement at AIE input:

- ▶ Positive signal pulse of 0.3 ... 10 s (terminal X82.2).
 - Evaluation of the negative edge.

Other equivalent option:

- ▶ Signal via the PROFIsafe bit PS_AIE (if communication via safety bus is preferred)
 - Evaluation of the positive edge.

1 Safety engineering

Device modules

Safe speed measurement and position detection

1.2.7 Safe speed measurement and position detection

For a safe speed and position detection, you must connect a safety-approved sin/cos encoder to terminal X8 (Sub-D).

Alternatively, you can connect a 2-encoder system, consisting of motor encoder and position encoder from SM301 V1.3. When selecting a 2-encoder system, you can also select a resolver as motor encoder.

From SM301 V1.4, the resolver can be selected as the motor encoder without needing an additional position encoder. The response time of the encoder monitoring must be set to 50 ms or 100 ms.

Safe speed measurement				
Motor encoder system	Max. speed [rpm]	Synchronism [%]	Response time of encoder monitoring [ms]	Error response
Encoder	± 16000	1	12 From SM301 V1.2: 12/50/100 can be parameterised (☐ 1.8.4)	Error stop STO
Resolver	± 10000 / no. of resolver pole pairs	1	From SM301 V1.3: 12/50/100 can be parameterised (☐ 1.8.4)	

Tab. 1-3 Detailed features

Explanations on the data:

- ▶ Synchronism
Fluctuation of the detected speed at constant input signal.
- ▶ Response time of encoder monitoring
Time required to detect faults due to continuous signal errors at the encoder interface.
- ▶ Tolerance of speed monitoring
Time required to detect ... faults.



Note!

If speed monitoring is active and the standard device detects the inverter error characteristic (C00002=71) or determines the motor parameters (C00002=72), the error message "Safe speed invalid" is displayed. Both functions cannot be completed since the SM301 activates STO. These two states generally occur only once during commissioning.

Therefore, these functions should be carried out before the speed monitoring is activated in the SM301.

A plausibility check regarding the speed detected from the standard device and the safety module takes place. The maximum deviation allowed (after a filter time of approx. 2 seconds) is set to a limited value of 20 rpm up to SM301 V1.2. The filter time of approx. 2 s belongs to the diagnosis function and is independent of the response time. From SM301 V1.3, this tolerance limit can be parameterised (C15411).

**Note!**

As safe speed, the higher value which results from the comparison of the dual-channel speed information is used.

The value "Tolerance - speed comparison" must be selected as low as possible. If a speed/position information fails during operation, this must be detected by the diagnostic function. It is thus required to exceed the value "Tolerance - speed comparison" for at least more than two seconds during operation to ensure the dual-channel redundancy of the encoder information. A too low value can cause a restricted plant availability.

The speed-dependent and/or direction-of-rotation dependent functions require information from safe speed measurement. These are the functions:

- ▶ Safe stop 2 (SS2)
- ▶ Safe operational stop (SOS)
 - Following EN 61800-5-2: SOS is designed with speed monitoring (SM301 V1.2)
 - In compliance with EN 61800-5-2: SOS is designed with position monitoring (From SM301 V1.3)
- ▶ Safe maximum speed (SMS)
- ▶ Safely limited speed (SLS)
- ▶ Safe speed monitor (SSM)
- ▶ Safe direction (SDI) (From SM301 V1.3)
- ▶ Safely limited increment (SLI) (From SM301 V1.4)

The dependent functions must not be parameterised when "No encoder system" is set. The plausibility check rejects such ambiguous settings until you have parameterised them correctly.

**Tip!**

The motor encoder position and, if required, position encoder position are 32-bit values in the safety module. The lower-order 16 bits contain the part of a motor revolution and the higher-order 16 bits contain the multiple of a motor revolution. Examples:

1/4 motor revolution	65536/4	16384	/	0x0000'4000
1/2 motor revolution	65536/2	32768	/	0x0000'8000
1 motor revolution	65536/1	65536	/	0x0001'0000
2 motor revolutions	2*65536	131072	/	0x0002'0000

Parameter setting of standard device 9400		→	Parameter setting of SM301	
Motor mounting direction C02527/0	Position encoder mounting direction C02529/0		Motor mounting direction C15409/0	Position encoder mounting direction C15502/0
CW	CW	→	CW	"Like motor encoder"
CW	CCW	→	CW	"Inverted ..."
CCW	CW	→	CCW	"Inverted ..."
CCW	CCW	→	CCW	"Like motor encoder"

Tab. 1-4 Overview of dependency of the parameterisation from the mounting direction



Stop!

Malfunctions due to slip, shaft fracture etc.

Slip, shaft fracture etc. between motor and encoder system disturb the safe speed measurement.

Possible consequences:

- ▶ The speed-dependent and/or direction-of-rotation dependent functions are executed incorrectly.

Protective measures:

- ▶ Prevent malfunctions by constructive measures.
- ▶ Use the motors and encoder systems with guaranteed features. Your Lenze contact partner helps you to find suitable systems.
- ▶ In the event of service, this must also be observed for the motor or the encoder system.

Single-encoder concepts with resolvers

Please observe during the configuration of such systems:

If only one feedback system is used in connection with these safety applications, the applicable safety standard, IEC 61800-5-2 (Adjustable speed electrical power drive systems, Part 5-2: Safety requirements - Functional), poses special requirements for the connection between feedback system and motor shaft. This is due to the fact that dual-channel safety systems are, as a matter of fact, mechanically designed as single-channel systems at this point. If this mechanical linkage is extremely overdimensioned, the standard allows for fault exclusion for the fault conditions "Shaft breakage" and "Shaft slippage".

Hence, there are acceleration limit values for the individual drive solutions which must not be exceeded:

Synchronous servo motors	Encoder		Max. permissible angular acceleration	Min. time per 1000 r/min speed lift
	Type	Product key	[rad/s ²]	[ms]
MCS 06	Resolver	RS0	56000	1.9
MCS 09 ... 19			19000	5.5
MDXKS 56 / 71			17000	6.2

Asynchronous servo motors	Encoder		Max. permissible angular acceleration	Min. time per 1000 r/min speed lift
	Type	Product key	[rad/s ²]	[ms]
MCA 10 ... 19	Resolver	RS0	22000	4.8
MCA 20 ... 26			22000	4.8
MQA 20 ... 26			22000	4.8

Codes

Parameter:	Name:	Data type:	Index:
C15400	Motor encoder system	UNSIGNED_8	9175 _d = 23D7 _h
Selection of the encoder system connected			
Selection list (Lenze setting bold)		Information	
0	No encoder system		
1	Sin/cos encoder	"Sin/cos encoder" is used in place of the entries "Sin/cos encoder", "Absolute value encoder (Hiperface)" and "Absolute value encoder (EnDat)" of code C00422 of the standard device 9400.	
2	Resolver		
<input checked="" type="checkbox"/> Read access <input type="checkbox"/> Write access <input type="checkbox"/> Controller inhibit <input type="checkbox"/> PLC-STOP <input type="checkbox"/> No transfer			
C15401	Motor encoder status	UNSIGNED_8	9174 _d = 23D6 _h
Status of the encoder evaluation			
Selection list (read only)		Information	
0	Valid	Encoder data is valid	
1	Fault	Encoder data is invalid	
<input checked="" type="checkbox"/> Read access <input type="checkbox"/> Write access <input type="checkbox"/> Controller inhibit <input type="checkbox"/> PLC-STOP <input type="checkbox"/> No transfer			
C15402	Actual speed value n_safe	INTEGER_16	9173 _d = 23D5 _h
Display of the current speed calculated from the safety module			
Display area (min. value unit max. value)		Information	
-16000	rpm	16000	With invalid encoder data (C15401 = 1) 32767 is displayed.
<input checked="" type="checkbox"/> Read access <input type="checkbox"/> Write access <input type="checkbox"/> Controller inhibit <input type="checkbox"/> PLC-STOP <input type="checkbox"/> No transfer			
C15405	Internal actual speed value	INTEGER_16	9170 _d = 23D2 _h
Internal actual speed values of SM301.			
Display area (min. value unit max. value)		Information	
-16000	rpm	16000	(As of SM301 V1.4) With invalid encoder data (C15401 = 1) 32767 is displayed.
Subcodes		Information	
C15405/1	-	Internal actual speed value nSM detected from motor position.	
C15405/2	-	Internal actual speed value nGG detected from position data of the standard device.	
<input checked="" type="checkbox"/> Read access <input type="checkbox"/> Write access <input type="checkbox"/> Controller inhibit <input type="checkbox"/> PLC-STOP <input type="checkbox"/> No transfer			
C15409	Motor mounting direction	UNSIGNED_8	9166 _d = 23CE _h
Setting of the motor mounting direction.			
Selection list (Lenze setting bold)		Information	
0	Motor rotating clockwise	(From SM301 V1.4)	
1	Motor rotating counter-clockwise		
<input checked="" type="checkbox"/> Read access <input type="checkbox"/> Write access <input type="checkbox"/> Controller inhibit <input type="checkbox"/> PLC-STOP <input type="checkbox"/> No transfer			
C15410	Response time of encoder monitoring	UNSIGNED_8	9165 _d = 23CD _h
Max. internal time after which encoder errors lead to a system response			
Selection list		Information	
0	12 ms	(As of SM301 V1.2)	
10	50 ms	(From SM301 V1.4: Resolver is sole encoder → 50 or 100 ms)	
20	100 ms		
<input checked="" type="checkbox"/> Read access <input type="checkbox"/> Write access <input type="checkbox"/> Controller inhibit <input type="checkbox"/> PLC-STOP <input type="checkbox"/> No transfer			

Safe speed measurement and position detection

Parameter:	Name:	Data type:	Index:
C15411	Tolerance of speed comparison	UNSIGNED_16	9164 _d = 23CC _h
Tolerance of the speed comparison in the safety module			
Display area (min. value unit max. value)		Information	
0	rpm	16000	(From SM301 V1.3)
<input checked="" type="checkbox"/> Read access <input type="checkbox"/> Write access <input type="checkbox"/> Controller inhibit <input type="checkbox"/> PLC-STOP <input type="checkbox"/> No transfer			
C15420	Number of increments - sin/cos encoder	UNSIGNED_16	9155 _d = 23C3 _h
Number of increments of the sin/cos encoder used			
Setting range (min. value unit max. value)		Information	
1		16384	Lenze: 1
<input checked="" type="checkbox"/> Read access <input type="checkbox"/> Write access <input type="checkbox"/> Controller inhibit <input type="checkbox"/> PLC-STOP <input type="checkbox"/> No transfer			
C15430	Number of pole pairs of resolver	UNSIGNED_8	9145 _d = 23B9 _h
Number of pole pairs of the used resolver			
Setting range (min. value unit max. value)		Information	
1		10	Lenze: 1 (From SM301 V1.3)
<input checked="" type="checkbox"/> Read access <input type="checkbox"/> Write access <input type="checkbox"/> Controller inhibit <input type="checkbox"/> PLC-STOP <input type="checkbox"/> No transfer			
C15500	Position encoder system	UNSIGNED_8	9075 _d = 2373 _h
Setting of the connected position encoder system			
Selection list (read only)		Information	
0	No position encoder	(From SM301 V1.3)	
1	Analog encoder (Sin-Cos/TTL)		
2	Digital encoder (SSI/BUS)		
<input checked="" type="checkbox"/> Read access <input type="checkbox"/> Write access <input type="checkbox"/> Controller inhibit <input type="checkbox"/> PLC-STOP <input type="checkbox"/> No transfer			
C15501	Position encoder - gearbox factor	UNSIGNED_16	9074 _d = 2372 _h
Setting of the gearbox factor between motor and position encoder			
Display area (min. value unit max. value)		Information	
20	%	50000	Lenze: 100 (From SM301 V1.3) 100 ≙ i = 1.00 2543 ≙ i = 25.43
<input checked="" type="checkbox"/> Read access <input type="checkbox"/> Write access <input type="checkbox"/> Controller inhibit <input type="checkbox"/> PLC-STOP <input type="checkbox"/> No transfer			
C15502	Position encoder - mounting direction	UNSIGNED_8	9073 _d = 2371 _h
Setting of the mounting direction of the position encoder regarding the motor encoder			
Selection list (read only)		Information	
0	Like motor encoder	(From SM301 V1.3) If the mounting directions of the motor (C02527/0) and position encoder (C02529/0) in the standard device are set in different directions of rotation, this parameter must be set to "inverted to the motor encoder".	
1	Inverted to the motor encoder		
<input checked="" type="checkbox"/> Read access <input type="checkbox"/> Write access <input type="checkbox"/> Controller inhibit <input type="checkbox"/> PLC-STOP <input type="checkbox"/> No transfer			

1 Safety engineering

Safety functions
General information

1.3 Safety functions

1.3.1 General information

1.3.1.1 Stop functions

The stop functions are distinguished according to the cause of release:

- ▶ Standard stop (simple stop)
 - Release by a safe input with the parameterised STO, SS1 or SS2 functions
 - Release by activating the bits STO, SS1 or SS2 bits via the safety bus.
 - In special operation the standard stop can be avoided by using the enable switch.
- ▶ Emergency stop
 - Release by a safe input with the parameterised "Safe stop emergency" (SSE) function.
 - Release by activating the SSE bit via the safety bus.
 - STO or SS1 can be set as emergency stop function to be executed.
 - In special operation, the emergency stop **cannot** be avoided.
- ▶ Error stop
 - Release as response to an error.
 - In special operation, the error stop **cannot** be avoided.

Codes

Parameter:	Name:	Data type:	Index:
C15205	SSE: Safe stop emergency function	UNSIGNED_8	9370 _d = 249A _h

Selection of the stop function for emergency stop

Selection list (Lenze setting printed in bold)	Information
0 STO	Safe torque off
1 SS1	Safe stop 1

Read access Write access Controller inhibit PLC-STOP No transfer

1.3.1.2 Prioritisation

Stop functions with priority influence the sequence of subordinated functions already started.

- ▶ STO
The STO function has the highest priority over all other functions. Functions already started (e.g. SS1 or SS2) are aborted and the drive is switched off.
- ▶ SS1
The SS1 function has priority over SS2. Considering the set stopping time for SS1 and SS2 (C15305) and the SS1 mode (C15306 as of SM301 V1.3), the drive is switched to torque-free operation.
- ▶ Monitoring functions
The monitoring functions have equivalent priorities. They can be executed at the same time.

Codes

Parameter:	Name:	Data type:	Index:
C15305	SS1, SS2: Stopping time	UNSIGNED_16	9270 _d = 2436 _h
Stopping time for the SS1 and SS2 safety functions			
Setting range (min. value unit max. value)		Information	
0	MS	30000	Lenze: 0, increment: 2 ms
<input checked="" type="checkbox"/> Read access <input type="checkbox"/> Write access <input type="checkbox"/> Controller inhibit <input type="checkbox"/> PLC-STOP <input type="checkbox"/> No transfer			
C15306	SS1 mode	UNSIGNED_8	9269 _d = 2435 _h
Selection list (Lenze setting bold)		Information	
0	STO after stopping time	(From SM301 V1.3)	
1	STO at n = 0		
<input checked="" type="checkbox"/> Read access <input type="checkbox"/> Write access <input type="checkbox"/> Controller inhibit <input type="checkbox"/> PLC-STOP <input type="checkbox"/> No transfer			

1.3.1.3 Restart

The restart behaviour of the drive can be parameterised (C15300).

- ▶ The "acknowledged restart" setting requires an acknowledgement to the safety module. The acknowledgement is made via:
 - Signal at the AIS input (with a signal time of 0.3 ... 10 s)
 - Signal via the "PS_AIS" time (PROFIsafe)
- ▶ An error stop requires an acknowledgement (AIE), before the restart can be acknowledged.
- ▶ The "Automatic restart" setting requires an acknowledgement at the master control.
- ▶ With active cascading (C15035 as of SM301 V1.1) an "Automatic restart" after STO, SS1 is not possible.



Danger!

When the request for the safety function is deactivated, the drive can restart automatically. The behaviour can be set via the parameter "Restart behaviour" (C15300/1/2).

In the case of an automatic restart, you must provide external measures which ensure that the drive only restarts after an acknowledgement (EN 60204).

Codes

Parameter:	Name:	Data type:	Index:
C15300	Restart behaviour	UNSIGNED_8	9275 _d = 243B _h
Behaviour for restart after functions have been cancelled			
Selection list (Lenze setting bold)		Information	
0	Acknowledged restart		
1	Automatic restart		
Subcodes		Information	
C15300/1		Restart - STO, SS1	
C15300/2		Restart - SS2, SOS	
<input checked="" type="checkbox"/> Read access <input type="checkbox"/> Write access <input type="checkbox"/> Controller inhibit <input type="checkbox"/> PLC-STOP <input type="checkbox"/> No transfer			

1.3.2 Integration into the application of the controller

For the use of the functions, certain settings in the controller are required. Here, the Lenze PC software »Engineer« supports and guides you.

When a safety function is required, the safety technology activates the corresponding safe monitoring function. However, the standstill function is only directly executed with the "safe torque off" (STO) function. Other safety functions in which a controller action is required will need to be safely monitored.

The action of the drive (e.g. braking, braking to standstill, keeping the standstill position) must be implemented by the user application in the standard device.

Currently the application can be parameterised and/or configured via function block editor of the Engineer depending on the runtime software licence. For this, the system block **LS_SafetyModuleInterface** must be integrated into the application.

The safety module is implemented in the 9400 ServoPLC via the control configuration (SMI_SafetyModuleInterface). The control and status data of the safety module can be evaluated via the free programming and connected to further interface signals.

The connection to a user application serves to achieve the following:

1. Activation of the safety function in the safety module, e.g. SS1.
→ The monitoring starts.
2. The safety module transmits the information to the basic device that the function has been activated using the corresponding bit in the control word *SMI_dwControl*.
3. The application evaluates the control word and starts the motion sequence, e.g. braking etc.

Internal communication

Safety module and standard device communicate via an internal interface.

1 Safety engineering

Safety functions

Integration into the application of the controller

1.3.2.1 Control information

The safety module transfers information via requested or active safety functions with the control word `SMI_dwControl`. The application in the standard device must evaluate the control word and execute the corresponding action.

The following table shows the bit coding of the control word.

Control word - <code>SMI_dwControl</code>		
Bit	Name	Meaning
1	SS1 active	Safe stop 1 requested
2	SS2 active	Safe stop 2 requested
3	SLS1 active	Safely limited speed 1 requested
4	SLS2 active	Safely limited speed 2 requested (as of SM301 V1.1)
5	SLS3 active	Safely limited speed 3 requested (as of SM301 V1.1)
6	SLS4 active	Safely limited speed 4 requested (as of SM301 V1.1)
7	SDIpos is active	The safe positive direction of movement (SDIpos) function is active. (As of SM301 V1.3) After the parameterised SDI deceleration time has expired, bit 12 of the status signal <code>SMI_dnState</code> (<i>Sdlpos monitored</i>) is set in addition.
8	SDIneg is active	The safe negative direction of movement (SDIneg) function is active. (As of SM301 V1.3) After the parameterised SDI deceleration time has expired, bit 13 of the status signal <code>SMI_dnState</code> (<i>Sdlneg monitored</i>) is set in addition.
9	ES active	Motion functions in special operation requested
10	SLI is active	Safely limited increment is active.(As of SM301 V1.4)
11	OMS	Special operation requested (0 = normal operation)
16	SOS is active	Safe operating stop maintained
17	SLS1 monitored	Safely limited speed 1 maintained
18	SLS2 monitored	Safely limited speed 2 maintained (as of SM301 V1.1)
19	SLS3 monitored	Safely limited speed 3 maintained (as of SM301 V1.1)
20	SLS4 monitored	Safely limited speed 4 maintained (as of SM301 V1.1)
23	SSE active	Emergency stop active (Safe Stop Emergency)
29	OMS active	Special operation active (Operation Mode Selector) (as of SM301 V1.1)
31	Error	Error detected (0 = proper operation)

1.3.2.2 Status information

The safety module transfers information via the status of safety functions with the `SMI_dnState` status word.

The `SMI_dnIoState` status word contains information on the status of the safe inputs and the safe output. The application in the standard device can evaluate and use the status words for additional tasks.

The following tables show the bit coding of the status words:

Status word SMI_dnState

Bit	Name	Meaning
0	STO	Safe torque off is active.
3	EC_STO	Error stop category 0 is active (Safe Torque Off).
4	EC_SS1	Error stop category 1 is active (Safe Stop 1).
5	EC_SS2	Error stop category 2 is active (Safe Stop 2).
8	SLS1 monitored	Safely limited speed 1 is activated and maintained.
9	SLS2 monitored	Safely limited speed 2 is activated and maintained. (from SM301 V1.1)
10	SLS3 monitored	Safely limited speed 3 is activated and maintained. (from SM301 V1.1)
11	SLS4 monitored	Safely limited speed 4 is activated and maintained. (from SM301 V1.1)
12	SDIpos monitored	Safe positive direction (SDIpos) is activated and maintained. (from SM301 V1.3)
13	SDIneg monitored	Safe negative direction (SDIneg) is activated and maintained. (from SM301 V1.3)
14	Error active	SM301 safety module in error status (trouble or warning).

Unlisted bits are reserved for future extensions!

Status word SMI_dniOState

Bit	Name	Meaning
0	SD-In1	Sensor input 1 in ON state.
1	SD-In2	Sensor input 2 in ON state.
2	SD-In3	Sensor input 3 in ON state.
3	SD-In4	Sensor input 4 in ON state.
5	AIS	Restart acknowledgement via terminal in ON state.
6	AIE	Error acknowledgement via terminal ON state.
8	PS_AIS	Restart acknowledgement via safety bus.
9	PS_AIE	Error acknowledgement via safety bus.
12	SD-Out1	Safe output 1 (feedback output) in ON state.

Unlisted bits are reserved for future extensions!

If communication to the standard device is interrupted, e.g. by switching off the standard device, the safety module responds by means of the following actions:

- ▶ Error stop with STO is activated
- ▶ "Warning" error message is transmitted
- ▶ The "ME" LED is blinking

The required fault acknowledgement (AIE) is possible via terminal or safety bus. For further information read the "Error management" chapter.

1 Safety engineering

Safety functions

Safe torque off

1.3.3 Safe torque off

1.3.3.1 Description

Safe Torque Off/STO

This function corresponds to a "Stop 0" according to EN 60204.

When this function is used, the power supply of the motor is immediately (t_1) safely interrupted. The motor cannot create a torque and thus no dangerous movements of the drive can occur. Additional measures, e.g. mechanical brakes are needed against movements caused by external force.

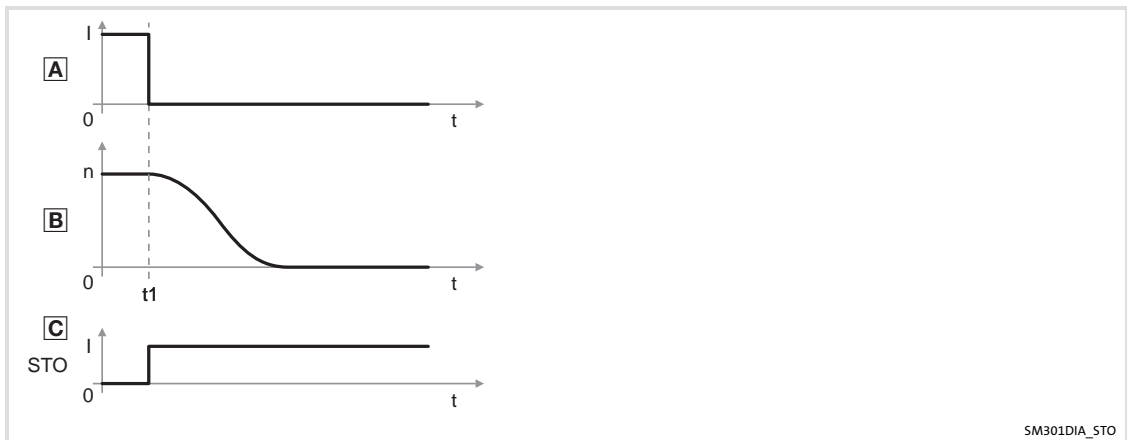

SM301DIA_STO

- A** Input signal of the request of a safety function
 - I ON state
 - O OFF state
- B** Speed characteristic n of the motor
 - t Time axis
 - t_x Action instant
- C** Feedback(s)

The restart behaviour can be set (C15300/1). Function sequence and error response have no adjustable parameters.

Codes

Parameter:	Name:	Data type:	Index:
C15300	Restart behaviour	UNSIGNED_8	9275 _d = 243B _h
Behaviour for restart after functions have been cancelled			
Selection list (Lenze setting bold)		Information	
0	Acknowledged restart		
1	Automatic restart		
Subcodes		Information	
C15300/1			Restart - STO, SS1
C15300/2			Restart - SS2, SOS
<input checked="" type="checkbox"/> Read access <input checked="" type="checkbox"/> Write access <input type="checkbox"/> Controller inhibit <input type="checkbox"/> PLC-STOP <input type="checkbox"/> No transfer			

1.3.3.2 Activation

How to activate the function:

- ▶ "OFF state" at a safe input, the function of which has been assigned by parameter setting.
- ▶ Via a safety bus data telegram with corresponding content.
- ▶ As response to the error stop request.
- ▶ As response to the emergency stop request if the function has been parameterised as emergency stop function (C15205).

1 Safety engineering

Safety functions

Safe stop 1

1.3.4 Safe stop 1

1.3.4.1 Description

Safe Stop 1 / SS1

This function corresponds to a "Stop 1" according to EN 60204.

The function monitors the reaching of the speed $n = 0$ (C15310) within an adjustable stopping time (C15305). The speed is calculated from the encoder data (safe speed measurement). Without encoder the function evaluates the speed status $n = 0$ from the standard device. For this, the monitored stopping time parameterised in the safety module must be 0.5 s longer than the stopping time in the controller.

When the stopping time (t_2) has expired, the motor power supply is safely interrupted (STO) immediately. The motor cannot create a torque and thus no dangerous movements of the drive. If standstill has not been achieved, an additional error message is triggered. Depending on the SS1 mode (C15306), the drive can also be switched off safely (STO) directly after the zero speed has been reached. This causes reduced cycle times. C15307 can be used to parameterise an additional deceleration time, e.g. for the application of a holding brake.

Additional measures, e.g. mechanical brakes are needed against movements caused by external force. The time for a brake to be applied must be considered when defining the stopping time.

A restart is only possible after the stopping time has expired completely (is valid up to SM301 V1.2 and from SM301 V1.3 if C15306 SS1 mode = "STO after stopping time"). If the parameter SS1 mode = "STO at $n=0$ " (from SM301 V1.3), the restart can be executed after the transition to the STO state.

From SM301 V1.4 onwards, deceleration ramp monitoring can be parameterised. Depending on the parameterised stopping time, a monitoring ramp is calculated. (📖 64)

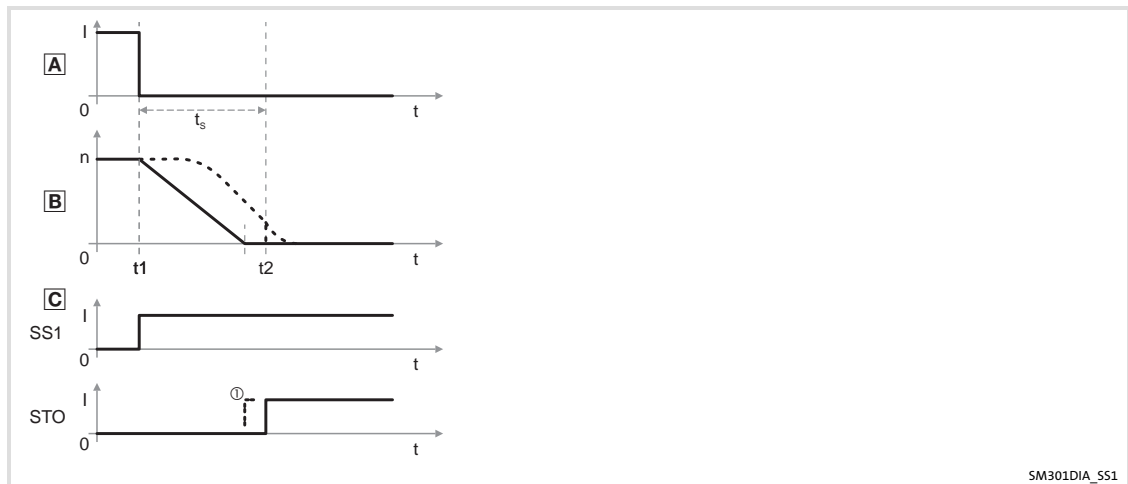

SM301DIA_SS1

- A** Input signal of the request of a safety function
 - I ON state
 - 0 OFF state
- B** Speed characteristic n of the motor
 - Optional: Monitoring of the brake ramp as of SM301 V1.4
- t Time axis
- t_x Action instant
- t_s Monitored stopping time
- Normal operation
- Incorrect operation
- C** Feedback(s)
- ① SS1 mode (C15306) influences the switching time and contains the "SS1:Deceleration STO after $n=0$ " (C15307)

Codes

Parameter:	Name:	Data type:	Index:
C15300	Restart behaviour	UNSIGNED_8	9275 _d = 243B _h
Behaviour for restart after functions have been cancelled			
Selection list (Lenze setting bold)		Information	
0	Acknowledged restart		
1	Automatic restart		
Subcodes		Information	
C15300/1		Restart - STO, SS1	
C15300/2		Restart - SS2, SOS	
<input checked="" type="checkbox"/> Read access <input type="checkbox"/> Write access <input type="checkbox"/> Controller inhibit <input type="checkbox"/> PLC-STOP <input type="checkbox"/> No transfer			
C15305	SS1, SS2: Stopping time	UNSIGNED_16	9270 _d = 2436 _h
Stopping time for the SS1 and SS2 safety functions			
Setting range (min. value unit max. value)		Information	
0	MS	30000	Lenze: 0, increment: 2 ms
<input checked="" type="checkbox"/> Read access <input type="checkbox"/> Write access <input type="checkbox"/> Controller inhibit <input type="checkbox"/> PLC-STOP <input type="checkbox"/> No transfer			
C15306	SS1 mode	UNSIGNED_8	9269 _d = 2435 _h
Selection list (Lenze setting bold)		Information	
0	STO after stopping time	(From SM301 V1.3)	
1	STO at n = 0		
<input checked="" type="checkbox"/> Read access <input type="checkbox"/> Write access <input type="checkbox"/> Controller inhibit <input type="checkbox"/> PLC-STOP <input type="checkbox"/> No transfer			
C15307	SS1: Deceleration STO after n=0	UNSIGNED_16	9268 _d = 2434 _h
Display area (min. value unit max. value)		Information	
0	ms	30000	Lenze: 0, increment: 2 ms (From SM301 V1.3)
<input checked="" type="checkbox"/> Read access <input type="checkbox"/> Write access <input type="checkbox"/> Controller inhibit <input type="checkbox"/> PLC-STOP <input type="checkbox"/> No transfer			
C15310	Tolerance window (n=0)	INTEGER_16	9265 _d = 2431 _h
Safely monitored tolerance window for zero speed			
Setting range (min. value unit max. value)		Information	
0	rpm	16000	Lenze: 0
<input checked="" type="checkbox"/> Read access <input type="checkbox"/> Write access <input type="checkbox"/> Controller inhibit <input type="checkbox"/> PLC-STOP <input type="checkbox"/> No transfer			

1.3.4.2 Activation

How to activate the function:

- ▶ "OFF state" at a safe input, the function of which has been assigned by parameter setting.
- ▶ Via a safety bus data telegram with corresponding content.
- ▶ As response to the error stop request.
- ▶ As response to the emergency stop request if the function has been parameterised as emergency stop function (C15205).



Note!

During the safe cascading of a drive system, the SS1 mode (C15306) (from V1.3) must be parameterised to "STO after stopping time". The first one of the drives which is at standstill changes to the STO status, thereby triggering STO for the entire drive system. Those drives which are not at standstill yet are coasting in an uncontrolled way. Therefore, a fixed stopping time for all drives makes sense here.

1 Safety engineering

Safety functions

Safe stop 2

1.3.5 Safe stop 2

1.3.5.1 Description

Safe Stop 2 / SS2

This function corresponds to a "Stop 2" according to EN 60204.

This function serves to monitor the reaching of speed $n = 0$ within an adjustable stopping time (C15305). The reached position must be kept active by the controller. The function SS2 changes to the safe operational stop (SOS) after the stopping time has expired. This function is implemented in the SM301 up to version 1.2 as a monitoring function of a speed band. Thus, the SOS function and accordingly the SS2 function is implemented deviating from the EN 61800-5-2 standard which demands the monitoring of a position windows in section 4.2.3.1. As of version 1.3, the function is implemented in compliance with the standard, i.e. the monitoring is executed through a parameterisable position window (C15311). Depending on the SS2 mode (C15308) the drive can also be switched directly to the safe operational stop (SOS) after zero speed has been reached. This causes reduced cycle times.

For speed $n = 0$, a tolerance window (C15310) can be parameterised. For the tolerance window $\Delta p=0$ (C15311), a relative position is defined by which the drive may move in the SOS state.

From SM301 V1.3 onwards, the tolerance window for standstill detection (C15310) is used to control the transition to the SOS state subject to the "SS2 mode" parameter (C15308). C15308 serves to determine whether the SOS state is reached after the stopping time has expired or after the reaching of $n = 0$. In the SOS state, the standstill monitoring based on the position takes place. The respective limit value is set via the parameter "SOS: Tolerance window ($\Delta p=0$)" C15311.

The speed and the position are calculated from the encoder data (safe speed measurement). Without an encoder, the function cannot be used.

If the monitored limits are exceeded, an error stop will be caused. The power supply of the motor is immediately safely interrupted (STO). The motor cannot create a torque and thus no dangerous movements of the drive can occur. Additional measures, e.g. mechanical brakes are needed against movements caused by external force.

A restart is only possible after the stopping time has expired completely (up to V1.2 and V1.3 with C15308 "SS2-mode = SOS after stopping time").

If the parameter SS2 mode = "SOS at $n=0$ " (from V1.3), the restart can be executed after the transition to the SOS state.

This does not apply to special operations.

From SM301 V1.3 onwards, the higher-prior stop function SS1/STO is executed when the SS2 stop request and SS1/STO occur at the same time. After the SS1/STO request has been cancelled and acknowledged accordingly (see restart behaviour), a direct STO transition to the SS2/STO state can be achieved without cancelling the SS2 request. Up to SM301 V1.2, the cancellation of all stop functions incl. SS2 before an acknowledgement was necessary in order to reach the SOS state via an SS2 request.

From SM301 V1.4 onwards, deceleration ramp monitoring can be parameterised. Depending on the parameterised stopping time, a monitoring ramp is calculated. (📖 64)

**Note!**

The position of the motor is saved when the SOS state is entered. In the SOS state, relative position changes are added and compared to the permissible value in the parameter "Tolerance window Delta p=0". When the SOS state is quit, the maximum relative position change is displayed in code C15312. When the SOS state is requested again, the maximum value of the last position changes is reset to zero.

Example: The states "SS2 active" and "SOS active" are interrupted by a STO request. When the STO request is reset, an immediate transition to the SOS state takes place. This causes a reset of the current position deviation to p=0. After the safe operational stop is interrupted by the STO, the motor may have a different position due to an external torque.

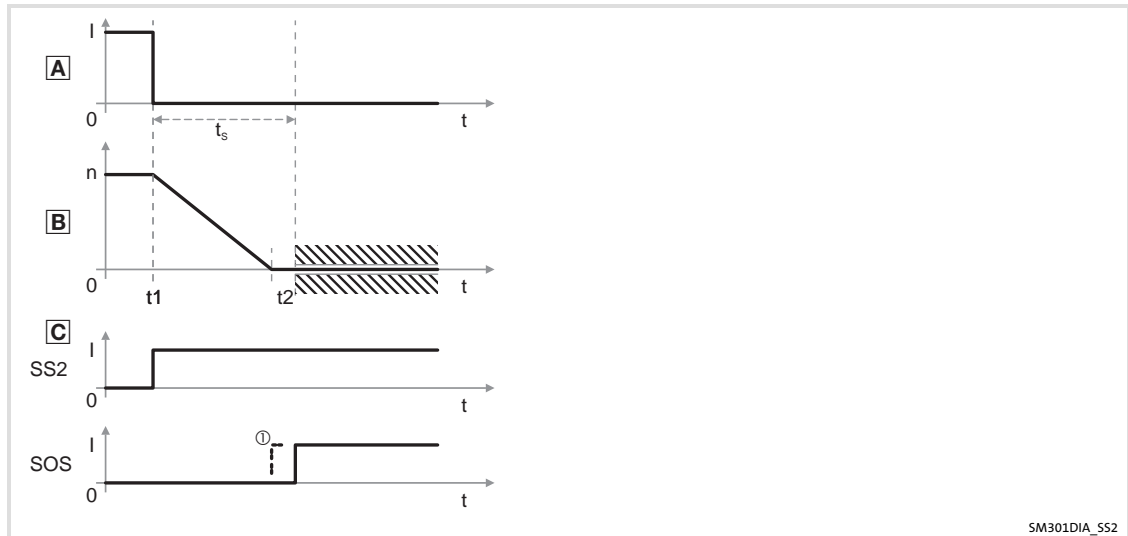

- Ⓐ Input signal of the request of a safety function
 - I ON state
 - 0 OFF state
- Ⓑ Speed characteristic n of the motor
 - Speed-monitored up to SM301 V1.2
 - Position-monitored as of SM301 V1.3
 - Optional: Monitoring of the brake ramp as of SM301 V1.4
- t Time axis
- t_x Action instant
- t_s Monitored stopping time
- Ⓒ Feedback(s)
- ① SS2 mode (C15308) influences the switching time



Tip!

Adapt the deceleration time for quick stop (C00105) of the standard device to the stopping time SS1, SS2 (C15305).

The drive must have reached standstill before the stopping time has elapsed.

Codes

Parameter:	Name:	Data type:	Index:
C15300	Restart behaviour	UNSIGNED_8	9275 _d = 243B _h
Behaviour for restart after functions have been cancelled			
Selection list (Lenze setting bold)		Information	
0	Acknowledged restart		
1	Automatic restart		
Subcodes		Information	
C15300/1		Restart - STO, SS1	
C15300/2		Restart - SS2, SOS	
<input checked="" type="checkbox"/> Read access <input type="checkbox"/> Write access <input type="checkbox"/> Controller inhibit <input type="checkbox"/> PLC-STOP <input type="checkbox"/> No transfer			
C15305	SS1, SS2: Stopping time	UNSIGNED_16	9270 _d = 2436 _h
Stopping time for the SS1 and SS2 safety functions			
Setting range (min. value unit max. value)		Information	
0	MS	30000	Lenze: 0, increment: 2 ms
<input checked="" type="checkbox"/> Read access <input type="checkbox"/> Write access <input type="checkbox"/> Controller inhibit <input type="checkbox"/> PLC-STOP <input type="checkbox"/> No transfer			
C15308	SS2 mode	UNSIGNED_8	9267 _d = 2433 _h
Selection whether SS2 is to be executed already after reaching n=0 SOS or only after reaching the parameterised stopping time.			
Selection list (Lenze setting bold)		Information	
0	SOS after stopping time	(As of SM301 V1.3)	
1	SOS at n = 0		
<input checked="" type="checkbox"/> Read access <input type="checkbox"/> Write access <input type="checkbox"/> Controller inhibit <input type="checkbox"/> PLC-STOP <input type="checkbox"/> No transfer			
C15310	Tolerance window (n=0)	INTEGER_16	9265 _d = 2431 _h
Safely monitored tolerance window for zero speed			
Setting range (min. value unit max. value)		Information	
0	rpm	16000	Lenze: 0
<input checked="" type="checkbox"/> Read access <input type="checkbox"/> Write access <input type="checkbox"/> Controller inhibit <input type="checkbox"/> PLC-STOP <input type="checkbox"/> No transfer			
C15311	SOS: Tolerance window (Delta p=0)	UNSIGNED_32	9264 _d = 2430 _h
Safely monitored tolerance window for zero position change			
Display area (min. value unit max. value)		Information	
0	Incr.	327680	Lenze: 0 (From SM301 V1.3)
<input checked="" type="checkbox"/> Read access <input type="checkbox"/> Write access <input type="checkbox"/> Controller inhibit <input type="checkbox"/> PLC-STOP <input type="checkbox"/> No transfer			
C15312	SOS: Maximum change in position	UNSIGNED_32	9263 _d = 242F _h
Amount of the maximum change in position while SOS was active			
Display area (min. value unit max. value)		Information	
0	Incr.	2147483647	(From SM301 V1.3)
<input checked="" type="checkbox"/> Read access <input type="checkbox"/> Write access <input type="checkbox"/> Controller inhibit <input type="checkbox"/> PLC-STOP <input type="checkbox"/> No transfer			

1.3.5.2

Activation

How to activate the function:

- ▶ "OFF state" at a safe input, the function of which has been assigned by parameter setting.
- ▶ Via a safety bus data telegram with corresponding content.
- ▶ As response to the error stop request.

1.3.6 **Ramp monitoring SS1/SS2**

1.3.6.1 **Description**

From SM301 V1.4 onwards, the deceleration ramp for the stop functions SS1 and SS2 can be parameterised and monitored. If the parameterised ramp is not exceeded, the state changes to the parameterised stop function STO or SOS.

The monitoring of the deceleration process serves to achieve a higher degree of safety. Ramp monitoring becomes most critical when delay times are caused by high moments of inertia

- ▶ Braking the drive to standstill and holding the position must still be executed by the application!
- ▶ A safe speed evaluation is the precondition for a safe ramp monitoring, i.e. an encoder system must be parameterised in the safety module.
- ▶ When ramp monitoring is activated, the starting value of the ramp and the S-ramp time must be defined in percent.
 - The starting value refers to the current speed value at the time of the SS1/SS2 request.
 - The starting time of the deceleration ramp is delayed via the S-ramp time in order to consider a possible S-ramp smoothing.

If the current speed exceeds the parameterised deceleration ramp within the stopping time or before reaching the tolerance window ($n=0$), an error message is caused and an error stop is initiated.

- ▶ The power supply of the motor is immediately safely interrupted (STO). The motor cannot create a torque and thus no dangerous movements of the drive can occur.

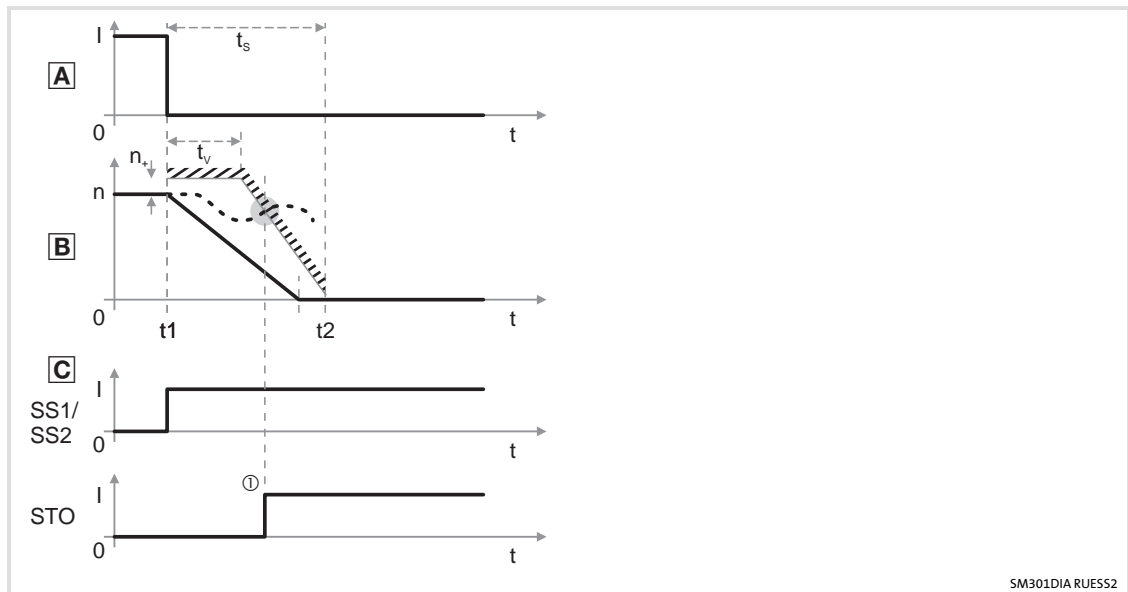

- A** Input signal of the request of a safety function
 - I ON state
 - 0 OFF state
- B** Speed characteristic n of the motor
 - Speed-monitored up to SM301 V1.2
 - Position-monitored as of SM301 V1.3
 - Optional: Monitoring of the brake ramp as of SM301 V1.4
- n_+ Start offset ramp
- t Time axis
- t_x Action instant
- t_S Monitored stopping time
- t_V S-ramp time
- Normal operation
- Incorrect operation
- C** Feedback(s)
- ① If the speed exceeds the parameterised brake ramp, an error message is triggered and an error stop is initiated.

Codes

C15305	SS1, SS2: Stopping time	UNSIGNED_16	9270 _d = 2436 _h
Stopping time for the SS1 and SS2 safety functions			
Setting range (min. value unit max. value)		Information	
0	MS	30000	Lenze: 0, increment: 2 ms
<input checked="" type="checkbox"/> Read access <input type="checkbox"/> Write access <input type="checkbox"/> Controller inhibit <input type="checkbox"/> PLC-STOP <input type="checkbox"/> No transfer			
C15310	Tolerance window (n=0)	INTEGER_16	9265 _d = 2431 _h
Safely monitored tolerance window for zero speed			
Setting range (min. value unit max. value)		Information	
0	rpm	16000	Lenze: 0
<input checked="" type="checkbox"/> Read access <input type="checkbox"/> Write access <input type="checkbox"/> Controller inhibit <input type="checkbox"/> PLC-STOP <input type="checkbox"/> No transfer			
C15315	SS1, SS2: ramp monitoring	UNSIGNED_8	9260 _d = 242C _h
Selection whether the brake ramp is to be monitored when SS1 and SS2 are executed.			
Selection list (Lenze setting bold)		Information	
0	No ramp monitoring	(From SM301 V1.4)	
1	Ramp monitoring is activated		
<input checked="" type="checkbox"/> Read access <input type="checkbox"/> Write access <input type="checkbox"/> Controller inhibit <input type="checkbox"/> PLC-STOP <input type="checkbox"/> No transfer			

C15316	SS1, SS2: S-ramp time	UNSIGNED_8	9259 _d = 242B _h
S-ramp time of deceleration ramp for SS1 and SS2 if a linear ramp is not used.			
Setting range (min. value unit max. value)		Information	
0	%	100	0 (From SM301 V1.4)
<input checked="" type="checkbox"/> Read access <input type="checkbox"/> Write access <input type="checkbox"/> Controller inhibit <input type="checkbox"/> PLC-STOP <input type="checkbox"/> No transfer			
C15317	SS1, SS2: Start offset ramp	UNSIGNED_8	9258 _d = 242A _h
Speed offset at the start of the ramp monitoring.			
Display area (min. value unit max. value)		Information	
0	%	30	0 (From SM301 V1.4)
<input checked="" type="checkbox"/> Read access <input type="checkbox"/> Write access <input type="checkbox"/> Controller inhibit <input type="checkbox"/> PLC-STOP <input type="checkbox"/> No transfer			

1.3.6.2

Activation

How to activate the function:

- ▶ The ramp monitoring must be activated via the C15315 parameter.
- ▶ When the stop functions SS1/SS2 are requested, a monitoring ramp is calculated and applied to the current speed characteristic.

**Note!**

- ▶ The parameterisation of the monitoring ramp in the safety module must consider the parameters of the deceleration ramp from within the application.
- ▶ Based on the actual speed, a parameterisable percentage (0 ... 30 %) is added to the actual speed as a start offset and used as a constant starting value.
 - In the Lenze setting of the start offset (C15317), the tolerance window (n = 0) is considered as an offset.
- ▶ The monitoring ramp only starts after an internal deceleration time has expired which has been generated as a function of the parameters "SS1, SS2: S-ramp time" and "SS1, SS2: Stopping time":
 - The parameter "SS1, SS2: S-ramp time" is scaled linearly from 10 ... 30 % of the stopping time:
 - 0 % S-ramp time ≡ 10 % deceleration
 - 100 % S-ramp time ≡ 30 % deceleration
 - In the Lenze setting of the S-ramp time, the deceleration time is 10 % of the set stopping time.

1.3.7 Emergency stop

1.3.7.1 Description

Safe Stop Emergency/SSE

The emergency stop function activates STO or SS1. The function to be executed can be set (C15205). There is no way to avoid emergency stopping during special operation.

With active cascading (C15035 from SM301 V1.1) only "STO" is permissible as emergency stop.



Note!

Connect the emergency stop buttons which must not be overruled by a special operation to the emergency stop function. For this purpose, parameterise the safe input as "emergency stop" (C15031).

The emergency stop function can also be requested with SSE bit via the safety bus.

The activation of the function is reported internally to the standard device and via the safety bus of the higher-level control.

Codes

Parameter:	Name:	Data type:	Index:
C15205	SSE: Safe stop emergency function	UNSIGNED_8	9370 _d = 249A _h
Selection of the stop function for emergency stop			
Selection list (Lenze setting printed in bold)		Information	
0	STO	Safe torque off	
1	SS1	Safe stop 1	
<input checked="" type="checkbox"/> Read access <input checked="" type="checkbox"/> Write access <input type="checkbox"/> Controller inhibit <input type="checkbox"/> PLC-STOP <input type="checkbox"/> No transfer			

1.3.7.2 Activation

How to activate the function:

- ▶ "OFF state" at a safe input, the function of which has been assigned by parameter setting.
- ▶ Via a safety bus data telegram with corresponding content.

1 Safety engineering

Safety functions

Safe maximum speed

1.3.8 Safe maximum speed

1.3.8.1 Description

Safe Maximum Speed / SMS

This function monitors the maximum motor speed. If a value > 0 is indicated (C15320), the function is activated.

If the maximum speed is exceeded, a error stop is caused. STO, SS1 or SS2 (C15321) can be adjusted.

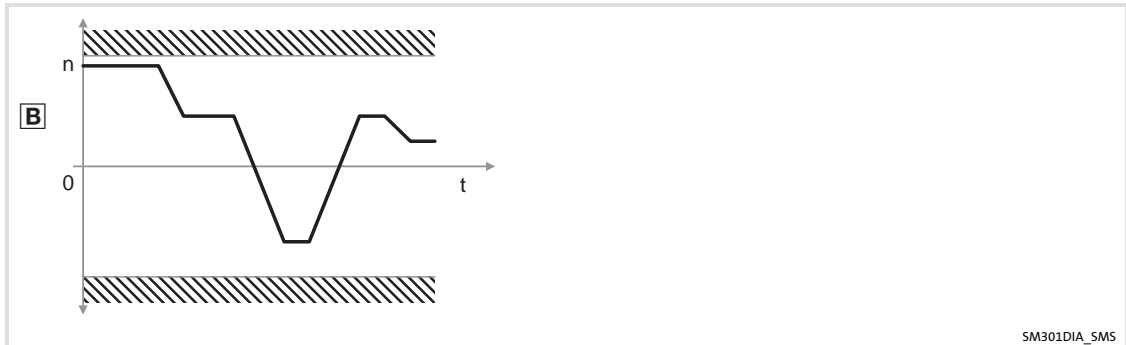

B Speed characteristic n of the motor
t Time axis

Codes

Parameter:	Name:	Data type:	Index:
C15320	SMS: Max. speed Nmax	INTEGER_16	9255 _d = 2427 _h

Selection of the maximum speed and activation of the SMS function

Setting range (min. value unit max. value)	Information
0 rpm 16000	Lenze: 1, deactivate: 0
<input checked="" type="checkbox"/> Read access <input checked="" type="checkbox"/> Write access <input type="checkbox"/> Controller inhibit <input type="checkbox"/> PLC-STOP <input type="checkbox"/> No transfer	

Parameter:	Name:	Data type:	Index:
C15321	SMS: Response (n>Nmax)	UNSIGNED_8	9254 _d = 2426 _h

Response to the exceeding of the set maximum speed

Selection list (Lenze setting bold)	Information
0 STO	Safe torque off
1 SS1	Safe stop 1
2 SS2	Safe stop 2
<input checked="" type="checkbox"/> Read access <input checked="" type="checkbox"/> Write access <input type="checkbox"/> Controller inhibit <input type="checkbox"/> PLC-STOP <input type="checkbox"/> No transfer	

Parameter:	Name:	Data type:	Index:
C15350	SLS, SMS: Max. response time	UNSIGNED_16	9225 _d = 2409 _h

Maximum time after an exceeded speed has been detected, after which the speed must be below the limit again.

Setting range (min. value unit max. value)	Information
0 MS 30000	Lenze: 0, increment: 2 ms
<input checked="" type="checkbox"/> Read access <input checked="" type="checkbox"/> Write access <input type="checkbox"/> Controller inhibit <input type="checkbox"/> PLC-STOP <input type="checkbox"/> No transfer	

1.3.8.2 Activation

The function is activated or deactivated via the parameter value. A value > 0 activates the function, a value = 0 deactivates the function.

1.3.8.3 Fault analysis

This consideration applies to the SMS and SLS functions.

The evaluation and plausibility of the speed values is done in a cycle of 2 ms.

If the defined limit values are exceeded, the parameterised error response is activated within a time slot of maximally one evaluation cycle. With the error response SS1 or SS2 the response time of the stop function depends on the evaluation in the standard device. Moreover, the set stopping time must be added to the response time until the defined operating status is reached.

In order that the response can be checked for an error as quickly as possible, a maximum response time (C15350) can be parameterised. Before the maximum response time has elapsed, the detected speed must comply with the permissible (monitored) speed. If the permissible (monitored) speed is not complied with, STO is activated immediately.

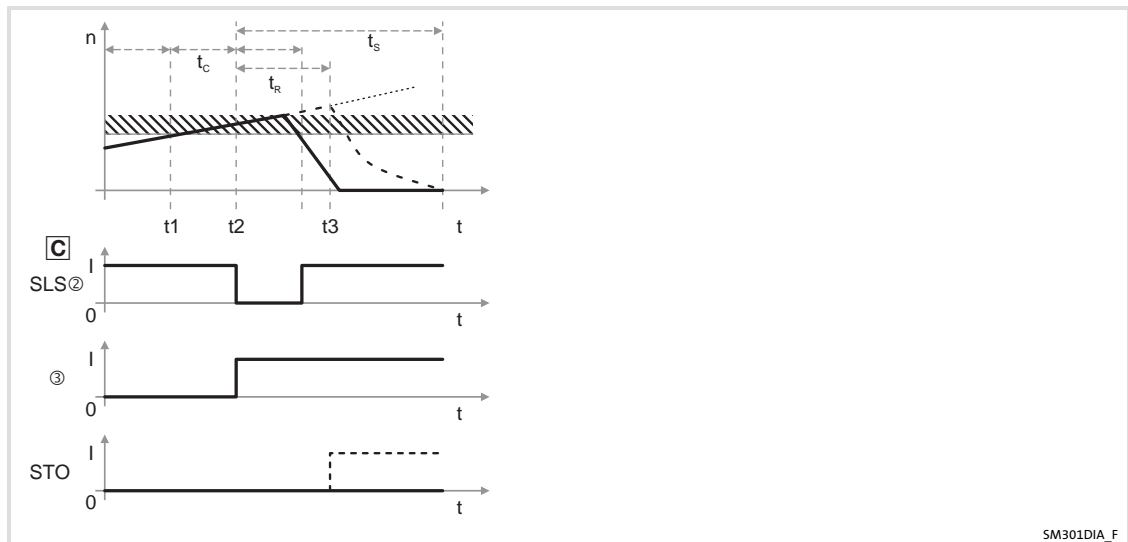

T1	Occurrence of the error event
t_c	Cycle time 2 ms
T2	Determining the error event
t_R	Maximum permissible response time (parameterisable)
t_3	Response instance to continuous exceedance
t_s	Stopping time
ⓐ	Feedback(s)
SLS②	SLS monitored
③	According to the error response set: SS2, SS1 or STO
STO	Response in case of an error after the max. response time has elapsed
—	Normal operation
- - - -	Incorrect operation



Note!

If the STO function has been selected as the error response for SMS or SLS, the internal response time is not considered because the motor is already coasting after the speed threshold is exceeded for the first time.

**Note!**

In case of an error, the set limited speed will be exceeded.

To assess the risk for the plant, you have to calculate the height of the maximum exceedance. Consider the following:

- ▶ internal response time
- ▶ application-specific response time
- ▶ application-specific maximum acceleration

1.3.9 Safely limited speed

1.3.9.1 Description

Safely Limited Speed/SLS

Safe Speed Monitor/SSM

After the adjustable braking time (C15331/1 ... 4) has elapsed, the function monitors the compliance with the reduced speed N_{lim} (C15330/1 ... 4).

► From SM301 V1.,1 four different speeds can be monitored (SLS1 ... SLS4).

When operating within the limit values, the "SLSx monitored" status is set (C15000). The status can be assigned to the safe output (C15052/1). The status can also be reported via the safety bus. From V1.3, feedback is returned as soon as the speed falls below its threshold. This results in reduced cycle times if the "SLSx monitored" feedback is used.

When the monitored speed is exceeded, a stop error is caused. STO, SS1 or SS2 (C15332/1...4) can be adjusted. If the speed is not within the limit values even after the adjustable response time (C15350), the drive will be directly switched off (STO).

The monitoring of the limited speed can be combined with a monitoring of the direction of rotation. For this purpose, the permissible direction of rotation for the corresponding limited speed SLSx must be set in parameter SLS: Permissible direction of rotation (C15333). This setting triggers two monitoring functions at the same time via one request (either via SD-InX or the safety bus).

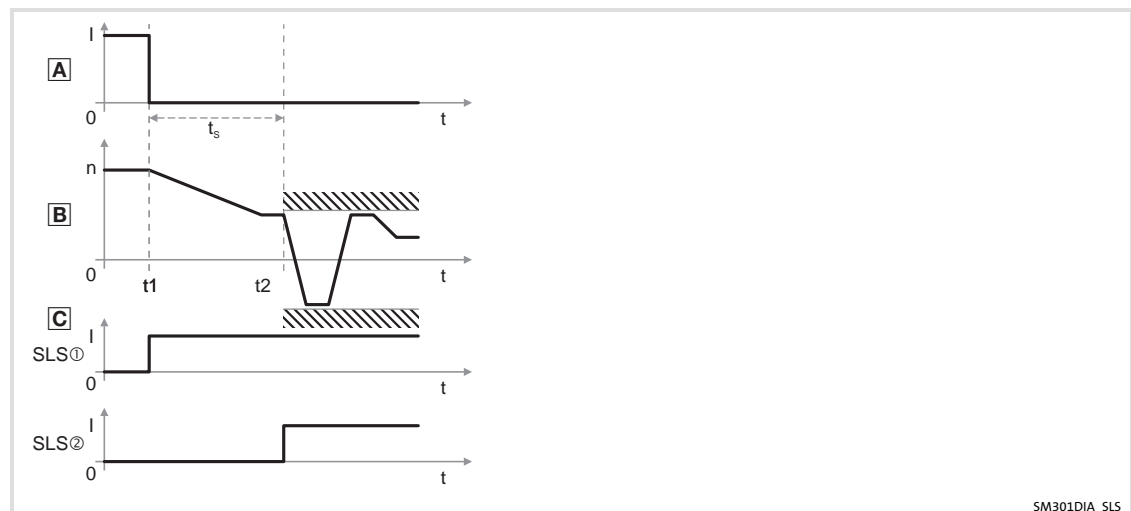

- A** Input signal of the request of a safety function
- I ON state
- 0 OFF state
- B** Speed characteristic n of the motor
- t Time axis
- t_x Action instant
- t_s Monitored braking time
- C** Feedback(s)
- SLS① SLS active
- SLS② SLS monitored

Codes

Parameter:	Name:	Data type:	Index:
C15330	SLS: Limited speed Nlim	UNSIGNED_16	9245 _d = 241D _h
Setting of the limited speed			
Setting range (min. value unit max. value)		Information	
0	rpm	16000	Lenze: 0
Subcodes		Information	
C15330/1		SLS1: Limited speed Nlim1	
C15330/2		SLS2: Limited speed Nlim2 (As of SM301 V1.1)	
C15330/3		SLS3: Limited speed Nlim3 (As of SM301 V1.1)	
C15330/4		SLS4: Limited speed Nlim4 (As of SM301 V1.1)	
<input checked="" type="checkbox"/> Read access <input type="checkbox"/> Write access <input type="checkbox"/> Controller inhibit <input type="checkbox"/> PLC-STOP <input type="checkbox"/> No transfer			
C15331	SLS: Braking time Nlim	UNSIGNED_16	9244 _d = 241C _h
Safely monitored time for braking the drive to the limited speed set in C15330.			
Setting range (min. value unit max. value)		Information	
0	MS	30000	Lenze: 0, increment: 2 ms
Subcodes		Information	
C15331/1		SLS1: Braking time Nlim1	
C15331/2		SLS2: Braking time Nlim2 (as of SM301 V1.1)	
C15331/3		SLS3: Braking time Nlim3 (as of SM301 V1.1)	
C15331/4		SLS4: Braking time Nlim4 (as of SM301 V1.1)	
<input checked="" type="checkbox"/> Read access <input type="checkbox"/> Write access <input type="checkbox"/> Controller inhibit <input type="checkbox"/> PLC-STOP <input type="checkbox"/> No transfer			
C15332	SLS: Response (n>Nlim)	UNSIGNED_8	9243 _d = 241B _h
Response in the safety module to the exceeding of the limited speed			
Selection list (Lenze setting bold)		Information	
0	STO	Safe torque off	
1	SS1	Safe stop 1	
2	SS2	Safe stop 2	
Subcodes		Information	
C15332/1		SLS1: Response (n>Nlim1)	
C15332/2		SLS2: Response (n>Nlim2) (as of SM301 V1.1)	
C15332/3		SLS3: Response (n>Nlim3) (as of SM301 V1.1)	
C15332/4		SLS4: Response (n>Nlim4) (as of SM301 V1.1)	
<input checked="" type="checkbox"/> Read access <input type="checkbox"/> Write access <input type="checkbox"/> Controller inhibit <input type="checkbox"/> PLC-STOP <input type="checkbox"/> No transfer			

Parameter:	Name:	Data type:	Index:
C15333	SLS: Permissible direction of movement	UNSIGNED_8	9242 _d = 241A _h
Permissible direction of movement during SLS monitoring			
Selection list (Lenze setting printed in bold)		Information	
0	Both directions enabled		
1	Positive direction enabled		
2	Negative direction enabled		
Subcodes		Information	
C15333/1		SLS1: Permissible direction of movement (from SM301 V1.3)	
C15333/2		SLS2: Permissible direction of movement (from SM301 V1.3)	
C15333/3		SLS3: Permissible direction of movement (from SM301 V1.3)	
C15333/4		SLS4: Permissible direction of movement (from SM301 V1.3)	
<input checked="" type="checkbox"/> Read access <input type="checkbox"/> Write access <input type="checkbox"/> Controller inhibit <input type="checkbox"/> PLC-STOP <input type="checkbox"/> No transfer			
C15350	SLS, SMS: Max. response time	UNSIGNED_16	9225 _d = 2409 _h
Maximum time after an exceeded speed has been detected, after which the speed must be below the limit again.			
Setting range (min. value unit max. value)		Information	
0	MS	30000	Lenze: 0, increment: 2 ms
<input checked="" type="checkbox"/> Read access <input type="checkbox"/> Write access <input type="checkbox"/> Controller inhibit <input type="checkbox"/> PLC-STOP <input type="checkbox"/> No transfer			

1.3.9.2

Activation

How to activate the function:

- ▶ "OFF state" at a safe input, the function of which has been assigned by parameter setting.
- ▶ Via a safety bus data telegram with corresponding content.

1.3.9.3

Fault analysis

The fault analysis is described with the SMS function (📖 69).

1 Safety engineering

Safety functions
Safe direction

1.3.10 Safe direction

1.3.10.1 Description

Safe Direction / SDI

This function monitors the safe compliance with an adjustable direction of rotation. The monitoring also includes zero speed with a tolerance window.

If the valid direction of rotation is not complied with, optionally SS1, SS2, or STO can be activated.

After the adjustable delay time has expired (C15341), the function monitors the compliance with the positive/negative direction of movement.

When operating within the limit values (C15342), the "SDIxxx monitored" status is set (C15000). The status can be assigned to the safe output (C15052/1). The status can also be reported via the safety bus.

If deviations from the permissible direction of movement occur, an error stop will be triggered. As an error response, STO, SS1, or SS2 can be set (C15343). In the event of an error the maximum change in position is displayed (C15344).

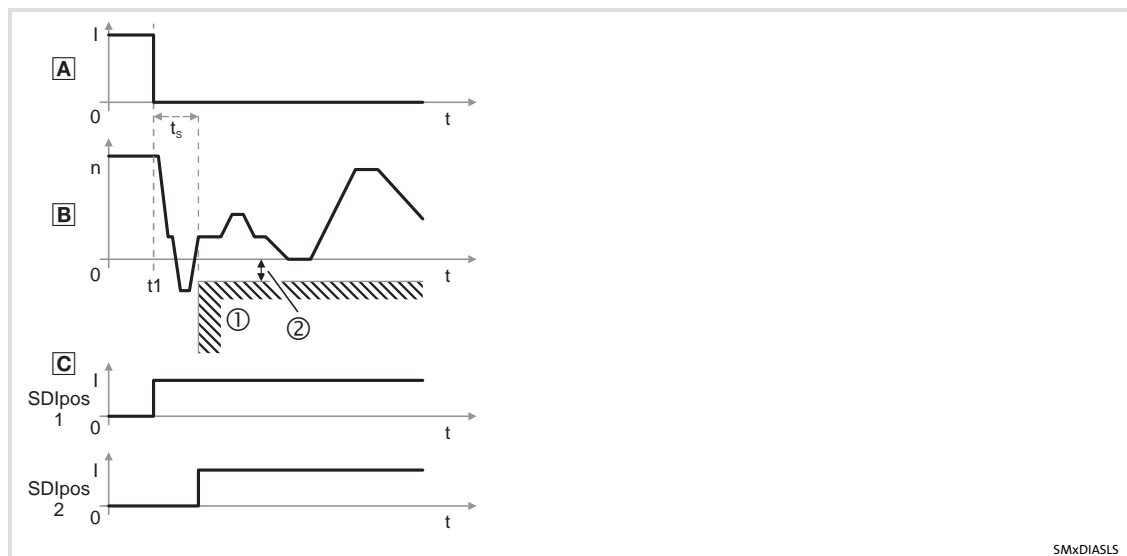

- A** Input signal of the request of a safety function
- '1' Logic signal level "1" / "TRUE"
- B** Direction of movement of the motor
- tx Action instant
- t Time axis
- ts Delay time
- C** Feedbacks
- SDIpos1 SDIpos active
- SDIpos2 SDIpos monitored
- ① Error response - triggering motion range
- ② Adjustable SDI tolerance threshold

**Note!**

If the SDI delay time (C15341) is parameterised greater than zero, either the "SDIxxx monitored" feedback must be evaluated (safety bus or safe output) or the risk analysis must show that the delay is not hazardous. This fact must e.g. be considered in the calculation of the safety clearance.

**Note!**

If the monitoring of the direction of movement, SDIxxx, is combined with function SLSx, the delay times must be coordinated. Then, braking time Nlim will start at the same time as the SDI delay time.

Codes

Parameter:	Name:	Data type:	Index:
C15340	SDI: Monitoring - normal operation	UNSIGNED_8	9235 _d = 2413 _h
Setting of the monitoring of the direction of movement of the motor during normal operation			
Selection list (read only)		Information	
0	Both directions enabled	(From SM301 V1.3)	
1	Positive direction enabled		
2	Negative direction enabled		
<input checked="" type="checkbox"/> Read access <input type="checkbox"/> Write access <input type="checkbox"/> Controller inhibit <input type="checkbox"/> PLC-STOP <input type="checkbox"/> No transfer			
Parameter:	Name:	Data type:	Index:
C15341	SDI: Deceleration time	UNSIGNED_16	9234 _d = 2412 _h
Safely monitored time from activation to switching on the monitoring SDIpos/SDIneg			
Display area (min. value unit max. value)		Information	
0	ms	30000	(From SM301 V1.3)
<input checked="" type="checkbox"/> Read access <input checked="" type="checkbox"/> Write access <input type="checkbox"/> Controller inhibit <input type="checkbox"/> PLC-STOP <input type="checkbox"/> No transfer			
Parameter:	Name:	Data type:	Index:
C15342	SDI: Tolerance threshold	UNSIGNED_32	9233 _d = 2411 _h
Setting of the tolerance threshold by how many increments the motor may move towards the direction inhibited through SDI			
Display area (min. value unit max. value)		Information	
0	Incr.	327680	(From SM301 V1.3)
<input checked="" type="checkbox"/> Read access <input checked="" type="checkbox"/> Write access <input type="checkbox"/> Controller inhibit <input type="checkbox"/> PLC-STOP <input type="checkbox"/> No transfer			
Parameter:	Name:	Data type:	Index:
C15343	SDI: Error response	UNSIGNED_8	9232 _d = 2410 _h
Response to a violation of the permitted direction of movement of the motor			
Selection list (read only)		Information	
0	STO	(From SM301 V1.3)	
1	SS1		
2	SS2		
<input checked="" type="checkbox"/> Read access <input checked="" type="checkbox"/> Write access <input type="checkbox"/> Controller inhibit <input type="checkbox"/> PLC-STOP <input type="checkbox"/> No transfer			
Parameter:	Name:	Data type:	Index:
C15344	SDI: Maximum change in position	UNSIGNED_32	9231 _d = 240F _h
Maximum change in position in inhibited direction if SDI is active			
Display area (min. value unit max. value)		Information	
0	Incr.	2147483647	
Subcodes		Information	
C15344/1		SDIpos: Maximum change in position (from SM301 V1.3)	
C15344/2		SDIneg: Maximum change in position (from SM301 V1.3)	
<input checked="" type="checkbox"/> Read access <input type="checkbox"/> Write access <input type="checkbox"/> Controller inhibit <input type="checkbox"/> PLC-STOP <input type="checkbox"/> No transfer			

1.3.10.2

Activation

How to activate the "Safe direction" function:

- ▶ Permanent monitoring of the direction of movement during normal operation (C15340).
- ▶ "OFF state" at a safe input, the function of which has been assigned by parameter setting.
- ▶ In conjunction with safely limited speed SLSx (C15333).
- ▶ Via a safety bus data telegram with corresponding content.

1.3.10.3 Fault analysis

This consideration is applies to function SDI.

The position values are evaluated and checked at a cycle of 2 ms. If the defined tolerance window is exceeded, the parameterised error response is triggered immediately within a time slot of max. one evaluation cycle. If a SS1 or SS2 error response is triggered, the response time of the stop function depends on the evaluation in the standard device. Furthermore, the set stopping time must be added to the response time until the defined operating status is reached. In the Lenze setting, the error response is set to SS1.

1 Safety engineering

Safety functions
Safe operation mode selector

1.3.11 Safe operation mode selector

1.3.11.1 Description

Operation Mode Selector / OMS

The function provides a special operation of the drive. In the special operation the drive is stopped (status 2). The drive can be traversed in the special operation via an enable switch (status 3).

For the stop status in the special operation, the STO, SS1 or SS2 functions can be parameterised.

For motion functions in the special operation, the SLS function (from V1.3 onwards combinable with SDI) or free movement (from V1.4 onwards combinable with SLI function) can be parameterised. The parameterised monitoring function will be automatically activated with the transition to the special operation.

The special operation enables an override of the simple STO, SS1, and SS2 stop functions by the enable switch.

Also in special operation, activated SMS, SDI and SLS monitoring functions are continued to be executed. An error detected in the monitoring functions, also in special operation, leads to the parameterised error stop function. Depending on the priority, the parameterised stop function of the monitoring function or the stop function of the special operation is executed without approval.

An active emergency stop function is also executed in special operation.

The special operation can also be selected via the safety bus by the F-PLC, unless a safe input is parameterised as operation mode selector.

The return to normal operation is only possible in the stop status. Since the drive is stopped in status 2, the AIS acknowledgement is required for restart. The parameters for the restart STO/SS1 or SS2 are used.



Note!

When returning to normal operation, the automatic restart is not permissible. If "automatic restart" is parameterised, this can be prevented by special measures, e.g. programming in the higher-level control.



Note!

The "safe enable switch" function serves to directly cancel/complete the stopping times assigned to the stop functions.



Note!

Monitoring of the safely limited increment (from SM301 V1.4 onwards) in special operation is active if a value > 0 has been selected for C15203.



Note!

If an error (e.g. a discrepancy error) occurs at a safe input to which the OMS function has been assigned, normal operation will be selected. This corresponds to the OFF state. The "ME" LED is blinking and STO is not activated. The special operation can only be selected again when the error has been eliminated and acknowledged.

From SM301 V1.3 onwards, the switching level at the digital input which determines special or normal operation can be set via the safe parameterisation.



Note!

When the OMS bit is received via the safety bus, the value 0 (normal operation) is assumed in case of passivation. In special applications (e.g. safety door, request of OMS, i.e. open safety door = special operation) this must not cause a dangerous state by automatic restart.

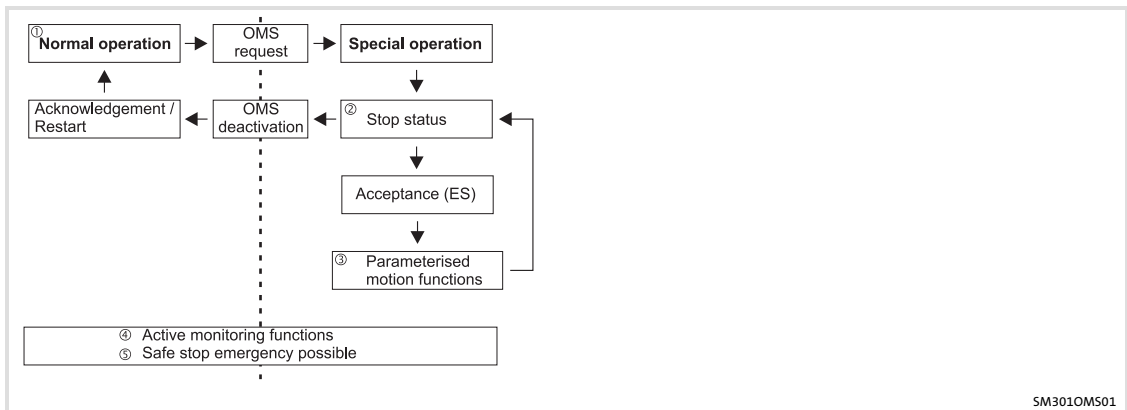

Operating mode	Normal	Special
Event	Impact	Impact
-	State ①	-
Request - OMS special operation via ...		
... safe input	Change →	State ② Stop function ... <ul style="list-style-type: none"> • STO • SS1 • SS2 ... is executed Activated monitoring functions remain active.
... safety bus	same response - only possible as an alternative to the safe input	
Request - ES confirmation via ...		
... safe input	No function	State ③ <ul style="list-style-type: none"> • Free movement • SLS (as of V1.3 combinable with SDI) possible as restriction • SLI (as of V1.4)
... via safety bus	same response - only possible as an alternative to the safe input	
Stop request	State ④ parameterised function ... <ul style="list-style-type: none"> • STO • SS1 • SS2 ... is executed	is not executed
Emergency stop	State ⑤ parameterised function ... <ul style="list-style-type: none"> • STO • SS1 ... is executed	
Monitoring responds: SMS SLS SDI	dependent on priority: parameterised error function ... <ul style="list-style-type: none"> • STO • SS1 • SS2 ... is executed or parameterised stopping function of special operation	

1.3.11.2 Conditions

A safe input must be parameterised and interconnected as an operation mode selector. Select the operating mode for the LOW level (C15202) depending on the application. Only one operation mode selector can be connected and parameterised. The OMS bit of the safety bus must be deactivated (C15113).

Special operation can also be selected via the safety bus (C15113) with the OMS bit if no safe input has been selected as an operation mode selector. In this case, at least one stop function must be parameterised via the safety bus to ensure that the drive system is safely switched-off if the bus should be interrupted. Furthermore, parameter C15202 must be set to "Normal operation".

The plausibility check rejects ambiguous settings until they are parameterised correctly.



Note!

The "free traversing" setting for the special operation (C15201) motion function must be suitable for the application!



Danger!

Dangerous situations may occur during automatic or special operation

Depending on the application, automatic or special operation may bring about hazardous situations.

Possible consequences:

- ▶ Injury to persons
- ▶ Damage to material assets

Protective measures:

- ▶ Must be observed in particular when setting the operating mode for the LOW level at the SD-Inx.
- ▶ Observe the notes provided in the attached application examples.

Codes

Parameter:	Name:	Data type:	Index:
C15200	OMS: Stop function	UNSIGNED_8	9375 _d = 249F _h
Selection of the stop function in special operation			
Selection list (Lenze setting bold)		Information	
0	STO	Safe torque off	
1	SS1	Safe stop 1	
2	SS2	Safe stop 2	
<input checked="" type="checkbox"/> Read access <input type="checkbox"/> Write access <input type="checkbox"/> Controller inhibit <input type="checkbox"/> PLC-STOP <input type="checkbox"/> No transfer			
Parameter:	Name:	Data type:	Index:
C15201	OMS: motion function	UNSIGNED_8	9374 _d = 249E _h
Selection of the motion function in special operation			
Selection list (Lenze setting bold)		Info	
3	SLS1	Safely limited speed 1 (Lenze setting up to SM301 V1.3)	
4	SLS2	Safely limited speed 2 (From SM301 V1.1)	
5	SLS3	Safely limited speed 3 (From SM301 V1.1)	
6	SLS4	Safely limited speed 4 (as of SM301 V1.1)	
11	Free traversing	(Lenze setting from SM301 V1.4)	
<input checked="" type="checkbox"/> Read access <input type="checkbox"/> Write access <input type="checkbox"/> Controller inhibit <input type="checkbox"/> PLC-STOP <input type="checkbox"/> No transfer			



Tip!

If SLSx has been parameterised as the motion function during special operation, a change to the acceptance operation is not possible until the reduced speed is monitored and maintained (SLSx monitored).

Parameter:	Name:	Data type:	Index:
C15202	OMS: Function at LOW level	UNSIGNED_8	9373 _d = 249D _h
Function that is executed in case of LOW level at the safe input with OMS function. Caution: According to the closed-circuit principle, the parameterisation must not cause any additional danger.			
Selection list (read only)		Information	
0	Normal operation	(From SM301 V1.3)	
1	Special operation		
<input checked="" type="checkbox"/> Read access <input type="checkbox"/> Write access <input type="checkbox"/> Controller inhibit <input type="checkbox"/> PLC-STOP <input type="checkbox"/> No transfer			
Parameter:	Name:	Data type:	Index:
C15203	SLI: Safely lim. increment	UNSIGNED_32	9372 _d = 249C _h
Number of increments for safely limited increment			
Setting range (min. value unit max. value)		Information	
0	Incr.	2147483647	Lenze: 1, deactivate: 0 (From SM301 V1.4)
<input checked="" type="checkbox"/> Read access <input type="checkbox"/> Write access <input type="checkbox"/> Controller inhibit <input type="checkbox"/> PLC-STOP <input type="checkbox"/> No transfer			
Parameter:	Name:	Data type:	Index:
C15204	SLI: Amount of position change	UNSIGNED_32	9371 _d = 249B _h
Maximum position change while SLI is active.			
Display area (min. value max. value)		Information	
0	Incr.	2147483647	(From SM301 V1.4)
<input checked="" type="checkbox"/> Read access <input type="checkbox"/> Write access <input type="checkbox"/> Controller inhibit <input type="checkbox"/> PLC-STOP <input type="checkbox"/> No transfer			

1.3.11.3 Activation

How to activate the function:

- ▶ Via a safe input which has been assigned to the function by parameterisation. In addition, the requested operating mode depends on OMS: Function at LOW level (C15202).

Example:

Normal operation at LOW level

The special operation is activated via a key-operated switch. The "Special operation with LOW level" function is not permissible for a key-operated switch which uses the special operation for short-circuiting purposes. An open circuit in the cable of the switch would activate the special operation which is otherwise only possible with a key.

Special operation at LOW level

The special operation is active if a safety grid (safety door) is opened, i.e. the safe input provides a LOW level and executes the parameterised stop function.

Only if no safe input is used, the function can only be activated via the safety bus:

- ▶ A data telegram with corresponding contents must be transmitted to the standard device.

1 Safety engineering

Safety functions
Safe enable switch

1.3.12 Safe enable switch

1.3.12.1 Description

Enable Switch / ES

The drive can be traversed in special operation using an enable switch (see operation mode selector).

1.3.12.2 Conditions

A safe input must be parameterised and interconnected as enable switch. You can only connect and parameterise one enable switch. The ES bit of the safety bus must be deactivated (C15113).

The enable switch function can also be selected via the safety bus with the ES bit, unless a safe input is parameterised as enable switch.

The special operation must be activated.

The plausibility check rejects ambiguous settings until they are parameterised correctly.

Codes

Parameter: C15031	Name: SD-In sensor function	Data type: UNSIGNED_8	Index: 9544 _d = 2548 _n
-----------------------------	---------------------------------------	--------------------------	---

Function configuration of the safe inputs.

- The "operation mode selector" and "enable switch" functions may only be assigned to one of the four safe inputs.

Selection list (Lenze setting printed in bold)	Information
0 Free assignment	Safety function set in C15032
1 Emergency stop	Safe stop emergency function (SSE)
2 Operation mode selector	Safe operation mode selector (OMS)
3 Enable switch	Safe enable switch (ES)
Subcodes	Information
C15031/1	SD-In1 sensor function
C15031/2	SD-In2 sensor function
C15031/3	SD-In3 sensor function
C15031/4	SD-In4 sensor function

Read access Write access Controller inhibit PLC-STOP No transfer

1.3.12.3 Activation

How to activate the function:

- ▶ Via a safe input which has been assigned to the function by parameterisation. With the edge change 0-1 of the ES signal, the status changes to "Acceptance (ES)".

Only if no safe input is used, the function can only be activated via the safety bus:

- ▶ A data telegram with corresponding contents must be transmitted to the standard device (edge change 0-1 of the ES signal).

1.3.13 Cascading

1.3.13.1 Description

Cascading / CAS

This function enables a synchronised shutdown of an entire drive system.

- ▶ The function can only be activated via parameter setting. For this purpose set the "CAS: cascading" parameter to "Cascading with SD-In4".
- ▶ With activated function:
 - The SD-In4 safe input is used as cascading input and cannot be used as universal input anymore.
 - The SD-Out1 safe output is used as cascading output and cannot be parameterised as universal feedback output anymore.
 - A stop function (emergency stop, SSE) released by cascading cannot be overruled in special operation through the enable switch.
- ▶ The cascade trips with every STO, irrespective of which safety module adopts the STO status and for which reason.
- ▶ All safety modules of the cascade can only be enabled if all cascading inputs (SD-In4) are in the OFF state (emergency stop has been enabled).
- ▶ For the restart of the drive system, the AIS restart acknowledgement must be executed simultaneously for all safety modules of the cascade.
- ▶ The restart is executed with a delay of 100 ms after the acknowledgement has been recognised.
- ▶ Cascading is designed for max. 100 drives.
- ▶ During special operation, the drives of the cascade can only change from the SS2/SOS stop function to acceptance. An STO or SS1 as stop function would trigger the entire drive system every time and thus impede acceptance.

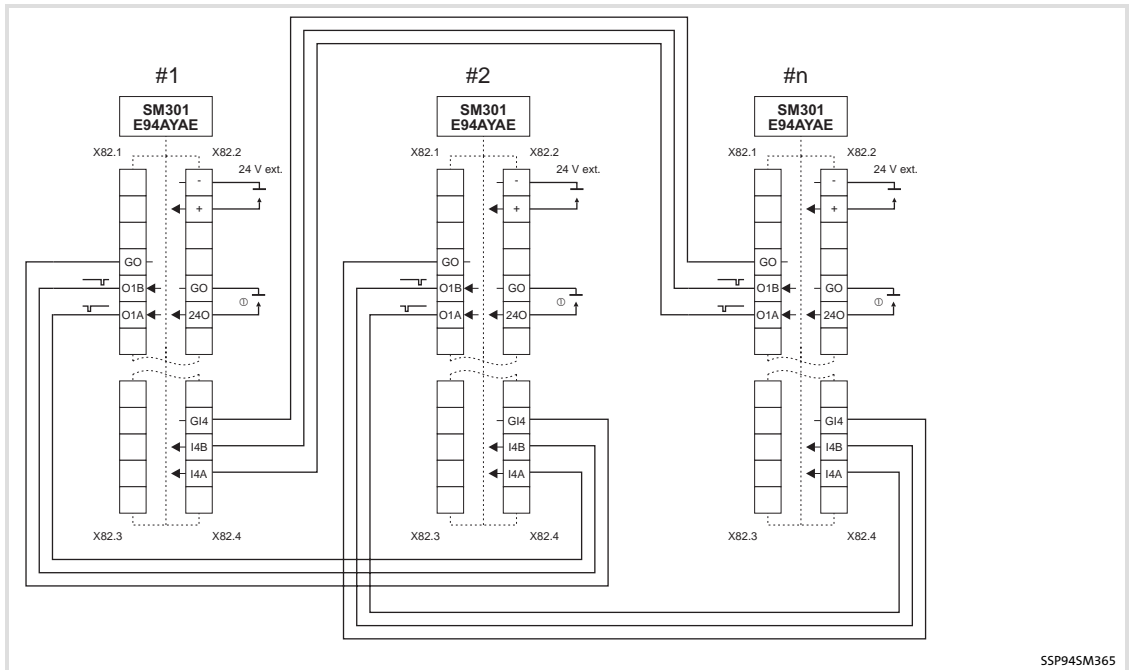

SSP94SM365

Fig. 1-11 Wiring example

E94AYAE
 #1, #2, #n
 24 V ext. ②
 ①

Safety module SM301 as of V1.1
 Number of the module
 24-V voltage supply of the module (SELV/PELV)
 24-V voltage supply of the output (SELV/PELV)

1.3.13.2 Conditions

- ▶ This function is available from SM301 V1.1.
- ▶ The SD-In4 input must be parameterised as active input for the "emergency stop" function and the input delay for SD-In4 must be ≤ 10 ms.
- ▶ The emergency stop function to be executed must be parameterised as STO via the "SSE: emergency stop function" parameter.
- ▶ The restart behaviour of the drive after the STO/SS1 stop function has been executed must be parameterised to "Acknowledged restart".
- ▶ The control of the SD-Out1 output via a possibly parameterised safety bus must be inhibited.
- ▶ The SS1 mode (C15306) must be set to "STO after stopping time".
- ▶ The plausibility check rejects other settings until they are parameterised correctly.

Codes

Parameter:	Name:	Data type:	Index:
C15035	CAS: Cascading	UNSIGNED_8	9540 _d = 2544 _h

Safe cascading

Selection list (Lenze setting bold)	Information
0 No cascading	(As of SM301 V1.1)
4 Cascading with SD-In4	

Read access Write access CINH PLC-STOP No transfer

Parameter:	Name:	Data type:	Index:
C15036	CAS: Stop delay	UNSIGNED_16	9539 _d = 2543 _h

Circulation time of safe cascading

Display area (min. value unit max. value)	Information
0 MS 65535	(As of SM301 V1.1)
	<ul style="list-style-type: none"> ● Display of the time that passes from switching the SD-Out1 output to OFF state to the detection of the OFF state at the SD-In4 input. This information may be helpful for system commissioning/maintenance. ● If "0 ms" is displayed after a stop, another safety module has activated the stop via the cascade. ● The time is displayed until the next system acknowledgement.

Read access Write access CINH PLC-STOP No transfer

1.3.13.3 Activation

The cascade trips with every STO, irrespective of which safety module adopts the STO status and for which reason.

1.4 Safety address

The safety address serves to clearly assign the safety modules of the SM301 type in systems with several drives. The address "0" is not permissible.

Address switch

The safety address can be set in the left part of the housing by means of the DIP switch . For setting the switch, use an appropriately small tool, e. g. a probe. The switch can only be set if the module is not connected to a standard device. Via the switch, addresses in the range of 0 ... 1023 can be set. Alterations by the switch with regard to the address are only activated when the 24-V supply is switched on. The address setting "0" requires the setting by the address code.

DIP switch 	Labelling									
	1	2	3	4	5	6	7	8	9	0
Value of the address bit	1	2	4	8	16	32	64	128	256	512

Tab. 1-5 Address setting

Address code

The safety address can also be set with the "Safety address" parameter (C15111) of the safety module. For this, the address setting via the DIP switch  must be set with the "0" setting. Via parameter, addresses can be set in a range of 0 ... 65534.

Effective safety address

The effective safety address is the result from the address switch or address parameter. The effective safety address must comply with the module ID assigned in the safe parameter set.

The effective safety address must also be used as target address by a master control with safety bus (e.g. PROFIsafe/PROFIsafe target address).

Module ID

(As of SM301 V1.2) Before the safe parameter set is downloaded, the system checks if the module ID defined in the parameter set corresponds to the module ID saved in the safety module. If the values are not the same, a corresponding message is displayed. This shall ensure that the safety address is not changed by mistake during parameter setting. If the user confirms the new value after checking it, the changed module ID will be saved non-volatile in the SM301. Code C15017 contains the module ID saved during the last parameter set transfer in the SM301.



Note!

A general reset does not change the stored module ID.

Codes

Parameter: C15017	Name: Stored module ID	Data type: UNSIGNED_16	Index: 9558 _d = 2556 _h
Module ID stored in the safety module			
Display area (min. value unit max. value)		Information	
0		65535	(As of SM301 V1.2) Default setting (invalid ID): 0 Stored ID defective: 65535
<input checked="" type="checkbox"/> Read access <input type="checkbox"/> Write access <input type="checkbox"/> Controller inhibit <input type="checkbox"/> PLC-STOP <input type="checkbox"/> No transfer			
Parameter: C15101	Name: Display - DIP switch position	Data type: UNSIGNED_16	Index: 9474 _d = 2502 _h
Display of the DIP switch position			
Display area (min. value unit max. value)		Information	
0		1023	
<input checked="" type="checkbox"/> Read access <input type="checkbox"/> Write access <input type="checkbox"/> Controller inhibit <input type="checkbox"/> PLC-STOP <input type="checkbox"/> No transfer			
Parameter: C15111	Name: Safety address	Data type: UNSIGNED_16	Index: 9464 _d = 24F8 _h
Safety address parameterised in the safety module			
Setting range (min. value unit max. value)		Information	
0		65534	Lenze: 0
<input checked="" type="checkbox"/> Read access <input checked="" type="checkbox"/> Write access <input type="checkbox"/> Controller inhibit <input type="checkbox"/> PLC-STOP <input type="checkbox"/> No transfer			
Parameter: C15112	Name: Effective safety address	Data type: UNSIGNED_16	Index: 9463 _d = 24F7 _h
Address used in safety module			
Display area (min. value unit max. value)		Information	
1		65534	
<input checked="" type="checkbox"/> Read access <input type="checkbox"/> Write access <input type="checkbox"/> Controller inhibit <input type="checkbox"/> PLC-STOP <input type="checkbox"/> No transfer			

1 Safety engineering

Safe bus interfaces
PROFIsafe connection

1.5 Safe bus interfaces

In the safety module, parameterised interfaces are provided for standardised safety bus systems. With the selection of the bus system, the corresponding parameters are made available.

Currently supported communication types:

- ▶ Operation without safety bus system
- ▶ Operation with PROFIsafe protocol

Codes

Parameter: C15100	Name: S bus: Configuration	Data type: UNSIGNED_8	Index: 9475 _d = 2503 _h
Configuration of the safety bus			
Selection list (Lenze setting bold)		Information	
0	No safety bus		
1	PROFIsafe / PROFIBUS		
2	PROFIsafe / PROFINET	(As of SM301 V1.1)	
<input checked="" type="checkbox"/> Read access <input type="checkbox"/> Write access <input type="checkbox"/> Controller inhibit <input type="checkbox"/> PLC-STOP <input type="checkbox"/> No transfer			

1.5.1 PROFIsafe connection

1.5.1.1 Conditions

The SM301 supports the transmission of safe information on the PROFIsafe protocol according to the "PROFIsafe - Profile for Safety Technology" specification, version 1.30, of the PROFIBUS Nutzerorganisation (PNO). The SM301 V1.1 also supports the PROFIsafe protocol according to the "PROFIsafe - Profile for Safety Technology" specification, version 2.x. The standard device transmits the PROFIsafe information to the safety module for safe evaluation.

PROFIsafe connection	Required communication module	Setting "S BUS: Configuration" (C15100)
PROFIBUS	E94AYCPM (PROFIBUS-DP) as of software version V1.00	PROFIsafe / PROFIBUS
PROFINET (as of SM301 V1.1)	E94AYCER (PROFINET) as of software version V0.70	PROFIsafe / PROFINET



Note!

A safety bus system (PROFIsafe) can only be operated via the upper module slot (MXI1) of the Servo Drive 9400.



Note!

The operation with PROFIsafe via PROFINET is only permissible according to the "PROFIsafe - Profile for Safety Technology" specification, version 2.x.

1.5.1.2 Description

Addressing

In order that a data telegram reaches the correct node, an unambiguous PROFIsafe target address is required. If PROFIsafe has been selected as safety bus, the safety address is simultaneously accepted as PROFIsafe target address. This address must comply with the corresponding configuration of the safety PLC.

PROFIsafe frame

The PROFIsafe message is sent in the first slot of a PROFIBUS data telegram or in the second slot of a PROFINET data telegram.

This must be observed for the hardware configuration of the safety PLC!

PROFIBUS data telegram			
Header	PROFIsafe data	Data	Trailer
	Slot 1	Slot 2	

PROFINET data telegram (as of SM301 V1.1)			
Header	PROFIsafe data	Data	Trailer
	Slot 2	Slot 1	

PROFIsafe data

In the PROFIsafe data one bit each is used to control a certain safety function.

- ▶ The structure of the PROFIsafe message is described in the PROFIsafe profile.
- ▶ The length of the PROFIsafe message in the SM301 is eight bytes (fixed).

The PROFIsafe messages are structured according to the following system:

PROFIsafe message - V1 mode								
Byte offset	Bit offset							
	7	6	5	4	3	2	1	0
0	PROFIsafe process data PROFIsafe output data/PROFIsafe input data							
1								
2								
3								
4	Control byte or status byte							
5	Consecutive number							
6	CRC2							
7	(Signature consists of PROFIsafe process data and PROFIsafe parameters)							

PROFIsafe message - V2 mode (as of SM301 V1.1)								
Byte offset	Bit offset							
	7	6	5	4	3	2	1	0
0	PROFIsafe process data PROFIsafe output data/PROFIsafe input data							
1								
2								
3								
4	Control byte or status byte							
5	CRC2 (Signature consists of PROFIsafe process data and PROFIsafe parameters and the consecutive number)							
6								
7								

Tab. 1-6 Structure of the PROFIsafe data

The meaning of the PROFIsafe process data is separately described for PROFIsafe output data and PROFIsafe input data. All bits described are evaluated.

Unassigned bits are reserved for future functions and marked with "-". These bits must be transmitted with "0".

PROFIsafe output data

The PROFIsafe output data is transmitted from the control to the safety module.

Control word PROFIsafe output data (safe user data)			
Bit	Name	Value	Description
0	STO	0	The STO function is activated.
1	SS1	0	The SS1 function is activated.
2	SS2	0	The SS2 function is activated.
3	SLS1	0	The SLS1 function is activated.
4	SLS2	0	The SLS2 function is activated. (from SM301 V1.1)
5	SLS3	0	The SLS3 function is activated. (from SM301 V1.1)
6	SLS4	0	The SLS4 function is activated. (from SM301 V1.1)
7	SDIpos	0	The SDIpos function is activated. (from SM301 V1.3)
8	SDIneg	0	The SDIneg function is activated. (from SM301 V1.3)
9	ES	1	Acceptance active: In special operation -> motion functions are possible.
11	OMS	0	Normal operation
		1	Special operation
16	PS_AIS	0 → 1	Activation of restart acknowledgement The bit must be set for at least one PROFIsafe cycle.
17	PS_AIE	0 → 1	Activation of fault acknowledgement The bit must be set for at least one PROFIsafe cycle.
23	SSE	0	The SSE function is activated.
24	SD-Out1	0	The SD-Out1 output is set to the OFF state.
-	-	0	Reserved for future extensions

Tab. 1-7 Detailed specification of the PROFIsafe output data

Control byte

For the PROFIsafe V1 mode only the indicated bits of the PROFIsafe control byte are supported:

Assignment				Bit				
Byte	7	6	5	4	3	2	1	0
4	-	-	-	activate_FV	-	-	-	-

Tab. 1-8 Structure of the PROFIsafe control byte in V1 mode

Bit coding - control byte			
Bit	Name	Value	Description
4	activate_FV	1	The PROFIsafe output data is passivated.
	-	0	Reserved for future extensions

Tab. 1-9 Detailed specification of the control byte in V1 mode

For the PROFIsafe V2 mode only the indicated bits of the PROFIsafe control byte are supported:

Assignment				Bit				
Byte	7	6	5	4	3	2	1	0
4	-	-	Toggle_h	activate_FV	-	R_cons_nr	-	-

Tab. 1-10 Structure of the PROFIsafe control byte in V2 mode

Bit coding - control byte			
Bit	Name	Value	Description
2	R_cons_nr	1	Reset of the consecutive number.
4	activate_FV	1	The PROFIsafe output data is passivated.
5	Toggle_h	1/0	Change increases the consecutive number.
	-	0	Reserved for future extensions

Tab. 1-11 Detailed specification of the control byte in V2 mode

Control data filter

Unused functions in the control data of the safety bus must be set to "Inhibit" via the parameter "S-bus: Control data filter" (C15113). After this, the functions can no longer be activated via the safety bus independently of the transferred control data. As of SM301 V1.2, the filtered control data is indicated in "S-bus: Display of control data" (C15115).

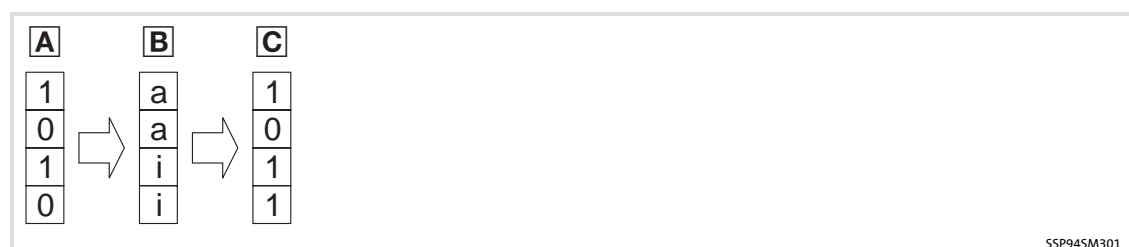

Fig. 1-12 Function example - filter

- Ⓐ Control data, incoming (0 = active, 1 = inactive)
- Ⓑ Control data filter
(Selection in the »Engineer«: a = "pass through", i = "inhibit")
- Ⓒ Effective control data (0 = active, 1 = inactive)

Codes

Parameter:	Name:	Data type:	Index:
C15113	S-Bus: Filter control data	BITFIELD_32	9462 _d = 24F6 _h
Bit coded selection of the active bit positions in the safety bus control data			
Value is bit coded:		Information	
Bit 0	STO	Safe torque off	
Bit 1	SS1	Safe stop 1	
Bit 2	SS2	Safe stop 2	
Bit 3	SLS1	Safely limited speed 1	
Bit 4	SLS2	Safely limited speed 2 (From SM301 V1.1)	
Bit 5	SLS3	Safely limited speed 3 (From SM301 V1.1)	
Bit 6	SLS4	Safely limited speed 4 (From SM301 V1.1)	
Bit 7	SDIpos	Safe positive direction (From SM301 V1.3)	
Bit 8	SDIneg	Safe negative direction (From SM301 V1.3)	
Bit 9	ES	Safe enable switch	
Bit 10	Reserved		
Bit 11	OMS	Safe operation mode selector	
Bit 12	Reserved		
...			
Bit 15	Reserved		
Bit 16	PS_AIS	Restart acknowledgement via safety bus	
Bit 17	PS_AIE	Fault acknowledgement via safety bus	
Bit 18	Reserved		
...			
Bit 22	Reserved		
Bit 23	SSE	Emergency stop function	
Bit 24	SD-Out1	Safe output	
Bit 25	Reserved		
...			
Bit 31	Reserved		

Read access
 Write access
 Controller inhibit
 PLC-STOP
 No transfer

Parameter: C15115	Name: S-bus: Control data display	Data type: BITFIELD_32	Index: 9460 _d = 24F4 _h
-----------------------------	---	---------------------------	---

Display of safety bus control data after filtering via C15113

Value is bit coded:		Information
		(From SM301 V1.2)
Bit 0	STO	Safe torque off
Bit 1	SS1	Safe stop 1
Bit 2	SS2	Safe stop 2
Bit 3	SLS1	Safely limited speed 1
Bit 4	SLS2	Safely limited speed 2
Bit 5	SLS3	Safely limited speed 3
Bit 6	SLS4	Safely limited speed 4
Bit 7	SDIpos	Safe positive direction (From SM301 V1.3)
Bit 8	SDIneg	Safe negative direction (From SM301 V1.3)
Bit 9	ES	Safe enable switch
Bit 10	Reserved	
Bit 11	OMS	Safe operation mode selector
Bit 12	Reserved	
...		
Bit 15	Reserved	
Bit 16	PS_AIS	Restart acknowledgement via safety bus
Bit 17	PS_AIE	Fault acknowledgement via safety bus
Bit 18	Reserved	
...		
Bit 22	Reserved	
Bit 23	SSE	Emergency stop function
Bit 24	SD-Out1	Safe output
Bit 25	Reserved	
...		
Bit 31	Reserved	

Read access Write access Controller inhibit PLC-STOP No transfer

PROFIsafe input data

The safety module transmits the PROFIsafe input data to the controller. This can be displayed via "Safety function status" (C15000).

Bit coding of PROFIsafe input data		
Bit	Name	Description
0	STO active	The STO function is active and the drive is safely switched to torque-free operation. This bit is also set at the end of the stopping time by SS1.
1	SS1 active	The SS1 function is active. At the end of the function the STO bit is set.
2	SS2 active	The SS2 function is active. At the end of the function the SOS bit is set.
3	SLS1 active	The SLS1 function is active. At the end of the function the SLS1_monitored bit is set in addition.
4	SLS2 active	The SLS2 function is active. At the end of the function, bit SLS2_monitored is set in addition. (as of SM301 V1.1)
5	SLS3 active	The SLS3 function is active. At the end of the function, bit SLS3_monitored is set in addition. (as of SM301 V1.1)
6	SLS4 active	The SLS4 function is active. At the end of the function, bit SLS4_monitored is set in addition. (as of SM301 V1.1)
7	SDIpos is active	The SDIpos function is active. After the deceleration time has expired, bit 21 (SDIpos monitored) is set in addition. (As of SM301 V1.3)
8	SDIneg is active	The SDIneg function is active. After the deceleration time has expired, bit 22 (SDIneg monitored) is set in addition. (As of SM301 V1.3)
9	ES active	1: ES function in special operation is active: Motion function 0: ES function in special operation is not active: Stop function
10	SLI is active	The safely limited increment (SLI) function is active. (As of SM301 V1.4)
11	OMS	1: special operation requested 0: normal operation
16	SOS monitored	The SOS function is monitored.
17	SLS1 monitored	The SLS1 function is monitored.
18	SLS2 monitored	The SLS2 function is monitored. (as of SM301 V1.1)
19	SLS3 monitored	The SLS3 function is monitored. (as of SM301 V1.1)
20	SLS4 monitored	The SLS4 function is monitored. (as of SM301 V1.1)
21	SDIpos is monitored	The SDIpos function is active, the compliance with the direction of movement is monitored. (As of SM301 V1.3)
22	SDIneg is monitored	The SDIneg function is active, the compliance with the direction of movement is monitored. (As of SM301 V1.3)
23	SSE active	The SSE function is monitored. At the end of the function the STO or SS1 bit is set according to the emergency stop function parameterised.
24	SD-In1	Sensor at I1A and I1B Channels A and B are in the ON state
25	SD-In2	Sensor at I2A and I2B Channels A and B are in the ON state
26	SD-In3	Sensor at I3A and I3B Channels A and B are in the ON state
27	SD-In4	Sensor at I4A and I4B Channels A and B are in the ON state
29	OMS active	Special operation is not active. (as of SM301 V1.1)
31	Error active	Error status (i.e trouble or warning) is active.

Tab. 1-12 Detailed specification of the PROFIsafe input data

Status byte

For the PROFIsafe V1 mode only the indicated bits of the PROFIsafe status byte are supported:

Assignment				Bit				
Byte	7	6	5	4	3	2	1	0
4	-	-	-	FV_activated	COM-Failure WD-Timeout	COM-Failure CRC	-	-

Tab. 1-13 Structure of the PROFIsafe status byte in V1 mode

Bit coding - status byte		
Bit	Name	Description
2	COM-Failure CRC	Status after communication error is active.
3	COM-Failure WD-Timeout	Status after time-out is active.
4	FV_activated	The PROFIsafe input data is deactivated.
-	-	Reserved for future extensions

Tab. 1-14 Detailed specification of the status byte in V1 mode

For the PROFIsafe V2 mode only the indicated bits of the PROFIsafe status byte are supported:

Assignment				Bit				
Byte	7	6	5	4	3	2	1	0
4	-	cons_nr_R	Toggle_d	FV_activated	WD_timeout	CE_CRC	-	-

Tab. 1-15 Structure of the PROFIsafe status byte in V2 mode

Bit coding - status byte		
Bit	Name	Description
2	CE_CRC	Status after communication error is active.
3	WD_timeout	Status after time-out is active.
4	FV_activated	The PROFIsafe input data is deactivated.
5	Toggle_d	Change shows increase of the consecutive number.
6	cons_nr_R	Consecutive number has been reset.
-	-	Reserved for future extensions

Tab. 1-16 Detailed specification of the status byte in V2 mode

PROFIsafe parameters

These PROFIsafe parameters and contents are supported:

PROFIsafe parameters		
Name	Description	Valid contents
F_Source_Add	PROFIsafe source address of the safety PLC	0x01 ... 0xFFFE
F_Dest_Add	PROFIsafe target address of the safety module	DIP switch: 0x01 ... 0x03FF Code: 0x01 ... 0xFFFE
F_WD_Time	PROFIsafe monitoring time of the safety module	110 ... 65535 ms
F_Check_SeqNo	Check sequence no. in CRC	V1 mode: 0 V2 mode: not relevant
F_Check_iPar	Check iparameters CRC3 in CRC	0
F_SIL	Supported SIL (Safety Integrity Level)	SIL1: 0 SIL2: 1 SIL3: 2
F_CRC_Length	Length of CRC	V1 mode/2-byte-CRC: 1 V2 mode/3-byte-CRC: 0
F_Block_ID	Identification of the parameter type	0
F_Par_Version	Version of the safety layer	V1 mode: 0 V2 mode: 1
F_Par_CRC	Cyclic CRC	Is calculated

Tab. 1-17 Supported PROFIsafe parameters

Diagnostic messages

Incorrect configurations of the PROFIsafe parameters are reported to the safety PLC by means of a diagnostic telegram (see PROFIBUS or PROFINET Communication Manual).

Diagnostic information

Error number	Description
64	The Profisafe target address set does not comply with the parameter F_Dest_Add.
65	The F_Dest_Add parameter has the invalid value 0x0000 or 0xFFFF.
66	The F_Source_Add parameter has the invalid value 0x0000 or 0xFFFF.
67	The F_WD_Time parameter has the invalid value 0 ms.
68	The F_SIL parameter does not have the valid value 0 ... 2.
69	The F_CRC_Length parameter does not have the valid value 1.
70	The version of the PROFIsafe parameter set is wrong.
71	CRC1 error

Tab. 1-18 Information contents of byte 11

More error messages are listed in the appendix.

GSE file

The GSE file contains all information on the configuration of the PROFIBUS system. This makes the integration easy and user-friendly.

GSDML file

The GSDML file contains all information on the configuration of the PROFINET system (As of SM301 V1.1). This makes the integration easy and user-friendly.

1 Safety engineering

Safe parameter setting
Parameter setting

1.6 Safe parameter setting



Note!

During online communication via bus system, multiple users can access the very same drive at the same time and edit the safe parameter set. After the safe parameter set has been transmitted, please check if the checksums (CRC) of the parameter set, memory module, and safety module in the "Safe transfer" dialog are consistent.

The consistency of the safe parameters must be ensured by organisational measures because there are no technical means to avoid multiple users accessing parameter sets at the same time.

1.6.1 Parameter setting

Safety-relevant parameters can exclusively be transmitted to the safety module by safe parameter setting. The parameter set is saved in the memory module and safety module with a definite module ID which must comply with the effective safety address in the safety module.

A safe parameter setting requires the service status. The service status means the following:

- ▶ The standard stop is active and the drive is safely switched to torqueless operation (STO).
- ▶ The communication via the safety bus is active but passivated.

About the service status:

- ▶ It can be activated by the Lenze »Engineer« PC software.
- ▶ It can be quit by reinitialising the module, i.e. the communication via the safety module is interrupted.



Note!

The service status also occurs if the parameter set in the memory module does not comply with the parameter set in the safety module during initialisation.

Observe the information on compatibility of the SM301 firmware versions ( 19).

1.6.1.1 Parameter setting with the Lenze »Engineer« PC software

Safe parameter setting is supported by the Lenze PC software »Engineer« as of version 1.4.

The parameter setting is described in the Software Manual for the SM301 safety module. Moreover, the software provides a comprehensive Online Help.

Password

For storing a safe parameter set, a password is required. The standard password is: "Lenze SM301". The password can be changed and must have at least six characters.

Use "general reset" to delete the safe parameter set in the memory module and the safety module. The safety module must be reparameterised.

The password is reset to the standard "Lenze SM301".

1.6.1.2 Parameter set transfer from the memory module

The safe parameter set transfer is supported by a safe parameter set stored in the memory module, e.g. in case of a module exchange.

- ▶ A valid parameter set with a corresponding module ID must be stored.
- ▶ The safety module must be in the service status.

The transfer of the parameter set from the memory module must be acknowledged at the safety module.

- ▶ The "MS" LED is flashing (safety module is in service status.)
- ▶ "AS" LED is lit
- ▶ Press module switch S82 and keep it pressed
- ▶ "AS" LED starts blinking
- ▶ When the "AS" LED goes off, release the S82 module switch immediately
- ▶ The "AS" LED is lit again after a short time
- ▶ Press again the S82 module switch and keep it pressed
- ▶ "AS" LED starts blinking
- ▶ When the "AS" LED goes off, release the S82 module switch immediately
- ▶ The parameter set transfer is completed successfully.

If system-related response times (approx. 2.5 s) cannot be complied with, the parameter transfer is cancelled. The process must be started again.

In case of success, the parameter transfer is recorded in the logbook of the standard device and the service status is quit by a software restart.

If the parameter set is invalid, an error is indicated and the "ME" LED is blinking.

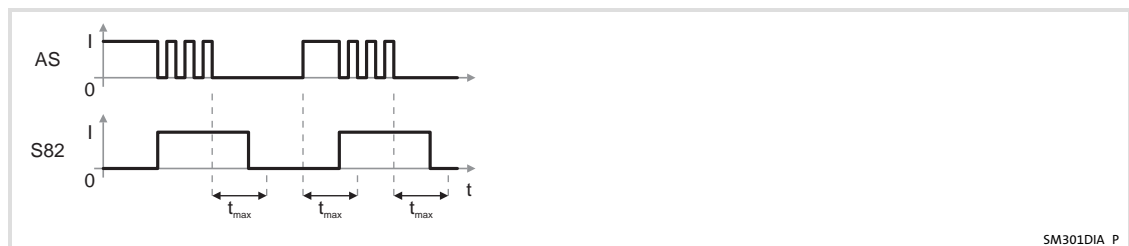

Fig. 1-13 Acknowledgement procedure

AS	AS light-emitting diode
S82	S82 module switch
t	Time axis
t _{max}	Maximum permissible response time

1 Safety engineering

Safe parameter setting
Parameter sets and axes

1.6.2 Parameter sets and axes

The individuality of an axis with safety functions in a drive system can be achieved by means of the safety address. In the safe parameter set a module ID is stored. This module ID is compared to the effective safety address (C15112) in the safety module.

When a safety module is initialised, i.e. when the parameter set is loaded, the compliance of the safety address will be checked. If no compliance exists, an initialisation error is reported.



Note!

- ▶ Clearly define the safety address in a drive system or plant.
- ▶ Document the address in circuit diagrams and labels.
- ▶ Ensure identical settings when replacing the module.

In drive systems with activated safety bus the safety address is also used as safety bus target address. The clear assignment of the safety address must be configured in the safety PLC.

In drive systems without activated safety bus, individuality and correct assignment of the safety address must be checked. For this, use the Lenze »Engineer« PC software or an E94AZK... keypad.

Codes

Parameter:	Name:	Data type:	Index:
C15112	Effective safety address	UNSIGNED_16	9463 _d = 24F7 _h
Address used in safety module			
Display area (min. value unit max. value)		Information	
1		65534	
<input checked="" type="checkbox"/> Read access <input type="checkbox"/> Write access <input type="checkbox"/> Controller inhibit <input type="checkbox"/> PLC-STOP <input type="checkbox"/> No transfer			

1.7 Error management

1.7.1 Error states

Detected errors or maloperation of the drive are assigned to error statuses with definite reactions. The reaction can be co-ordinated with the complete drive via the error statuses.

Features	Error status		
	System error	Trouble	Warning
Event	Fatal internal error	Fault	Monitoring function
LED "ME"	On	Blinking	Flashing
Status of safety module	Lockout (CPU stopped)	Error status	Normal operation
The control category according to EN ISO 13849-1 has been abandoned	... has been abandoned	... has not been abandoned
Response	The motor immediately switches to torque-free operation via <ul style="list-style-type: none"> • STO 	The motor is stopped via <ul style="list-style-type: none"> • STO or • SS1 	
Acknowledgement after deactivated event	<ul style="list-style-type: none"> • Connection and disconnection of the 24-V supply at the safety module 	<ul style="list-style-type: none"> • Fault acknowledgement (AIE) via terminal X82.2 (positive signal pulse with a signal time of 0.3 ... 10 s) • Fault acknowledgement (AIE) via the safety bus (Bit "PS_AIE") • Connection and disconnection of the 24-V supply at the safety module 	

Tab. 1-19 Overview of error statuses

More error messages are listed in the appendix.



Note!

If the system fault also occurs after switching the 24-V supply, please contact the service.

When using PROFIsafe as safety bus:

- ▶ If faults occur in the PROFIsafe communication, the data is passivated by the PROFIsafe driver.
- ▶ After the PROFIsafe communication is reinitialised, the drive is automatically enabled again if no standstill function is selected.
- ▶ Events which cause an error status are sent as diagnostic telegram via the safety bus.

1.7.2 Logbook function in the controller

Error states are saved in the logbook of the standard device. The following is entered:

- ▶ Type of response (e.g. trouble, warning, or information) to the event
- ▶ Date/time (in case of memory module with real-time clock)
- ▶ Value of the power-on time meter

The available logbook entries can be displayed in the »Engineer« when an online connection has been established.

The list of the error entries can be found in the appendix.

1.7.3 Logbook function in the SM301

For diagnostic purposes, a simple logbook with ten entries is implemented in the SM301 V1.4. Here, changes regarding the request of safety functions in the SM301 are logged. The basis for the logbook is the bit-coded log state generated in a 2-ms cycle. A logbook is generated every time the log state changes.

- ▶ The logbook function can be controlled via the "Log function" (C15891).
 - The parameter can be written without using the safe parameter setting interface.
- ▶ A logbook entry consists of the two corresponding subcodes of the parameters "Log time" (C15892) and "Log state" (C15893).



Note!

Before the display parameters of the logbook are read for diagnostic purposes, the logbook function should be stopped in order to prevent inconsistency (C15891 = 1).

Codes

Parameter: C15890	Name: Current time	Data type: UNSIGNED_32	Index: 8685 _d = 21ED _h
-----------------------------	------------------------------	---------------------------	---

Relative time for use in logbook.

Display area (min. value unit max. value)			Information
0	ms	4294967295	(From SM301 V1.4)

Read access Write access Controller inhibit PLC-STOP No transfer

Parameter: C15891	Name: Log function	Data type: UNSIGNED_8	Index: 8684 _d = 21EC _h
-----------------------------	------------------------------	--------------------------	---

Setting of the logging behaviour (trigger condition). (From SM301 V1.4)

Selection list		Information
0	Logging is active	Logging is always active.
1	Logging is stopped	Logging is switched off.
2	Stop logging in case of error	Logging is stopped if an error occurs.
3	Stop logging in case of STO	Logging is stopped if STO occurs.
4	Stop logging in case of SS1	Logging is stopped if SS1 occurs.
5	Stop logging in case of SS2	Logging is stopped if SS2 occurs.

Read access Write access Controller inhibit PLC-STOP No transfer

Parameter: C15892	Name: Log time	Data type: UNSIGNED_32	Index: 8683 _d = 21EB _h
Time of log entry.			
Display area (min. value unit max. value)		Information	
0	ms	4294967295	(From SM301 V1.4)
Subcodes		Information	
C15892/1		Log time n	
C15892/2		Log time n-1	
...			
C15892/10		Log time n-9	
<input checked="" type="checkbox"/> Read access <input type="checkbox"/> Write access <input type="checkbox"/> Controller inhibit <input type="checkbox"/> PLC-STOP <input type="checkbox"/> No transfer			
Parameter: C15893	Name: Log state	Data type: BITFIELD_64	Index: 8682 _d = 21EA _h
Logged state			
Display area		Information	
-	-	-	(As of SM301 V1.4)
Value is bit-coded		Information	
Bit 0	Bit-coded log states	Detailed information can be found in the appendix	
...			
Bit 63			
Subcodes		Information	
C15893/1		Log state n	
C15893/2		Log state n-1	
...			
C15893/10		Log state n-9	
<input checked="" type="checkbox"/> Read access <input type="checkbox"/> Write access <input type="checkbox"/> Controller inhibit <input type="checkbox"/> PLC-STOP <input type="checkbox"/> No transfer			

1.8 Response times

In order to detect the response time to a safety function the entire system must be considered. The following is relevant:

- ▶ Response time of the connected sensors.
- ▶ Input delay of the safety inputs.
- ▶ Internal processing time.
- ▶ When using PROFIsafe as safety bus:
 - Monitoring time for the cyclic service in the PROFIBUS/PROFINET.
 - Monitoring time of the PROFIsafe in the safety PLC.
 - Processing time in the safety PLC.
- ▶ Delay times due to further components.

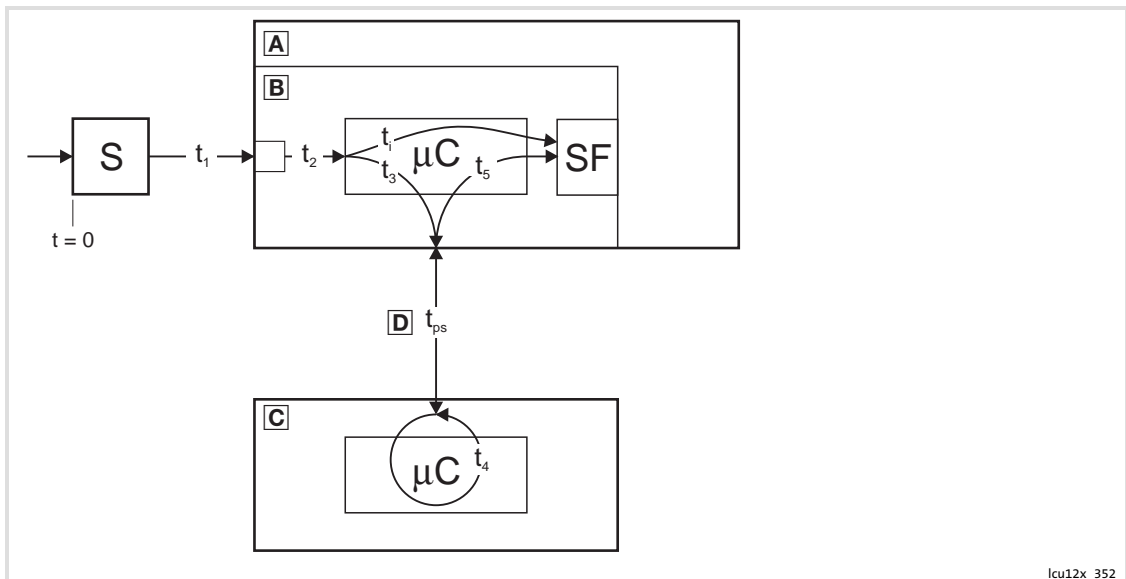

Fig. 1-14 Response times to the request of a safety function

- ▣ A Standard device
- ▣ B Safety module
- ▣ C Safety PLC
- ▣ D Safety bus
- μC Microcontroller
- S Safety sensor technology
- SF Activated safety function

1.8.1 Response times of the inputs

Response time to an event in the sensors		[ms]
Time interval (Fig. 1-14)		
t ₁	Response time of the sensors	according to manufacturer information
t ₂	Input delay of the safe inputs	C15034: 0 ... 100
		Input error: 2
t _i	Processing time in drive-based safety	4
Safety function starts after ...		Σ

Tab. 1-20 Response time to an event in the sensors

1.8.2 Response time of the safe output

Response time of the safe output to a safety function		[ms]
	Safe output SD-Out1 switches to ...	4

Tab. 1-21 Response time - safe output

1.8.3 Response times of the safety bus

PROFIsafe

Response time to an event in the safety sensors (PROFIsafe input data)		[ms]
Time interval (Fig. 1-14)		
t ₁	Response time of the sensors	according to manufacturer information
t ₂	Input delay of the safe inputs	C15034: 0 ... 100
		Input error: 2
t ₃	Processing time in drive-based safety	24
PROFIsafe input data ready for transmission to ...		Σ
t _{ps}	PROFIsafe cycle time	according to manufacturer information
PROFIsafe input data ready for processing in the safety PLC ...		Σ

Tab. 1-22 Response time to an event in the sensors

Response time to a PROFIsafe control word (PROFIsafe output data)		[ms]
Time interval (Fig. 1-14)		
t_4	Processing time in the safety PLC	must be calculated
t_{p5}	PROFIsafe cycle time	according to manufacturer information
t_5	Processing time in drive-based safety	14
	Safety function starts after ...	Σ

Tab. 1-23 Response time in case of PROFIsafe request

Information on how to calculate the processing time and transmission time of the PROFIsafe can be found in the documentation of the safety PLC used.



Note!

When the PROFIsafe communication is disturbed, it is changed to the fail-safe state after the PROFIsafe monitoring time (F_WD_Time) has elapsed (Tab. 1-17). The PROFIsafe communication is passivated.

Example

- ▶ After an event has occurred at a safe input, the message is fed back to drive-based safety via the safety PLC.
- ▶ Drive-based safety activates a safety function.
- ▶ Hence, the maximum response time to the event is calculated as follows:

$$t_{\max \text{ response}} = t_1 + t_2 + t_3 + \max \{t_{WD}; t_{p5} + t_4 + t_{p5} + t_5\}$$

When calculating the maximum response time, include the times of the safety functions, e.g. in case of SS1 the stopping time (C15305) until STO is active.

1.8.4

Response time of encoder monitoring

Response time of encoder monitoring		[ms]
Time required to detect faults due to continuous signal errors at the encoder interface.	(As of SM301 V1.2) can be parameterised under C15410	12
		12/50/100



Note!

The minimum response time must be individually determined for each system. A longer response time leads to an increased system availability, if, for instance, during machine set-up with safe operating stop process-related speed jumps occur for a short time.

1.9 Acceptance

1.9.1 Description

The machine manufacturer must check and prove the operability of the safety functions used.

Inspector

The machine manufacturer must authorise a person with expertise and knowledge of the safety functions to carry out the test.

Test report

The test result of every safety function must be documented and signed by the inspector.



Note!

If parameters of the safety functions are changed, the inspector must repeat the test and record the results in the test report.

Scope of test

A complete test comprises the following:

- ▶ Documenting the plant including the safety functions:
 - Creating an overview screen of the plant
 - Describing the plant
 - Describing the safety equipment
 - Documenting the safety functions used
- ▶ Checking the function of the safety functions used:
 - "Safe torque off" function, STO
 - "Safe stop 1" function, SS1
 - "Safe stop 2" function, SS2
 - "Safe operating stop" function, SOS
 - "Safe maximum speed" function, SMS
 - "Safely limited speed" function, SLS
 - "Safe stop emergency" function, SSE
 - "Safe direction" function, SDI
 - "Safely limited increment" function, SLI
- ▶ Preparing the test report:
 - Documenting the functional test
 - Checking the parameters
 - Signing the test report
- ▶ Preparing the appendix with test records:
 - Protocols from the plant
 - External recording

1 Safety engineering

Acceptance

Periodic inspections

1.9.2 Periodic inspections

The correct sequence of the safety-oriented functions must be checked in periodic inspections. The risk analysis or applicable regulations determine the time distances between the tests. The inspection interval should not exceed one year.

1.10 Appendix

1.10.1 Module internal codes

This chapter contains all parameters of the SM301 safety module in numerically ascending order.

- ▶ Standard values are printed in bold type or with the "Lenze:" addition.
- ▶ The write access is marked with  if the codes can only be set via the safe parameter setting.

Parameter:	Name:	Data type:	Index:
C15000	Status of safety functions	BITFIELD_32	9575 _d = 2567h
Bit coded status word of the safety functions			
Value is bit coded:		Information	
Bit 0	STO active	Safe torque off	
Bit 1	SS1 active	Safe stop 1	
Bit 2	SS2 active	Safe stop 2	
Bit 3	SLS1 active	Safely limited speed 1	
Bit 4	SLS2 active	Safely limited speed 2 (From SM301 V1.1)	
Bit 5	SLS3 active	Safely limited speed 3 (From SM301 V1.1)	
Bit 6	SLS4 active	Safely limited speed 4 (From SM301 V1.1)	
Bit 7	SDIpos is active	Safe direction, positive (From SM301 V1.3)	
Bit 8	SDIneg is active	Safe direction, negative (From SM301 V1.3)	
Bit 9	ES active	Safe enable switch	
Bit 10	SLI is active	Safely limited increment (From SM301 V1.4)	
Bit 11	OMS	Safe operation mode selector	
Bit 12	Reserved		
...			
Bit 15	Reserved		
Bit 16	SOS monitored	Safe operational stop is monitored.	
Bit 17	SLS1 monitored	Safely limited speed 1 is monitored.	
Bit 18	SLS2 monitored	Safely limited speed 2 is monitored. (From SM301 V1.1)	
Bit 19	SLS3 monitored	Safely limited speed 3 is monitored. (From SM301 V1.1)	
Bit 20	SLS4 monitored	Safely limited speed 4 is monitored. (as of SM301 V1.1)	
Bit 21	SDIpos is monitored	Safe positive direction is monitored. (From SM301 V1.3)	
Bit 22	SDIneg is monitored	Safe negative direction is monitored. (From SM301 V1.3)	
Bit 23	SSE active	Emergency stop function	
Bit 24	SD-In1 active	Safe input	
Bit 25	SD-In2 active	Safe input	
Bit 26	SD-In3 active	Safe input	
Bit 27	SD-In4 active	Safe input	
Bit 28	Reserved		
Bit 29	OMS active	Special operation is active (as of SM301 V1.1)	
Bit 30	Reserved		
Bit 31	Error active		
<input checked="" type="checkbox"/> Read access <input type="checkbox"/> Write access <input type="checkbox"/> Controller inhibit <input type="checkbox"/> PLC-STOP <input type="checkbox"/> No transfer			

Parameter: C15003	Name: Command status	Data type: UNSIGNED_16	Index: 9572 _d = 2564 _h
-----------------------------	--------------------------------	---------------------------	---

Status of the current command.

- In high byte the command is repeated.
- In low byte the status is displayed:
 - 0x00: no command
 - 0x01: command executed
 - 0x02: password invalid
 - 0x03: command in process
 - 0x04: command unknown
 - 0x05: command error

Display area (min. value unit max. value)	Information
0	2309
<input checked="" type="checkbox"/> Read access <input type="checkbox"/> Write access <input type="checkbox"/> Controller inhibit <input type="checkbox"/> PLC-STOP <input type="checkbox"/> No transfer	

Parameter: C15010	Name: Parameter set status	Data type: UNSIGNED_8	Index: 9565 _d = 255D _h
-----------------------------	--------------------------------------	--------------------------	---

Status of the parameter set

Selection list (read only)	Information
0	No parameter set
1	Parameter set valid
2	Read error - memory module
3	Parameter set dissimilar
4	CRC error
5	Version error
6	Format error
7	Plausibility error
8	Assignment error
9	Local read error
10	Communication error GG
<input checked="" type="checkbox"/> Read access <input type="checkbox"/> Write access <input type="checkbox"/> Controller inhibit <input type="checkbox"/> PLC-STOP <input type="checkbox"/> No transfer	

Parameter: C15011	Name: Parameter CRC	Data type: UNSIGNED_32	Index: 9564 _d = 255C _h
-----------------------------	-------------------------------	---------------------------	---

Parameter checksum (CRC = Cyclic Redundancy Code)

Display area (min. value unit max. value)	Information
0	4294967295
Subcodes	Information
C15011/1	CRC safety module
C15011/2	CRC memory module
<input checked="" type="checkbox"/> Read access <input type="checkbox"/> Write access <input type="checkbox"/> Controller inhibit <input type="checkbox"/> PLC-STOP <input type="checkbox"/> No transfer	

Parameter: C15013	Name: Time for parameter set creation	Data type: UNSIGNED_64	Index: 9562 _d = 255A _h
-----------------------------	---	---------------------------	---

Time of parameter set creation

Display area (min. value unit max. value)	Information
0	1844674407370 96E+19
<input checked="" type="checkbox"/> Read access <input type="checkbox"/> Write access <input type="checkbox"/> Controller inhibit <input type="checkbox"/> PLC-STOP <input type="checkbox"/> No transfer	

Parameter: C15014	Name: Time - RTC parameter setting	Data type: VISIBLE_STRING	Index: 9561 _d = 2559 _h
-----------------------------	--	------------------------------	---

Time of parameter set transfer from the memory module as a value of the real-time clock (RTC).

Parameter: C15015	Name: Time sec. parameter setting	Data type: UNSIGNED_32	Index: 9560 _d = 2558 _h
-----------------------------	---	---------------------------	---

Time of parameter set transfer from the memory module as a value of the power-on time meter from the controller.

Display area (min. value unit max. value)	Information
0	S 4294967295
<input checked="" type="checkbox"/> Read access <input type="checkbox"/> Write access <input type="checkbox"/> Controller inhibit <input type="checkbox"/> PLC-STOP <input type="checkbox"/> No transfer	

Parameter: C15016	Name: Parameter set version	Data type: UNSIGNED_8	Index: 9559 _d = 2557 _h
-----------------------------	---------------------------------------	--------------------------	---

Display of the parameter set version in the safety module.

Selection list (read only)		Information
0	No current parameter set	
1	Parameter set V1.0	(From SM301 V1.1)
2	Parameter set V1.1	
3	Parameter set V1.2	(From SM301 V1.2)
4	Parameter set V1.3	(From SM301 V1.3)
5	Parameter set V1.4	(From SM301 V1.4)

Read access Write access Controller inhibit PLC-STOP No transfer

Parameter: C15017	Name: Stored module ID	Data type: UNSIGNED_16	Index: 9558 _d = 2556 _h
-----------------------------	----------------------------------	---------------------------	---

Module ID stored in the safety module

Display area (min. value unit max. value)		Information
0	65535	(As of SM301 V1.2) Default setting (invalid ID): 0 Stored ID defective: 65535

Read access Write access Controller inhibit PLC-STOP No transfer

Parameter: C15030	Name: SD-In sensor type	Data type: UNSIGNED_8	Index: 9545 _d = 2549 _h
-----------------------------	-----------------------------------	--------------------------	---

Configuration of the sensor types which are connected to the safe inputs.

Selection list (Lenze setting bold)		Information
0	Input deactivated	
1	Passive sensor	
2	Active sensor	

Subcodes		Information
C15030/1		SD-In1 sensor type
C15030/2		SD-In2 sensor type
C15030/3		SD-In3 sensor type
C15030/4		SD-In4 sensor type

Read access Write access Controller inhibit PLC-STOP No transfer

Parameter: C15031	Name: SD-In sensor function	Data type: UNSIGNED_8	Index: 9544 _d = 2548 _h
-----------------------------	---------------------------------------	--------------------------	---

Function configuration of the safe inputs.

- The "operation mode selector" and "enable switch" functions may only be assigned to one of the four safe inputs.

Selection list (Lenze setting printed in bold)		Information
0	Free assignment	Safety function set in C15032
1	Emergency stop	Safe stop emergency function (SSE)
2	Operation mode selector	Safe operation mode selector (OMS)
3	Enable switch	Safe enable switch (ES)

Subcodes		Information
C15031/1		SD-In1 sensor function
C15031/2		SD-In2 sensor function
C15031/3		SD-In3 sensor function
C15031/4		SD-In4 sensor function

Read access Write access Controller inhibit PLC-STOP No transfer

Parameter: C15032	Name: SD-In free assignment	Data type: UNSIGNED_8	Index: 9543 _d = 2547 _h
-----------------------------	---------------------------------------	--------------------------	---

Assignment of a safety function to a safe input.

- Only possible if the "free assignment" sensor function is set for the safe input in C15031.

Selection list (Lenze setting printed in bold)	Information
0 STO	Safe torque off
1 SS1	Safe stop 1
2 SS2	Safe stop 2
3 SLS1	Safely limited speed 1
4 SLS2	Safely limited speed 2 (from SM301 V1.1)
5 SLS3	Safely limited speed 3 (from SM301 V1.1)
6 SLS4	Safely limited speed 4 (from SM301 V1.1)
7 SDIpos	Safe positive direction (from SM301 V1.3)
8 SDIneg	Safe negative direction (from SM301 V1.3)
9 No function	No (local) safety function assigned. <ul style="list-style-type: none"> • Functional test and monitoring of the discrepancy time are active. • The input status is transferred to the control via the safety bus (if parameterised).
Subcodes	Information
C15032/1	Free assignment SD-In1
C15032/2	Free assignment SD-In2
C15032/3	Free assignment SD-In3
C15032/4	Free assignment SD-In4

Read access Write access Controller inhibit PLC-STOP No transfer

Parameter: C15033	Name: SD-In discrepancy time	Data type: UNSIGNED_16	Index: 9542 _d = 2546 _h
-----------------------------	--	---------------------------	---

Maximum time in which both channels of a safe input may have non-equivalent states without the safety engineering causing an error response.

Setting range (min. value unit max. value)	Information
0 MS 30000	Lenze: 10, increment: 2 ms
Subcodes	Information
C15033/1	SD-In1 discrepancy time
C15033/2	SD-In2 discrepancy time
C15033/3	SD-In3 discrepancy time
C15033/4	SD-In4 discrepancy time

Read access Write access Controller inhibit PLC-STOP No transfer

Parameter: C15034	Name: SD-In input delay	Data type: UNSIGNED_8	Index: 9541 _d = 2545 _h
-----------------------------	-----------------------------------	--------------------------	---

Time between the recognition of the signal change and the effective evaluation of an input signal. As a result, multiple and short signal changes due to contact bounce of the components are not taken into account.

Setting range (min. value unit max. value)	Information
0 MS 100	Lenze: 0, increment: 2 ms
Subcodes	Information
C15034/1	Input delay SD-In1
C15034/2	Input delay SD-In2
C15034/3	Input delay SD-In3
C15034/4	Input delay SD-In4

Read access Write access Controller inhibit PLC-STOP No transfer

Parameter:	Name:	Data type:	Index:
C15035	CAS: Cascading	UNSIGNED_8	9540 _d = 2544 _h

Safe cascading

Selection list (Lenze setting bold)	Information
0 No cascading	(As of SM301 V1.1)
4 Cascading with SD-In4	

Read access Write access CINH PLC-STOP No transfer

C15036	CAS: Stop delay	UNSIGNED_16	9539 _d = 2543 _h
---------------	------------------------	-------------	---------------------------------------

Circulation time of safe cascading

Display area (min. value unit max. value)	Information
0 MS 65535	(As of SM301 V1.1)
	<ul style="list-style-type: none"> • Display of the time that passes from switching the SD-Out1 output to OFF state to the detection of the OFF state at the SD-In4 input. This information may be helpful for system commissioning/maintenance. • If "0 ms" is displayed after a stop, another safety module has activated the stop via the cascade. • The time is displayed until the next system acknowledgement.

Read access Write access CINH PLC-STOP No transfer

C15040	Input image	BITFIELD_32	9535 _d = 253F _h
---------------	--------------------	-------------	---------------------------------------

Input image of the external module inputs of the safety module, shown in channels.

Value is bit coded:	Information
Bit 0 SD-In1 channel A	Safe input 1
Bit 1 SD-In1 channel B	
Bit 2 SD-In2 channel A	Safe input 2
Bit 3 SD-In2 channel B	
Bit 4 SD-In3 channel A	Safe input 3
Bit 5 SD-In3 channel B	
Bit 6 SD-In4 channel A	Safe input 4
Bit 7 SD-In4 channel B	
Bit 8 reserved	
...	
Bit 15 reserved	
Bit 16 AIE	AIE input (fault acknowledgement)
Bit 17 AIS	AIS input (restart acknowledgement)
Bit 18 Module switch	
Bit 19 reserved	
...	
Bit 31 reserved	

Read access Write access Controller inhibit PLC-STOP No transfer

Parameter:	Name:	Data type:	Index:
C15051	SD-Out condition	BITFIELD_32	9524 _d = 2534 _h
Bit coded selection of the conditions for switching the safe output.			
Value is bit coded:		Information	
Bit 0	STO active	Safe torque off	
Bit 1	STO active neg. logic		
Bit 2	SS1 active	Safe stop 1	
Bit 3	SS1 active neg. logic		
Bit 4	SS2 active	Safe stop 2	
Bit 5	SS2 active neg. logic		
Bit 6	SLS1 active	Safely limited speed 1	
Bit 7	SLS1 active neg. logic		
Bit 8	SLS2 active	Safely limited speed 2 (From SM301 V1.1)	
Bit 9	SLS2 active neg. logic		
Bit 10	SLS3 active	Safely limited speed 3 (From SM301 V1.1)	
Bit 11	SLS3 active neg. logic		
Bit 12	SLS4 active	Safely limited speed 4 (as of SM301 V1.1)	
Bit 13	SLS4 active neg. logic		
Bit 14	SDIpos is active	Safe direction, positive (From SM301 V1.3)	
Bit 15	SDIpos active neg. logic		
Bit 16	SDIneg is active	Safe direction, negative (From SM301 V1.3)	
Bit 17	SDIneg active neg. logic		
Bit 18	ES active	Safe enable switch	
Bit 19	ES active neg. logic		
Bit 20	SLI is active	Safely limited increment (From SM301 V1.4)	
Bit 21	SLI active neg. logic		
Bit 22	OMS	Safe operation mode selector	
Bit 23	OMS neg. logic		
Bit 24	Reserved		
...			
Bit 31	Reserved		
Subcodes		Information	
C15051/1		SD-Out1 switching condition	
<input checked="" type="checkbox"/> Read access <input type="checkbox"/> Write access <input type="checkbox"/> Controller inhibit <input type="checkbox"/> PLC-STOP <input type="checkbox"/> No transfer			

Parameter: C15052	Name: SD-Out condition	Data type: BITFIELD_32	Index: 9523 _d = 2533 _h
-----------------------------	----------------------------------	---------------------------	---

Bit coded selection of the conditions for switching the safe output.

Value is bit coded:	Information	
Bit 0	SOS monitored	Safe operational stop is monitored.
Bit 1	SOS monitors neg. logic	Safe operational stop is not monitored.
Bit 2	SLS1 monitored	Safely limited speed 1 is monitored.
Bit 3	SLS1 monitored neg. logic	Safely limited speed 1 is not monitored.
Bit 4	SLS2 monitored	Safely limited speed 2 is monitored. (from SM301 V1.1)
Bit 5	SLS2 monitors neg. logic	Safely limited speed 2 is not monitored. (from SM301 V1.1)
Bit 6	SLS3 monitored	Safely limited speed 3 is monitored. (from SM301 V1.1)
Bit 7	SLS3 monitors neg. logic	Safely limited speed 3 is not monitored. (from SM301 V1.1)
Bit 8	SLS4 monitored	Safely limited speed 4 is monitored. (from SM301 V1.1)
Bit 9	SLS4 monitors neg. logic	Safely limited speed 4 is not monitored. (from SM301 V1.1)
Bit 10	SDIpos monitored	Safe positive direction is monitored. (from SM301 V1.3)
Bit 11	SDIpos monitors neg. logic	Safe positive direction is not monitored. (from SM301 V1.3)
Bit 12	SDIneg monitored	Safe negative direction is monitored. (from SM301 V1.3)
Bit 13	SDIneg monitors neg. logic	Safe negative direction is not monitored. (from SM301 V1.3)
Bit 14	SSE active	Emergency stop function
Bit 15	SSE active neg. logic	
Bit 16	SD-In1 active	Safe inputs
Bit 17	SD-In1 active neg. logic	
Bit 18	SD-In2 active	
Bit 19	SD-In2 active neg. logic	
Bit 20	SD-In2 active	
Bit 21	SD-In2 active neg. logic	
Bit 22	SD-In4 active	
Bit 23	SD-In4 active neg. logic	
Bit 24	Reserved	
Bit 25	Reserved	
Bit 26	OMS active	Special operation is active (from SM301 V1.1)
Bit 27	OMS active neg. logic	Special operation is not active (from SM301 V1.1)
Bit 28	Reserved	
Bit 29	Reserved	
Bit 30	Error active	
Bit 31	Error active neg. logic	

Subcodes	Information
C15052/1	SD-Out1 switching condition

Read access Write access Controller inhibit PLC-STOP No transfer

Parameter: C15055	Name: SD-Out logic function	Data type: UNSIGNED_8	Index: 9520 _d = 2530 _h
-----------------------------	---------------------------------------	--------------------------	---

Selection of the logic operation for the switching conditions to be evaluated

Selection list (Lenze setting bold)	Information
0 OR	
1 AND	

Subcodes	Information
C15055/1	SD-Out1 logic function

Read access Write access Controller inhibit PLC-STOP No transfer

Parameter: C15060	Name: Output image	Data type: BITFIELD_16	Index: 9515 _d = 252B _h
Output image of the safety module feedback, shown in channels.			
Value is bit coded:		Information	
Bit 0	SD-Out1 channel A	Safe output 1	
Bit 1	SD-Out1 channel B		
Bit 2	reserved		
...			
Bit 15	reserved		
<input checked="" type="checkbox"/> Read access <input type="checkbox"/> Write access <input type="checkbox"/> Controller inhibit <input type="checkbox"/> PLC-STOP <input type="checkbox"/> No transfer			
Parameter: C15100	Name: S bus: Configuration	Data type: UNSIGNED_8	Index: 9475 _d = 2503 _h
Configuration of the safety bus			
Selection list (Lenze setting bold)		Information	
0	No safety bus		
1	PROFIsafe / PROFIBUS		
2	PROFIsafe / PROFINET	(As of SM301 V1.1)	
<input checked="" type="checkbox"/> Read access <input checked="" type="checkbox"/> Write access <input type="checkbox"/> Controller inhibit <input type="checkbox"/> PLC-STOP <input type="checkbox"/> No transfer			
Parameter: C15101	Name: Display - DIP switch position	Data type: UNSIGNED_16	Index: 9474 _d = 2502 _h
Display of the DIP switch position			
Display area (min. value unit max. value)		Information	
0		1023	
<input checked="" type="checkbox"/> Read access <input type="checkbox"/> Write access <input type="checkbox"/> Controller inhibit <input type="checkbox"/> PLC-STOP <input type="checkbox"/> No transfer			
Parameter: C15111	Name: Safety address	Data type: UNSIGNED_16	Index: 9464 _d = 24F8 _h
Safety address parameterised in the safety module			
Setting range (min. value unit max. value)		Information	
0		65534	Lenze: 0
<input checked="" type="checkbox"/> Read access <input checked="" type="checkbox"/> Write access <input type="checkbox"/> Controller inhibit <input type="checkbox"/> PLC-STOP <input type="checkbox"/> No transfer			
Parameter: C15112	Name: Effective safety address	Data type: UNSIGNED_16	Index: 9463 _d = 24F7 _h
Address used in safety module			
Display area (min. value unit max. value)		Information	
1		65534	
<input checked="" type="checkbox"/> Read access <input type="checkbox"/> Write access <input type="checkbox"/> Controller inhibit <input type="checkbox"/> PLC-STOP <input type="checkbox"/> No transfer			

Parameter:	Name:	Data type:	Index:
C15113	S-Bus: Filter control data	BITFIELD_32	9462 _d = 24F6 _h
Bit coded selection of the active bit positions in the safety bus control data			
Value is bit coded:		Information	
Bit 0	STO	Safe torque off	
Bit 1	SS1	Safe stop 1	
Bit 2	SS2	Safe stop 2	
Bit 3	SLS1	Safely limited speed 1	
Bit 4	SLS2	Safely limited speed 2 (From SM301 V1.1)	
Bit 5	SLS3	Safely limited speed 3 (From SM301 V1.1)	
Bit 6	SLS4	Safely limited speed 4 (From SM301 V1.1)	
Bit 7	SDIpos	Safe positive direction (From SM301 V1.3)	
Bit 8	SDIneg	Safe negative direction (From SM301 V1.3)	
Bit 9	ES	Safe enable switch	
Bit 10	Reserved		
Bit 11	OMS	Safe operation mode selector	
Bit 12	Reserved		
...			
Bit 15	Reserved		
Bit 16	PS_AIS	Restart acknowledgement via safety bus	
Bit 17	PS_AIE	Fault acknowledgement via safety bus	
Bit 18	Reserved		
...			
Bit 22	Reserved		
Bit 23	SSE	Emergency stop function	
Bit 24	SD-Out1	Safe output	
Bit 25	Reserved		
...			
Bit 31	Reserved		

Read access
 Write access
 Controller inhibit
 PLC-STOP
 No transfer

Parameter: C15115	Name: S-bus: Control data display	Data type: BITFIELD_32	Index: 9460 _d = 24F4 _h
-----------------------------	---	---------------------------	---

Display of safety bus control data after filtering via C15113

Value is bit coded:		Information
		(From SM301 V1.2)
Bit 0	STO	Safe torque off
Bit 1	SS1	Safe stop 1
Bit 2	SS2	Safe stop 2
Bit 3	SLS1	Safely limited speed 1
Bit 4	SLS2	Safely limited speed 2
Bit 5	SLS3	Safely limited speed 3
Bit 6	SLS4	Safely limited speed 4
Bit 7	SDIpos	Safe positive direction (From SM301 V1.3)
Bit 8	SDIneg	Safe negative direction (From SM301 V1.3)
Bit 9	ES	Safe enable switch
Bit 10	Reserved	
Bit 11	OMS	Safe operation mode selector
Bit 12	Reserved	
...		
Bit 15	Reserved	
Bit 16	PS_AIS	Restart acknowledgement via safety bus
Bit 17	PS_AIE	Fault acknowledgement via safety bus
Bit 18	Reserved	
...		
Bit 22	Reserved	
Bit 23	SSE	Emergency stop function
Bit 24	SD-Out1	Safe output
Bit 25	Reserved	
...		
Bit 31	Reserved	

Read access Write access Controller inhibit PLC-STOP No transfer

C15200	OMS: Stop function	UNSIGNED_8	9375 _d = 249F _h
---------------	---------------------------	------------	---------------------------------------

Selection of the stop function in special operation

Selection list (Lenze setting bold)		Information
0	STO	Safe torque off
1	SS1	Safe stop 1
2	SS2	Safe stop 2

Read access Write access Controller inhibit PLC-STOP No transfer

C15201	OMS: motion function	UNSIGNED_8	9374 _d = 249E _h
---------------	-----------------------------	------------	---------------------------------------

Selection of the motion function in special operation

Selection list (Lenze setting bold)		Info
3	SLS1	Safely limited speed 1 (Lenze setting up to SM301 V1.3)
4	SLS2	Safely limited speed 2 (From SM301 V1.1)
5	SLS3	Safely limited speed 3 (From SM301 V1.1)
6	SLS4	Safely limited speed 4 (as of SM301 V1.1)
11	Free traversing	(Lenze setting from SM301 V1.4)

Read access Write access Controller inhibit PLC-STOP No transfer

Parameter: C15202	Name: OMS: Function at LOW level	Data type: UNSIGNED_8	Index: 9373 _d = 249D _h
Function that is executed in case of LOW level at the safe input with OMS function. Caution: According to the closed-circuit principle, the parameterisation must not cause any additional danger.			
Selection list (read only)		Information	
0 Normal operation		(From SM301 V1.3)	
1 Special operation			
<input checked="" type="checkbox"/> Read access <input type="checkbox"/> Write access <input type="checkbox"/> Controller inhibit <input type="checkbox"/> PLC-STOP <input type="checkbox"/> No transfer			
Parameter: C15203	Name: SLI: Safely lim. increment	Data type: UNSIGNED_32	Index: 9372 _d = 249C _h
Number of increments for safely limited increment			
Setting range (min. value unit max. value)		Information	
0	Incr.	2147483647	Lenze: 1, deactivate: 0 (From SM301 V1.4)
<input checked="" type="checkbox"/> Read access <input type="checkbox"/> Write access <input type="checkbox"/> Controller inhibit <input type="checkbox"/> PLC-STOP <input type="checkbox"/> No transfer			
Parameter: C15204	Name: SLI: Amount of position change	Data type: UNSIGNED_32	Index: 9371 _d = 249B _h
Maximum position change while SLI is active.			
Display area (min. value unit max. value)		Information	
0	Incr.	2147483647	(From SM301 V1.4)
<input checked="" type="checkbox"/> Read access <input type="checkbox"/> Write access <input type="checkbox"/> Controller inhibit <input type="checkbox"/> PLC-STOP <input type="checkbox"/> No transfer			
Parameter: C15205	Name: SSE: Safe stop emergency function	Data type: UNSIGNED_8	Index: 9370 _d = 249A _h
Selection of the stop function for emergency stop			
Selection list (Lenze setting printed in bold)		Information	
0 STO		Safe torque off	
1 SS1		Safe stop 1	
<input checked="" type="checkbox"/> Read access <input type="checkbox"/> Write access <input type="checkbox"/> Controller inhibit <input type="checkbox"/> PLC-STOP <input type="checkbox"/> No transfer			
Parameter: C15300	Name: Restart behaviour	Data type: UNSIGNED_8	Index: 9275 _d = 243B _h
Behaviour for restart after functions have been cancelled			
Selection list (Lenze setting bold)		Information	
0 Acknowledged restart			
1 Automatic restart			
Subcodes		Information	
C15300/1		Restart - STO, SS1	
C15300/2		Restart - SS2, SOS	
<input checked="" type="checkbox"/> Read access <input type="checkbox"/> Write access <input type="checkbox"/> Controller inhibit <input type="checkbox"/> PLC-STOP <input type="checkbox"/> No transfer			
Parameter: C15305	Name: SS1, SS2: Stopping time	Data type: UNSIGNED_16	Index: 9270 _d = 2436 _h
Stopping time for the SS1 and SS2 safety functions			
Setting range (min. value unit max. value)		Information	
0	MS	30000	Lenze: 0, increment: 2 ms
<input checked="" type="checkbox"/> Read access <input type="checkbox"/> Write access <input type="checkbox"/> Controller inhibit <input type="checkbox"/> PLC-STOP <input type="checkbox"/> No transfer			
Parameter: C15306	Name: SS1 mode	Data type: UNSIGNED_8	Index: 9269 _d = 2435 _h
Selection list (Lenze setting bold)		Information	
0 STO after stopping time		(From SM301 V1.3)	
1 STO at n = 0			
<input checked="" type="checkbox"/> Read access <input type="checkbox"/> Write access <input type="checkbox"/> Controller inhibit <input type="checkbox"/> PLC-STOP <input type="checkbox"/> No transfer			
Parameter: C15307	Name: SS1: Deceleration STO after n=0	Data type: UNSIGNED_16	Index: 9268 _d = 2434 _h
Display area (min. value unit max. value)		Information	
0	ms	30000	Lenze: 0, increment: 2 ms (From SM301 V1.3)
<input checked="" type="checkbox"/> Read access <input type="checkbox"/> Write access <input type="checkbox"/> Controller inhibit <input type="checkbox"/> PLC-STOP <input type="checkbox"/> No transfer			

Parameter: C15308	Name: SS2 mode	Data type: UNSIGNED_8	Index: 9267 _d = 2433 _h
Selection whether SS2 is to be executed already after reaching n=0 SOS or only after reaching the parameterised stopping time.			
Selection list (Lenze setting bold)		Information	
0 SOS after stopping time		(As of SM301 V1.3)	
1 SOS at n = 0			
<input checked="" type="checkbox"/> Read access <input checked="" type="checkbox"/> Write access <input type="checkbox"/> Controller inhibit <input type="checkbox"/> PLC-STOP <input type="checkbox"/> No transfer			
Parameter: C15310	Name: Tolerance window (n=0)	Data type: INTEGER_16	Index: 9265 _d = 2431 _h
Safely monitored tolerance window for zero speed			
Setting range (min. value unit max. value)		Information	
0	rpm	16000	Lenze: 0
<input checked="" type="checkbox"/> Read access <input checked="" type="checkbox"/> Write access <input type="checkbox"/> Controller inhibit <input type="checkbox"/> PLC-STOP <input type="checkbox"/> No transfer			
Parameter: C15311	Name: SOS: Tolerance window (Delta p=0)	Data type: UNSIGNED_32	Index: 9264 _d = 2430 _h
Safely monitored tolerance window for zero position change			
Display area (min. value unit max. value)		Information	
0	Incr.	327680	Lenze: 0 (From SM301 V1.3)
<input checked="" type="checkbox"/> Read access <input checked="" type="checkbox"/> Write access <input type="checkbox"/> Controller inhibit <input type="checkbox"/> PLC-STOP <input type="checkbox"/> No transfer			
Parameter: C15312	Name: SOS: Maximum change in position	Data type: UNSIGNED_32	Index: 9263 _d = 242F _h
Amount of the maximum change in position while SOS was active			
Display area (min. value unit max. value)		Information	
0	Incr.	2147483647	(From SM301 V1.3)
<input checked="" type="checkbox"/> Read access <input type="checkbox"/> Write access <input type="checkbox"/> Controller inhibit <input type="checkbox"/> PLC-STOP <input type="checkbox"/> No transfer			
Parameter: C15315	Name: SS1, SS2: ramp monitoring	Data type: UNSIGNED_8	Index: 9260 _d = 242C _h
Selection whether the brake ramp is to be monitored when SS1 and SS2 are executed.			
Selection list (Lenze setting bold)		Information	
0 No ramp monitoring		(From SM301 V1.4)	
1 Ramp monitoring is activated			
<input checked="" type="checkbox"/> Read access <input checked="" type="checkbox"/> Write access <input type="checkbox"/> Controller inhibit <input type="checkbox"/> PLC-STOP <input type="checkbox"/> No transfer			
Parameter: C15316	Name: SS1, SS2: S-ramp time	Data type: UNSIGNED_8	Index: 9259 _d = 242B _h
S-ramp time of deceleration ramp for SS1 and SS2 if a linear ramp is not used.			
Setting range (min. value unit max. value)		Information	
0	%	100	0 (From SM301 V1.4)
<input checked="" type="checkbox"/> Read access <input checked="" type="checkbox"/> Write access <input type="checkbox"/> Controller inhibit <input type="checkbox"/> PLC-STOP <input type="checkbox"/> No transfer			
Parameter: C15317	Name: SS1, SS2: Start offset ramp	Data type: UNSIGNED_8	Index: 9258 _d = 242A _h
Speed offset at the start of the ramp monitoring.			
Display area (min. value unit max. value)		Information	
0	%	30	0 (From SM301 V1.4)
<input checked="" type="checkbox"/> Read access <input checked="" type="checkbox"/> Write access <input type="checkbox"/> Controller inhibit <input type="checkbox"/> PLC-STOP <input type="checkbox"/> No transfer			
Parameter: C15320	Name: SMS: Max. speed Nmax	Data type: INTEGER_16	Index: 9255 _d = 2427 _h
Selection of the maximum speed and activation of the SMS function			
Setting range (min. value unit max. value)		Information	
0	rpm	16000	Lenze: 1, deactivate: 0
<input checked="" type="checkbox"/> Read access <input checked="" type="checkbox"/> Write access <input type="checkbox"/> Controller inhibit <input type="checkbox"/> PLC-STOP <input type="checkbox"/> No transfer			

Parameter:	Name:	Data type:	Index:
C15321	SMS: Response (n>Nmax)	UNSIGNED_8	9254 _d = 2426 _h
Response to the exceeding of the set maximum speed			
Selection list (Lenze setting bold)		Information	
0	STO	Safe torque off	
1	SS1	Safe stop 1	
2	SS2	Safe stop 2	
<input checked="" type="checkbox"/> Read access <input type="checkbox"/> Write access <input type="checkbox"/> Controller inhibit <input type="checkbox"/> PLC-STOP <input type="checkbox"/> No transfer			
Parameter:	Name:	Data type:	Index:
C15330	SLS: Limited speed Nlim	UNSIGNED_16	9245 _d = 241D _h
Setting of the limited speed			
Setting range (min. value unit max. value)		Information	
0	rpm	16000	Lenze: 0
Subcodes		Information	
C15330/1		SLS1: Limited speed Nlim1	
C15330/2		SLS2: Limited speed Nlim2 (As of SM301 V1.1)	
C15330/3		SLS3: Limited speed Nlim3 (As of SM301 V1.1)	
C15330/4		SLS4: Limited speed Nlim4 (As of SM301 V1.1)	
<input checked="" type="checkbox"/> Read access <input type="checkbox"/> Write access <input type="checkbox"/> Controller inhibit <input type="checkbox"/> PLC-STOP <input type="checkbox"/> No transfer			
Parameter:	Name:	Data type:	Index:
C15331	SLS: Braking time Nlim	UNSIGNED_16	9244 _d = 241C _h
Safely monitored time for braking the drive to the limited speed set in C15330.			
Setting range (min. value unit max. value)		Information	
0	MS	30000	Lenze: 0, increment: 2 ms
Subcodes		Information	
C15331/1		SLS1: Braking time Nlim1	
C15331/2		SLS2: Braking time Nlim2 (as of SM301 V1.1)	
C15331/3		SLS3: Braking time Nlim3 (as of SM301 V1.1)	
C15331/4		SLS4: Braking time Nlim4 (as of SM301 V1.1)	
<input checked="" type="checkbox"/> Read access <input type="checkbox"/> Write access <input type="checkbox"/> Controller inhibit <input type="checkbox"/> PLC-STOP <input type="checkbox"/> No transfer			
Parameter:	Name:	Data type:	Index:
C15332	SLS: Response (n>Nlim)	UNSIGNED_8	9243 _d = 241B _h
Response in the safety module to the exceeding of the limited speed			
Selection list (Lenze setting bold)		Information	
0	STO	Safe torque off	
1	SS1	Safe stop 1	
2	SS2	Safe stop 2	
Subcodes		Information	
C15332/1		SLS1: Response (n>Nlim1)	
C15332/2		SLS2: Response (n>Nlim2) (as of SM301 V1.1)	
C15332/3		SLS3: Response (n>Nlim3) (as of SM301 V1.1)	
C15332/4		SLS4: Response (n>Nlim4) (as of SM301 V1.1)	
<input checked="" type="checkbox"/> Read access <input type="checkbox"/> Write access <input type="checkbox"/> Controller inhibit <input type="checkbox"/> PLC-STOP <input type="checkbox"/> No transfer			

Parameter:	Name:	Data type:	Index:
C15333	SLS: Permissible direction of movement	UNSIGNED_8	9242 _d = 241A _h
Permissible direction of movement during SLS monitoring			
Selection list (Lenze setting printed in bold)		Information	
0	Both directions enabled		
1	Positive direction enabled		
2	Negative direction enabled		
Subcodes		Information	
C15333/1		SLS1: Permissible direction of movement (from SM301 V1.3)	
C15333/2		SLS2: Permissible direction of movement (from SM301 V1.3)	
C15333/3		SLS3: Permissible direction of movement (from SM301 V1.3)	
C15333/4		SLS4: Permissible direction of movement (from SM301 V1.3)	
<input checked="" type="checkbox"/> Read access <input type="checkbox"/> Write access <input type="checkbox"/> Controller inhibit <input type="checkbox"/> PLC-STOP <input type="checkbox"/> No transfer			
C15340	SDI: Monitoring - normal operation	UNSIGNED_8	9235 _d = 2413 _h
Setting of the monitoring of the direction of movement of the motor during normal operation			
Selection list (read only)		Information	
0	Both directions enabled	(From SM301 V1.3)	
1	Positive direction enabled		
2	Negative direction enabled		
<input checked="" type="checkbox"/> Read access <input type="checkbox"/> Write access <input type="checkbox"/> Controller inhibit <input type="checkbox"/> PLC-STOP <input type="checkbox"/> No transfer			
C15341	SDI: Deceleration time	UNSIGNED_16	9234 _d = 2412 _h
Safely monitored time from activation to switching on the monitoring SDIpos/SDIneg			
Display area (min. value unit max. value)		Information	
0	ms	30000	(From SM301 V1.3)
<input checked="" type="checkbox"/> Read access <input type="checkbox"/> Write access <input type="checkbox"/> Controller inhibit <input type="checkbox"/> PLC-STOP <input type="checkbox"/> No transfer			
C15342	SDI: Tolerance threshold	UNSIGNED_32	9233 _d = 2411 _h
Setting of the tolerance threshold by how many increments the motor may move towards the direction inhibited through SDI			
Display area (min. value unit max. value)		Information	
0	Incr.	327680	(From SM301 V1.3)
<input checked="" type="checkbox"/> Read access <input type="checkbox"/> Write access <input type="checkbox"/> Controller inhibit <input type="checkbox"/> PLC-STOP <input type="checkbox"/> No transfer			
C15343	SDI: Error response	UNSIGNED_8	9232 _d = 2410 _h
Response to a violation of the permitted direction of movement of the motor			
Selection list (read only)		Information	
0	STO	(From SM301 V1.3)	
1	SS1		
2	SS2		
<input checked="" type="checkbox"/> Read access <input type="checkbox"/> Write access <input type="checkbox"/> Controller inhibit <input type="checkbox"/> PLC-STOP <input type="checkbox"/> No transfer			
C15344	SDI: Maximum change in position	UNSIGNED_32	9231 _d = 240F _h
Maximum change in position in inhibited direction if SDI is active			
Display area (min. value unit max. value)		Information	
0	Incr.	2147483647	
Subcodes		Information	
C15344/1		SDIpos: Maximum change in position (from SM301 V1.3)	
C15344/2		SDIneg: Maximum change in position (from SM301 V1.3)	
<input checked="" type="checkbox"/> Read access <input type="checkbox"/> Write access <input type="checkbox"/> Controller inhibit <input type="checkbox"/> PLC-STOP <input type="checkbox"/> No transfer			

Parameter:	Name:	Data type:	Index:
C15350	SLS, SMS: Max. response time	UNSIGNED_16	9225 _d = 2409 _h
Maximum time after an exceeded speed has been detected, after which the speed must be below the limit again.			
Setting range (min. value unit max. value)		Information	
0	MS	30000	Lenze: 0, increment: 2 ms
<input checked="" type="checkbox"/> Read access <input type="checkbox"/> Write access <input type="checkbox"/> Controller inhibit <input type="checkbox"/> PLC-STOP <input type="checkbox"/> No transfer			
Parameter:	Name:	Data type:	Index:
C15400	Motor encoder system	UNSIGNED_8	9175 _d = 23D7 _h
Selection of the encoder system connected			
Selection list (Lenze setting bold)		Information	
0	No encoder system		
1	Sin/cos encoder	"Sin/cos encoder" is used in place of the entries "Sin/cos encoder", "Absolute value encoder (Hiperface)" and "Absolute value encoder (EnDat)" of code C00422 of the standard device 9400.	
2	Resolver		
<input checked="" type="checkbox"/> Read access <input type="checkbox"/> Write access <input type="checkbox"/> Controller inhibit <input type="checkbox"/> PLC-STOP <input type="checkbox"/> No transfer			
Parameter:	Name:	Data type:	Index:
C15401	Motor encoder status	UNSIGNED_8	9174 _d = 23D6 _h
Status of the encoder evaluation			
Selection list (read only)		Information	
0	Valid	Encoder data is valid	
1	Fault	Encoder data is invalid	
<input checked="" type="checkbox"/> Read access <input type="checkbox"/> Write access <input type="checkbox"/> Controller inhibit <input type="checkbox"/> PLC-STOP <input type="checkbox"/> No transfer			
Parameter:	Name:	Data type:	Index:
C15402	Actual speed value n_safe	INTEGER_16	9173 _d = 23D5 _h
Display of the current speed calculated from the safety module			
Display area (min. value unit max. value)		Information	
-16000	rpm	16000	With invalid encoder data (C15401 = 1) 32767 is displayed.
<input checked="" type="checkbox"/> Read access <input type="checkbox"/> Write access <input type="checkbox"/> Controller inhibit <input type="checkbox"/> PLC-STOP <input type="checkbox"/> No transfer			
Parameter:	Name:	Data type:	Index:
C15405	Internal actual speed value	INTEGER_16	9170 _d = 23D2 _h
Internal actual speed values of SM301.			
Display area (min. value unit max. value)		Information	
-16000	rpm	16000	(As of SM301 V1.4) With invalid encoder data (C15401 = 1) 32767 is displayed.
Subcodes		Information	
C15405/1	-	Internal actual speed value nSM detected from motor position.	
C15405/2	-	Internal actual speed value nCG detected from position data of the standard device.	
<input checked="" type="checkbox"/> Read access <input type="checkbox"/> Write access <input type="checkbox"/> Controller inhibit <input type="checkbox"/> PLC-STOP <input type="checkbox"/> No transfer			
Parameter:	Name:	Data type:	Index:
C15409	Motor mounting direction	UNSIGNED_8	9166 _d = 23CE _h
Setting of the motor mounting direction.			
Selection list (Lenze setting bold)		Information	
0	Motor rotating clockwise	(From SM301 V1.4)	
1	Motor rotating counter-clockwise		
<input checked="" type="checkbox"/> Read access <input type="checkbox"/> Write access <input type="checkbox"/> Controller inhibit <input type="checkbox"/> PLC-STOP <input type="checkbox"/> No transfer			

Parameter:	Name:	Data type:	Index:
C15410	Response time of encoder monitoring	UNSIGNED_8	9165 _d = 23CD _h
Max. internal time after which encoder errors lead to a system response			
Selection list		Information	
0	12 ms	(As of SM301 V1.2)	
10	50 ms	(From SM301 V1.4: Resolver is sole encoder → 50 or 100 ms)	
20	100 ms		
<input checked="" type="checkbox"/> Read access <input type="checkbox"/> Write access <input type="checkbox"/> Controller inhibit <input type="checkbox"/> PLC-STOP <input type="checkbox"/> No transfer			
Parameter:	Name:	Data type:	Index:
C15411	Tolerance of speed comparison	UNSIGNED_16	9164 _d = 23CC _h
Tolerance of the speed comparison in the safety module			
Display area (min. value unit max. value)		Information	
0	rpm	16000	(From SM301 V1.3)
<input checked="" type="checkbox"/> Read access <input type="checkbox"/> Write access <input type="checkbox"/> Controller inhibit <input type="checkbox"/> PLC-STOP <input type="checkbox"/> No transfer			
Parameter:	Name:	Data type:	Index:
C15420	Number of increments - sin/cos encoder	UNSIGNED_16	9155 _d = 23C3 _h
Number of increments of the sin/cos encoder used			
Setting range (min. value unit max. value)		Information	
1		16384	Lenze: 1
<input checked="" type="checkbox"/> Read access <input type="checkbox"/> Write access <input type="checkbox"/> Controller inhibit <input type="checkbox"/> PLC-STOP <input type="checkbox"/> No transfer			
Parameter:	Name:	Data type:	Index:
C15430	Number of pole pairs of resolver	UNSIGNED_8	9145 _d = 23B9 _h
Number of pole pairs of the used resolver			
Setting range (min. value unit max. value)		Information	
1		10	Lenze: 1 (From SM301 V1.3)
<input checked="" type="checkbox"/> Read access <input type="checkbox"/> Write access <input type="checkbox"/> Controller inhibit <input type="checkbox"/> PLC-STOP <input type="checkbox"/> No transfer			
Parameter:	Name:	Data type:	Index:
C15500	Position encoder system	UNSIGNED_8	9075 _d = 2373 _h
Setting of the connected position encoder system			
Selection list (read only)		Information	
0	No position encoder	(From SM301 V1.3)	
1	Analog encoder (Sin-Cos/TTL)		
2	Digital encoder (SSI/BUS)		
<input checked="" type="checkbox"/> Read access <input type="checkbox"/> Write access <input type="checkbox"/> Controller inhibit <input type="checkbox"/> PLC-STOP <input type="checkbox"/> No transfer			
Parameter:	Name:	Data type:	Index:
C15501	Position encoder - gearbox factor	UNSIGNED_16	9074 _d = 2372 _h
Setting of the gearbox factor between motor and position encoder			
Display area (min. value unit max. value)		Information	
20	%	50000	Lenze: 100 (From SM301 V1.3) 100 ≙ i = 1.00 2543 ≙ i = 25.43
<input checked="" type="checkbox"/> Read access <input type="checkbox"/> Write access <input type="checkbox"/> Controller inhibit <input type="checkbox"/> PLC-STOP <input type="checkbox"/> No transfer			
Parameter:	Name:	Data type:	Index:
C15502	Position encoder - mounting direction	UNSIGNED_8	9073 _d = 2371 _h
Setting of the mounting direction of the position encoder regarding the motor encoder			
Selection list (read only)		Information	
0	Like motor encoder	(From SM301 V1.3)	
1	Inverted to the motor encoder	If the mounting directions of the motor (C02527/0) and position encoder (C02529/0) in the standard device are set in different directions of rotation, this parameter must be set to "inverted to the motor encoder".	
<input checked="" type="checkbox"/> Read access <input type="checkbox"/> Write access <input type="checkbox"/> Controller inhibit <input type="checkbox"/> PLC-STOP <input type="checkbox"/> No transfer			

Parameter: C15800	Name: Current error type	Data type: UNSIGNED_8	Index: 8775 _d = 2247 _h
Type of the currently pending error			
Selection list (read only)		Information	
0	No error		
1	Warning		
2	Trouble		
<input checked="" type="checkbox"/> Read access <input type="checkbox"/> Write access <input type="checkbox"/> Controller inhibit <input type="checkbox"/> PLC-STOP <input type="checkbox"/> No transfer			
C15801	Error history	UNSIGNED_16	8774 _d = 2246 _h
for Lenze service			
Selection list (read only)		Information	
-	-	-	(As of SM301 V1.2)
Subcodes		Information	
C15801/1	-	Error history 1	
...			
C15801/8	-	Error history 8	
<input checked="" type="checkbox"/> Read access <input type="checkbox"/> Write access <input type="checkbox"/> Controller inhibit <input type="checkbox"/> PLC-STOP <input type="checkbox"/> No transfer			
C15805	Service code	UNSIGNED_32	8770 _d = 2242 _h
for Lenze service			
Selection list (read only)		Information	
-	-	-	(From SM301 V1.2)
Subcodes		Information	
C15805/1	-	-	
C15805/2	-	-	
C15805/3	-	-	
<input checked="" type="checkbox"/> Read access <input type="checkbox"/> Write access <input type="checkbox"/> Controller inhibit <input type="checkbox"/> PLC-STOP <input type="checkbox"/> No transfer			
C15810	Service code	UNSIGNED_32	8765 _d = 223D _h
for Lenze service			
Selection list (read only)		Information	
-	-	-	(From SM301 V1.2)
Subcodes		Information	
C15810/1	-	-	
...			
C15810/11	-	-	
<input checked="" type="checkbox"/> Read access <input type="checkbox"/> Write access <input type="checkbox"/> Controller inhibit <input type="checkbox"/> PLC-STOP <input type="checkbox"/> No transfer			
C15815	Service code	UNSIGNED_16	8760 _d = 2238 _h
for Lenze service			
Selection list (read only)		Information	
-	-	-	(From SM301 V1.3)
<input checked="" type="checkbox"/> Read access <input type="checkbox"/> Write access <input type="checkbox"/> Controller inhibit <input type="checkbox"/> PLC-STOP <input type="checkbox"/> No transfer			
C15820	Internal actual position value	INTEGER_32	8755 _d = 2233 _h
for Lenze service			
Selection list (read only)		Information	
-	-	-	(From SM301 V1.3)
Subcodes		Information	
C15820/1	-	Internal actual position value pSM	
C15820/2	-	Internal actual position value pGG	
<input checked="" type="checkbox"/> Read access <input type="checkbox"/> Write access <input type="checkbox"/> Controller inhibit <input type="checkbox"/> PLC-STOP <input type="checkbox"/> No transfer			

Parameter: C15821	Name: Service code	Data type: INTEGER_16	Index: 8754 _d = 2232 _h
for Lenze service: Currently monitored speed value of ramp monitoring.			
Display area (min. value unit max. value)		Information	
-16000	rpm	16000	Displayed value is only valid if SS1 or SS2 are active with ramp monitoring. (From SM301 V1.4)
<input checked="" type="checkbox"/> Read access <input type="checkbox"/> Write access <input type="checkbox"/> Controller inhibit <input type="checkbox"/> PLC-STOP <input type="checkbox"/> No transfer			
Parameter: C15822	Name: Service code	Data type: INTEGER_16	Index: 8753 _d = 2231 _h
for Lenze service: Minimum differences between actual speed value and monitored ramp.			
Display area (min. value unit max. value)		Information	
-16000	rpm	16000	The value is kept until the ramp monitoring is restarted. (From SM301 V1.4)
<input checked="" type="checkbox"/> Read access <input type="checkbox"/> Write access <input type="checkbox"/> Controller inhibit <input type="checkbox"/> PLC-STOP <input type="checkbox"/> No transfer			
Parameter: C15890	Name: Current time	Data type: UNSIGNED_32	Index: 8685 _d = 21ED _h
Relative time for use in logbook.			
Display area (min. value unit max. value)		Information	
0	ms	4294967295	(From SM301 V1.4)
<input checked="" type="checkbox"/> Read access <input type="checkbox"/> Write access <input type="checkbox"/> Controller inhibit <input type="checkbox"/> PLC-STOP <input type="checkbox"/> No transfer			
Parameter: C15891	Name: Log function	Data type: UNSIGNED_8	Index: 8684 _d = 21EC _h
Setting of the logging behaviour (trigger condition). (From SM301 V1.4)			
Selection list		Information	
0	Logging is active	Logging is always active.	
1	Logging is stopped	Logging is switched off.	
2	Stop logging in case of error	Logging is stopped if an error occurs.	
3	Stop logging in case of STO	Logging is stopped if STO occurs.	
4	Stop logging in case of SS1	Logging is stopped if SS1 occurs.	
5	Stop logging in case of SS2	Logging is stopped if SS2 occurs.	
<input checked="" type="checkbox"/> Read access <input checked="" type="checkbox"/> Write access <input type="checkbox"/> Controller inhibit <input type="checkbox"/> PLC-STOP <input type="checkbox"/> No transfer			
Parameter: C15892	Name: Log time	Data type: UNSIGNED_32	Index: 8683 _d = 21EB _h
Time of log entry.			
Display area (min. value unit max. value)		Information	
0	ms	4294967295	(From SM301 V1.4)
Subcodes		Information	
C15892/1		Log time n	
C15892/2		Log time n-1	
...			
C15892/10		Log time n-9	
<input checked="" type="checkbox"/> Read access <input type="checkbox"/> Write access <input type="checkbox"/> Controller inhibit <input type="checkbox"/> PLC-STOP <input type="checkbox"/> No transfer			
Parameter: C15893	Name: Log state	Data type: BITFIELD_64	Index: 8682 _d = 21EA _h
Logged state			
Display area		Information	
-	-	-	(From SM301 V1.4)
Value is bit-coded		Information	
Bit 0	STO via SD-In	STO was triggered via a safe input.	
Bit 1	STO via S-bus	STO was triggered via the safety bus.	
Bit 2	STO through error	STO was triggered through an error.	
Bit 3	Reserved	-	

Parameter:	Name:	Data type:	Index:
C15893	Log state	BITFIELD_64	8682 _d = 21EA _h
Bit 4	SS1 via SD-In		SS1 was triggered via a safe input.
Bit 5	SS1 via S-bus		SS1 was triggered via the safety bus.
Bit 6	SS1 through error		SS1 was triggered through an error.
Bit 7	Reserved		-
Bit 8	SS2 via SD-In		SS2 was triggered via a safe input.
Bit 9	SS2 via S-bus		SS2 was triggered via the safety bus.
Bit 10	SS2 through error		SS2 was triggered through an error.
Bit 11	Reserved		-
Bit 12	SLS1 via SD-In		SLS1 was triggered via a safe input.
Bit 13	SLS1 via S-bus		SLS1 was triggered via the safety bus.
Bit 14	SLS1 via OMS		SLS1 was triggered via the operating mode changeover.
Bit 15	Reserved		-
Bit 16	SLS2 via SD-In		SLS2 was triggered via a safe input.
Bit 17	SLS2 via S-bus		SLS2 was triggered via the safety bus.
Bit 18	SLS2 via OMS		SLS2 was triggered via the operating mode changeover.
Bit 19	Reserved		-
Bit 20	SLS3 via SD-In		SLS3 was triggered via a safe input.
Bit 21	SLS3 via S-bus		SLS3 was triggered via the safety bus.
Bit 22	SLS3 via OMS		SLS3 was triggered via the operating mode changeover.
Bit 23	Reserved		-
Bit 24	SLS4 via SD-In		SLS4 was triggered via a safe input.
Bit 25	SLS4 via S-bus		SLS4 was triggered via the safety bus.
Bit 26	SLS4 via OMS		SLS5 was triggered via the operating mode changeover.
Bit 27	Reserved		-
Bit 28	SDIpos via SD-In		SDIpos was triggered via a safe input.
Bit 29	SDIpos via S-bus		SDIpos was triggered via the safety bus.
Bit 30	SDIpos via SLS		SDIpos was triggered in combination with SLS.
Bit 31	SDIpos in normal operation		SDIpos was triggered in normal operation.
Bit 32	SDIneg via SD-In		SDIneg was triggered via a safe input.
Bit 33	SDIneg via S-bus		SDIneg was triggered via the safety bus.
Bit 34	SDIneg via SLS		SDIneg was triggered in combination with SLS.
Bit 35	SDIneg in normal operation		SDIneg was triggered in normal operation.
Bit 36	SLI is active		SLI was triggered in special operation.
Bit 37	Reserved		-
Bit 38	Reserved		-
Bit 39	Reserved		-
Bit 40	Special operation via SD-In		Special operation was triggered via a safe input.
Bit 41	Special operation via S-bus		Special operation was triggered via the safety bus.
Bit 42	Reserved		-
Bit 43	Reserved		-
Bit 44	ES via SD-In		ES was triggered via a safe input.
Bit 45	ES via S-bus		ES was triggered via the safety bus.
Bit 46	Reserved		-
Bit 47	Reserved		-

Parameter:	Name:	Data type:	Index:
C15893	Log state	BITFIELD_64	8682 _d = 21EA _h
Bit 48	FailSafeValues via control word	Safe replacement values on the safety bus were activated via the control word.	
Bit 49	FailSafeValues through error	Safe replacement values on the safety bus were activated through an error.	
Bit 50	Reserved	-	
Bit 51	Reserved	-	
Bit 52	SD-In1 active	The safe input SD-In1 has been switched on.	
Bit 53	SD-In2 active	The safe input SD-In2 has been switched on.	
Bit 54	SD-In3 active	The safe input SD-In3 has been switched on.	
Bit 55	SD-In4 active	The safe input SD-In4 has been switched on.	
Bit 56	Reserved	-	
...			
Bit 63	Reserved	-	
Subcodes	Information		
C15893/1	Log state n		
C15893/2	Log state n-1		
...			
C15893/10	Log state n-9		
<input checked="" type="checkbox"/> Read access <input type="checkbox"/> Write access <input type="checkbox"/> Controller inhibit <input type="checkbox"/> PLC-STOP <input type="checkbox"/> No transfer			
C15900	Firmware - product type	VISIBLE_STRING	8675 _d = 21E3 _h
Display of the product type (E94FAFE)			
<input checked="" type="checkbox"/> Read access <input type="checkbox"/> Write access <input type="checkbox"/> Controller inhibit <input type="checkbox"/> PLC-STOP <input type="checkbox"/> No transfer			
C15901	Firmware - compilation date	VISIBLE_STRING	8674 _d = 21E2 _h
Display of the compilation date			
<input checked="" type="checkbox"/> Read access <input type="checkbox"/> Write access <input type="checkbox"/> Controller inhibit <input type="checkbox"/> PLC-STOP <input type="checkbox"/> No transfer			
C15902	Firmware version	VISIBLE_STRING	8673 _d = 21E1 _h
Software version of the firmware, e.g.: "V1.0"			
<input checked="" type="checkbox"/> Read access <input type="checkbox"/> Write access <input type="checkbox"/> Controller inhibit <input type="checkbox"/> PLC-STOP <input type="checkbox"/> No transfer			

1 Safety engineering

Appendix

Module error messages

1.10.2 Module error messages

The Parameterisation & Configuration Software Manual provides information on diagnostics & fault analysis and describes the structure of the operating system's error messages in the logbook.

Entries

Field		Description	Error type/response/ Note
Error number			
Internal			
1	0x01	Internal error, STO is active	Replace safety module. Consultation with Lenze is required.
2	0x02	Internal error, SS1 is active	
3	0x03	Internal error, SS2 is active	
Communication - standard device			
16	0x10	Communication error - standard device (communication between standard device and SM301 cancelled)	Warning/STO
17	0x11	Synchronisation error - standard device	No error status Logbook entry/info
PROFIsafe			
33	0x21	Safety address is invalid (0 or 0xFFFF)	
34	0x22	PROFIsafe communication error	
35	0x23	F_WD_Time exceeded (PROFIsafe monitoring time activated)	PROFIsafe passivated/- No error status No diagnostic telegram via PROFIBUS
36	0x24	PROFIsafe deactivated	
37	0x25	PROFIsafe has quit Data Exchange	
38	0x26	PROFIsafe invalid data	
39	0x27	Error - F parameter (Wrong parameter setting of the F PLC)	PROFIsafe parameter setting/STO No error status
40	0x28	Communication error in parameter phase	
Inputs			
49	0x31	Error - discrepancy or functional test SD-In1	Trouble/- OFF state for the affected input
50	0x32	Error - discrepancy or functional test SD-In2	
51	0x33	Error - discrepancy or functional test SD-In3	
52	0x34	Error - discrepancy or functional test SD-In4	
53	0x35	Internal error AIS	
54	0x36	Internal error AIE	
55	0x37	Internal error - module switch	
57	0x39	Deactivated SD-In1 = high (Initialisation error, input in ON state)	Trouble/STO
58	0x3A	Deactivated SD-In2 = high	
59	0x3B	Deactivated SD-In3 = high	
60	0x3C	Deactivated SD-In4 = high	

Field	Description		Error type/response/ Note	
Error number				
PROFIsafe				
64	0x40	F_Dest_Add does not equal F address	PROFIsafe parameter setting/STO No error status	
65	0x41	F_Dest_Add = 0 or FFFFhex		
66	0x42	F_Source_Add = 0 or FFFFhex		
67	0x43	F_WD_Time is 0 msec		
68	0x44	F_SIL exceeds technical SIL		
69	0x45	F_CRC_Length error		
70	0x46	F parameter version incorrect		
71	0x47	PROFIsafe CRC1 error		
72	0x48	reserved (PROFIsafe standard)		-
73	0x49	reserved (PROFIsafe standard)		-
74	0x4A	reserved (PROFIsafe standard)	-	
Test functions				
81	0x51	Error SD-Inx/CLx (internal short circuit in one of the inputs)	Trouble/- OFF state for all SD-In	
82	0x52	Error SD-Inx/CLx (internal short circuit in one of the inputs)		
89	0x59	Short circuit SD-Out		
93	0x5D	Error - internal disconnecting path (internal error of the safe switch-off logic)	Trouble/STO OFF state for all SD-In and SD-Out	
94	0x5E	Test pulse error - internal switch-off path (internal error of the safe switch-off logic)	Trouble/STO	

Field	Description		Error type/response/ Note
Error number			
Safety functions			
97	0x61	SS1/SS2: Stopping time exceeded (The drive has not reached zero speed within the stopping time.)	Warning/STO
98	0x62	SLS1: Nlim1 exceeded (The drive has exceeded the limited speed.)	Warning/response can be set
99	0x63	SLS2: Nlim2 exceeded (The drive has exceeded the limited speed.)	Warning/response can be set
100	0x64	SLS3: Nlim3 exceeded (The drive has exceeded the limited speed.)	Warning/response can be set
101	0x65	SLS4: Nlim4 exceeded (The drive has exceeded the limited speed.)	Warning/response can be set
102	0x66	SLS/SMS: Error stop not executed (The drive has exceeded the limited speed or maximum speed and has not stopped the drive safely. Following error to no. 0x62 or 0x69)	Warning/STO
103	0x67	SDIpos: Wrong direction of movement	Warning/response can be set
104	0x68	SDIneg: Wrong direction of movement	Warning/response can be set
105	0x69	SMS: Nmax exceeded (The drive has exceeded the monitored maximum speed.)	Warning/response can be set
106	0x6A	SOS: Tolerance limit exceeded (The drive has exceeded a tolerance limit.)	Warning/STO
107	0x6B	No encoder system parameterised (SMS, SLS1 or SS2 are tried to be executed without an encoder being parameterised.)	Warning/STO
108	0x6C	CAS: Circulation time exceeded Maximum time between release and feedback of the cascading function has been exceeded.	Warning/STO
109	0x6D	CAS: Hardware or discrepancy error The cascading output has not been switched off quickly enough by the hardware or there is a discrepancy at the cascading input.	Warning/STO
110	0x6E	SS1/SS2: Speed ramp exceeded Monitoring of the speed ramp is activated. When the stop function SS1/SS2 is executed, the deceleration of the speed ramp is monitored. When the monitoring limits are exceeded, an error is reported.	Warning/STO
111	0x6F	SLI: Safely limited increment exceeded The safely limited increment is monitored in the special operation mode. The parameterised increment has been exceeded.	Warning/STO
Test functions - output			
128	0x80	Stuck at High SD-Out1, channel A (Short circuit (High))	Trouble/- SD-Out1: OFF state
129	0x81	Stuck at Low SD-Out1, channel A (Short circuit (Low))	
130	0x82	Stuck at High SD-Out1, channel B	
131	0x83	Stuck at Low SD-Out1, channel B	

Field Error number	Description	Error type/response/ Note
Test functions - inputs		
144	0x90 Stuck at High SD-In1, channel A (Short circuit (High))	Trouble/- SD-In1: OFF state
145	0x91 Stuck at High SD-In1, channel B	
146	0x92 Stuck at High SD-In2, channel A	Trouble/- SD-In2: OFF state
147	0x93 Stuck at High SD-In2, channel B	
148	0x94 Stuck at High SD-In3, channel A	Trouble/- SD-In3: OFF state
149	0x95 Stuck at High SD-In3, channel B	
150	0x96 Stuck at High SD-In4, channel A	Trouble/- SD-In4: OFF state
151	0x97 Stuck at High SD-In4, channel B	
154	0x9A CLA/CLB short circuit Short circuit between the CLA and CLB clock outputs	Trouble/- SD-In: OFF state
Safe parameterisation		
160	0xA0 New parameter set deleted (by the safe parameter setting in the Engineer)	
161	0xA1 New safe parameter set loaded (by the safe parameter setting in the Engineer or the procedure with the module switch)	-/- Logbook entry: Info
162	0xA2 Memory module parameter set - access error (Error while accessing the parameter set of the memory module.)	
163	0xA3 Different parameter sets (in the memory module and SM301)	
164	0xA4 No safe parameter set in the safety module (SM301 has no parameter set.)	
165	0xA5 Defective parameter set (SM301 parameter set is defective.)	Trouble/STO OFF state for all SD-In and SD-Out
166	0xA6 Parameter set in memory module - format error (Format error in parameter set of memory module)	
167	0xA7 Parameter set - plausibility error	
168	0xA8 Parameter set - communication error (Communication error when loading the parameter set)	
169	0xA9 Module ID does not equal effective safety address (Module ID in the parameter set does not equal the effective safety address)	Warning/STO OFF state for all SD-In and SD-Out
Test functions - internal module		
192	0xC0 Reference voltage error	
193	0xC1 6 V voltage error	
194	0xC2 5 V voltage error	Trouble/STO OFF state for all SD-In and SD-Out
195	0xC3 2.6 V voltage error	
208	0xD0 Safe speed is invalid	Trouble/STO
209	0xD1 SSM: Encoder error	Trouble/STO
210	0xD2 SSM: Resolver error	Trouble/STO
211	0xD3 SSM: Standard device data error	
212	0xD4 SSM: Speed comparison error	Trouble/STO
213	0xD5 SSM: Synchronisation error	
214	0xD6 SSM: Wrong PDO version	Trouble/STO

Tab. 1-24 Description of the numerical entries

1.11 Total index

A

- Address code, 94
- Address switch, 94
- Application as directed, 8
- Application range, 16
- Application, as directed, 8
- Applications according to
 - EN ISO 13849-1, 5
 - IEC 61508, 5

B

- Braking time Nlim (C15331), 72 , 130
- Bus interfaces, 96

C

- CAS: Cascading (C15035), 87 , 122
- CAS: Stop delay (C15036), 87 , 122
- Cascading, 85
- Codes, Module internal, 117
- Command status (C15003), 119
- Compatibility, 19
- Compatibility , 19
- Control category, 5
- Current time (C15890), 110 , 135

D

- Definitions, terms, 6
- DIP switch, position display (C15101), 95 , 125
- Direction of movement, Safe ..., 74

E

- effective safety address (C15112), 95 , 108 , 125
- Emergency stop, 67
- Error, current error type (C15800), 134
- Error history (C15801), 134
- Error states, 109

F

- Fail-safe status, 14
- Firmware
 - date (C15902), 137
 - product type (C15900), 137
 - version (C15902), 137

H

- Hazard analysis, 10

I

- Identification, 15
- Input image (C15040), 122
- Inputs, safe, 30
- Internal actual position value (C15810), 134
- Internal actual speed value (C15405), 46 , 132

L

- Legal regulations, 8
- Limited speed Nlim (C15330), 72 , 130
- Log function (C15890), 110 , 135
- Log state (C15893), 111 , 135
- Log time (C15892), 111 , 135
- Logbook function
 - in SM301, 110
 - in the controller, 110

M

Max. response time (C15350), 68 , 73 , 132
 Maximum speed Nmax (C15320), 68 , 129
 Module ID, 94
 Module internal codes, 117
 Motor encoder status (C15401), 46 , 132
 Motor encoder system (C15400), 46 , 132
 Motor mounting direction (C15409), 46 , 132
 Motor-encoder combinations, 18

N

Nameplate data, 15
 Number of increments - sin/cos encoder (C15420), 47 , 133
 Number of pole pairs of resolver (C15430), 47 , 133

O

Output, safe, 37
 Output image (C15060), 40 , 125

P

Parameter CRC (C15011), 119
 Parameter set status (C15010), 119
 Parameter set version (C15016), 120
 Parameter setting, safe, 106
 Password, length, reset, 106
 Performance Level, 5
 Position detection, 42
 Position encoder - mounting direction (C15502), 47 , 133
 Position encoder system (C15500), 47 , 133
 Priorisation, 48
 PROFIsafe connection, 96

R

Ramp monitoring SS1/SS2, 64
 Residual hazards, 9
 Response (n>Nlim) (C15332), 72 , 130
 Response (n>Nmax) (C15321), 68 , 130
 Response time of encoder monitoring (C15410), 46 , 133
 Response times, 112
 - output, 113
 Restart, 50

Restart behaviour (C15300), 50 , 54 , 58 , 63 , 128
 Risk analysis, 10

S

S-DIn discrepancy time (C15033), 32 , 121
 S-DIn free assignment (C15032), 31 , 121
 S-DIn input delay (C15034), 33 , 121
 S-DIn sensor function (C15031), 30 , 84 , 120
 S-DIn sensor type (C15030), 30 , 120
 S-DOut condition (C15051), 38 , 123
 S-DOut condition (C15052), 39 , 124
 Safe direction, 74
 Safe enable switch, 84
 Safe inputs, 30
 Safe maximum speed, 68
 Safe operation mode selector, 78
 Safe output, 37
 Safe parameter setting, 106
 Safe position detection, 42
 Safe speed measurement, 42
 Safe stop 1, 56
 Safe stop 2, 60
 Safe stop emergency function (C15205), 31 , 48 , 67 , 128
 Safe torque off, 54
 Safely limited speed, 71
 Safety, safety engineering, 3
 Safety address, 94
 Safety address (C15111), 95 , 125
 Safety bus
 - configuration (C15100), 96 , 125
 - control data display (C15115), 101 , 127
 - Filter control data (C15113), 100 , 126
 Safety category, 19
 Safety engineering, 3
 - safety functions, 48
 - with L-force | 9400, 5
 Safety functions, 5 , 48
 - safety instructions, during operation, 9
 Safety instructions, during operation, 9
 SDI: Deceleration time (C15341), 76 , 131
 SDI: Error response (C15343), 76 , 131
 SDI: Maximum change in position (C15344), 76 , 131
 SDI: Monitoring - normal operation (C15340), 76 , 131

SDI: Tolerance threshold (C15342), 76 , 131
Sensors, Overview ..., 11
Service code (C15805), 134
Service code (C15810), 134
Service code (C15821), 135
Service code (C15822), 135
SLI: Amount of position change (C15204), 82 , 128
SLI: Safely lim. increment (C15203), 82 , 128
SLS: Permissible direction of movement (C15333), 73 , 131
SOS: Maximum change in position (C15312), 63 , 129
Special operation
- motion function (C15201), 82 , 127
- stop function (C15200), 82 , 127
Speed
- Safe maximum ..., 68
- safely limited ..., 71
Speed measurement, Safe, 42
Speed n_safe (C15402), 46 , 132
Speed window (n=0) (C15310), 58 , 63 , 65 , 129
speed window (n=0) (C15310), 63 , 129
SS1, SS2: Ramp monitoring (C15315), 65 , 129
SS1, SS2: S-ramp time (C15316), 66 , 129
SS1, SS2: Start offset ramp (C15317), 66 , 129
SS1: Deceleration STO after n=0 (15307), 58 , 128
SS2 mode (C15308), 63 , 129
Stop 1
- ramp monitoring, 64
- safe ..., 56
Stop 2
- ramp monitoring, 64
- safe ..., 60
Stop functions, about ..., 48
Stopping time - SS1, SS2 (C15305), 49 , 58 , 63 , 65 , 128
Stored module ID (C15017), 95 , 120

T

Terms, definitions, 6
Time - RTC parameter setting (C15014), 119
Time - sec. parameter setting (C15015), 119
Time for parameter set creation (C15013), 119
Tolerance of speed comparison (C15411), 47 , 133
Torque, safe torque off, 54
Total index, 142

V

Validity of the documentation, 15