

Handbook | VLT® Frequency Converters

Facts Worth Knowing about Frequency Converters



Preface

In 1968, Danfoss was the first company in the world to commence mass production of Frequency Converters, for variable speed control of three-phase induction motors. Today FC's are an increasingly important component for optimising motor operation, and the system attached to the motor. FC's are now used in an expanding range of applications, with the following main objectives in mind:

- Energy efficiency optimisation: Converting from fixed to variable speed in applications with varying load, delivers a step change in energy savings. In fact these days, modern motor technology always requires advanced control in order to run optimally at all speeds.
- Factory automation: Continuously escalating demand for factory throughput leading to a higher degree of automation implies a growing need for variable speed solutions.
- Process control and optimisation: Improved process control often requires variable speed motor control and leads to more precise control, higher throughput, or comfort, depending on the application.

The fundamentals of FC technology persist, but many elements are also rapidly changing. Increasingly, software is embedded in today's products, offering new functionalities and enabling the FC to play a larger role in the system. New motor types are appearing, placing additional demands on motor control. This in turn means the FC must be able to control an expanding variety of motor types, without burdening the end user with more complexity. In addition, new energy efficiency requirements lead to more variable speed applications, eventually making all motors variable speed and controlled by a FC.

With this latest update of "Facts worth knowing about frequency converters", we at Danfoss would like to continue the heritage from previous versions of this book. We are proud of what we do and are enthusiastic about FC'sR. With this book we hope to convey some of this enthusiasm to you!

If you would like to learn more, please feel free to contact Danfoss.

Jakob Fredsted

Vice President, Research & Development

Danfoss Power Electronics A/S

Content

	Page
0 Introduction	7
0.1 Speed Control of Electrical Motors	7
0.2 Why use Speed Control?	8
0.3 How to Adjust the Motor Speed	8
0.4 Frequency Converteres	9
1 Electric Motors	10
1.1 Overview	10
1.2 Fundamentals	11
1.2.1 Stator and Rotor	11
1.2.2 Power and Torque	12
1.2.3 AC and DC Motors	13
1.2.4 Electromagnetic Induction	13
1.2.5 Poles, Synchronous Speed and Asynchronous Speed	14
1.2.6 Efficiency and losses	15
1.3 Asynchronous Motors	17
1.3.1 Rotating Field	17
1.3.2 Squirrel Cage Motor	19
1.3.3 Slip, Torque and Speed	21
1.3.4 Typical Operating Conditions	23
1.3.5 Changing Speed	24
1.3.6 Motor Nameplate and Star or Delta Configuration	27
1.4 Synchronous Motors	29
1.4.1 Permanent Magnet (PM) Motors	29
1.4.1.1 Back EMF	31
1.4.1.2 Torque and Speed Range	32
1.4.2 Brushless DC (BLDC) or Electronically Commutated (EC) Motors	33
1.4.3 Line Start PM Motor (LSPM Motor)	34
1.4.4 Reluctance Motors	35
1.4.5 Synchronous Reluctance Motor with Squirrel Cage	36
1.4.6 Synchronous Reluctance Motor (SynRM)	37
1.4.7 Switched Reluctance Motor (SRM)	39
2 Frequency Converters	41
2.1 Direct Converters	41
2.2 Converters with Intermediate Circuit	42
2.3 Rectifier	44
2.3.1 Uncontrolled Rectifiers	45

	Page
2.3.2 Semi-controlled Rectifiers	46
2.3.3 Fully-controlled Rectifiers	47
2.3.4 Active Front-End/Active Infeed	48
2.4 Intermediate Circuit	48
2.4.1 Variable Intermediate Circuit	49
2.4.2 Constant Intermediate Circuit	51
2.5 Inverter	52
2.6 Modulation Principles	55
2.6.1 Pulse Amplitude Modulation (PAM)	55
2.6.2 Pulse with Modulation (PWM)	56
2.6.3 Asynchronous PMV	59
2.6.3.1 SFAVM	59
2.6.3.2 60° AVM	62
2.7 Control Circuit and Methods	63
2.7.1 Simple Control Method	65
2.7.2 Solar Control with Compensation	66
2.7.3 Space Vector with and without Feedback	67
2.7.3.1 Space Vector (Open Loop)	67
2.7.3.2 Space Vector (Closed Loop)	68
2.7.4 Open Loop and Closed Flux Vector Control	69
2.7.4.1 Flux Vector (Open Loop)	69
2.7.4.2 Flux Vector (Closed Loop)	70
2.7.5 Servo Drive Control	70
2.7.6 Control Conclusions	71
2.8 Danfoss Control Principles	71
2.8.1 Danfoss VVCplus Control Principle	72
2.8.2 Danfoss Flux Vector Control Principle	76
2.9 Standards and Legislations	77
3 Frequency Converters and Motors	78
3.1 Basic Principles	78
3.1.1 U/f Operation and Field Weakening	78
3.1.2 87 Hz Characteristics	80
3.1.3 Running in Current Limit	82
3.2 Compensations	82
3.2.1 Load-independent Start Compensations	83
3.2.2 Load-dependent Start Compensations	83
3.2.3 Load Compensations	84
3.2.4 Slip Compensations	84
3.2.5 PM Motor and SynRPM compensations	85

	Page
3.3 Automatic Motor Adaption (AMA).....	86
3.4 Operation.....	87
3.4.1 Motor Speed Control	87
3.4.2 Reversing	88
3.4.3 Acceleration and Deceleration Ramps (Ramp Up and Down).....	89
3.4.4 Motor Torque Control	91
3.4.5 Watchdog	92
3.5 Dynamic Brake Operation.....	93
3.5.1 Extending Deceleration Ramp	94
3.5.2 Motor as a Breaking Resistor.....	94
3.5.3 Brake Chopper Circuit (Brake Module) and Resistor	95
3.5.4 Use of a Regenerative Braking Unit.....	95
3.6 Static Brake Operation	96
3.6.1 Coasting to Stop.....	97
3.6.2 DC Braking.....	97
3.6.3 DC Hold	97
3.6.4 Electromechanical Brake	97
3.7 Motor Heating and Thermal Monitoring.....	98
3.8 Functional Safety	100
4 Saving Energy with Frequency Converters	104
4.1 Potential	104
4.2 Motor + Frequency Converter Efficiency	105
4.3 Classification of Energy Efficiency	106
4.4 Energy Efficient Motor Start.....	109
4.5 Energy Efficient Motor Control	111
4.6 Load over Time.....	113
4.6.1 Applications with Variable Torque	113
4.6.2 Applications with Constant Torque	115
4.7 Life Cycle Costs	116
4.8 System Savings	117
4.9 Using Regenerated Power	119
5 Electromagnetic Compatibility	122
5.1 EMI and EMC.....	122
5.2 EMC and Frequency Converters	123
5.3 Grounding and Shielding	125
5.4 Installations with Frequency Converters.....	130
5.5 Legislation and Standards	131

	Page
6 Protection against Electric Shock and Energy Hazards	133
6.1 General	133
6.2 Mains Supply System.....	134
6.3 Additional Protection	137
6.4 Fuses and Circuit Breakers.....	139
7 Mains Interference	142
7.1 What are Harmonics?.....	142
7.1.1 Linear Loads.....	142
7.1.2 Non-linear Loads	143
7.1.3 The Effect of Harmonics in a Power Distribution System	145
7.2 Harmonic Limitation Standards and Requirements.....	147
7.3 Harmonic Reduction Methods in Frequency Converters.....	147
7.3.1 Passive Harmonic Mitigation	149
7.3.2 Active Harmonic Mitigation	150
7.4 Harmonic Analysis Tools.....	152
7.4.1 VLT® Motion Control Tool MCT 31	153
7.4.2 Harmonic Calculation Software (HCS).....	153
8 Interfaces	154
8.1 Human Machine Interface (HMI).....	154
8.2 Operating Principles of Serial Interfaces	156
8.3 Standard Serial Interfaces in Frequency Converters	158
8.4 Fieldbus Interfaces in Frequency Converters	159
8.5 Fieldbuses Standardisation	161
9 Sizing and Selection of Frequency Converters	164
9.1 Get the Drive Rating Right.....	164
9.2 Rating of the Frequency Converters from Motor Specification	165
9.3 Overload Capacity	166
9.3.1 Energy Efficiency Concerns	168
9.4 Control Range	169
9.5 Derating of FC	170
9.6 Regenerative Energy.....	171
9.7 Motor Cables	172
9.8 Environment	173
9.9 Centralised versus Decentralised Installation.....	175
9.10 Examples.....	177

0 Introduction

By definition, a Frequency Converter (FC) (or frequency changer) is an electronic device that converts alternating current (AC) of one frequency to another frequency. Traditionally, these devices were electro-mechanical machines (motor-generator set). They are sometimes referred to as “dynamic” FC’s. With the invention of solid state electronics, it has become possible to build completely electronic FC’s, which are often referred to as “static” FC’s (no moving parts).

Whilst the principle of converting fixed mains voltage and frequency into variable quantities has always remained virtually the same, there have been many improvements from the first FC’s, which featured thyristors and analogue technology, to today’s microprocessor-controlled, digital units.

Because of the ever-increasing degree of automation in industry, there is a constant need for more automated control and a steady increase in production speeds, so better methods to further improve the efficiency of production plants are being developed all the time.

Today, the FC-controlled, three-phase motor is a standard element in all automated process plants, commercial and public buildings. High-efficiency Induction motors, but especially motor designs such as Permanent Magnet motors, EC motors and Synchronous Reluctance Motors, need regulation with FC’s, many motors cannot even be operated directly from the 3 phase standard power supply.

0.1 Speed Control of Electrical Motors

Different terminologies are used for systems that can control or alter the speed of electrical motors. The most commonly used ones are:

- Frequency Converter (FC)
- Variable Speed Drive(VSD)
- Adjustable Speed Drive (ASD)
- Adjustable Frequency Drive (AFD)
- Variable Frequency Drive (VFD)

While VSD and ASD refer to speed control in general, AFD and VFD are directly connected to adjusting the feeding frequency of a motor. In this context, the abbreviation “drive” is used as well. Throughout this book, the terminology Frequency Converter will be widely used. This wording covers the power electronic part of the devices and the supporting components like current sensors, I/Os and Human Machine Interface (HMI).

0.2 Why use Speed Control?

There are numerous reasons for adjusting the speed of an application:

- Save energy and improve efficiency of systems
- Match the speed of the drive to the process requirements
- Match the torque or power of a drive to the process requirements
- Improve the working environment
- Reduce mechanical stress on machines
- Lower noise levels, for example on fans and pumps

Depending on the application one or the other benefit is predominant. However, speed control is proven to bring significant advantages in many different applications.

0.3 How to Adjust the Motor Speed?

There are three main technologies to realise speed control used in industry. Each has its unique features:

Hydraulic

- Hydro-dynamic type
- Static types

They are often favoured in conveyor applications especially for earth-moving and mining equipment. This is basically due to inherent “soft start” capability of the hydraulic unit.

Mechanical

- Belt and chain drives (with adjustable diameters).
- Friction drives (metallic)
- Variable speed gear

Mechanical solutions are still favoured by many engineers – especially mechanical engineers – for some applications, mainly because of their simplicity and low cost

Electrical

- FC with electrical motor
- Servo systems (for example servo amplifier and servo PM motor)
- DC motor with control electronics
- Slip-ring motor (slip control with wound-rotor induction motor)

Historically, electrical devices for speed control were complex to handle and expensive. They were used for the most challenging tasks where no alternatives were available. The provided list of technical solutions for speed control of motors is not exhaustive

and shall give an insight of the possibilities only. This book will focus on speed control of electrical motors by FC's.

0.4 Frequency Converters

Modern Frequency Converters can be applied to adjust and maintain the speed or torque of a driven machine with an accuracy within $\pm 0.5\%$. This is independent of the load when compared to fixed speed operation of the induction motor, where the speed can vary by as much as 3 – 5% (slip) from no-load to full-load operation.

Motor manufacturers employ a variety of concepts to achieve high efficiency in electrical motors. For users it can be difficult to see the main benefit from one technology to another, but the user will surely observe that energy efficient motors need high technology controls.

In principle, nearly all motors can be operated with control algorithms specially adapted to each motor type. Some manufacturers of FC's relate their design to a narrow group of motor technologies, but many manufacturers have the different algorithms built-in and selectable during commissioning.

For the commissioner it is important that the FC is easy to commission based on data, normally available for the motor type which is used. After commissioning the user must be confident that the system is really as easy as expected, thus online measurements of actual energy consumption and easy access to important data about the operation is essential.

To ease the selection and ensure the various Government aims of reduction of energy consumption, there is a big motivation for a complete set of regulations.

It must be borne in mind that all system components are important for potential energy savings. According to the German Association of Electrical and Electronics Manufacturers (ZVEI), approximately 10% of the savings can be achieved by using high-efficiency motors, 30% of the savings are achieved by variable speed, but as much as 60% of the potential savings are achieved by looking at the overall system and optimising accordingly.

With that in mind, please read all chapters in this book and remember you cannot judge a system by looking at only one or few of the components involved.

We wish you an interesting read.

1 Electric Motors

1.1 Overview

An electric motor is an electromechanical device that converts electrical energy into mechanical energy. The reverse process of producing electrical energy from mechanical energy is performed by a generator.

The operating demands of the electric motor, especially in industry, have been enormous. Robustness, reliability, size, energy efficiency, and price are only some of these criteria. The differing needs have resulted in the development of different types of electric motors. The following diagram gives a general overview of the most commonly used electric motor technologies.

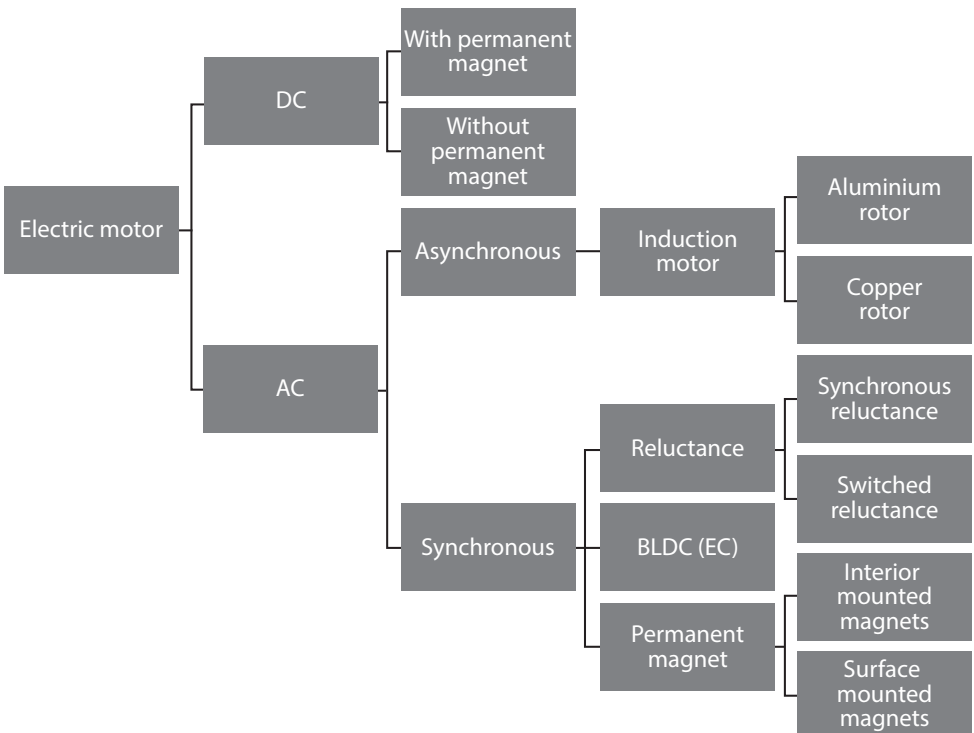

Fig. 1.1 Overview of the most common electric motor technologies

1.2 Fundamentals

1.2.1 Stator and Rotor

The construction of all rotating electric motors consists in principle of two main components.

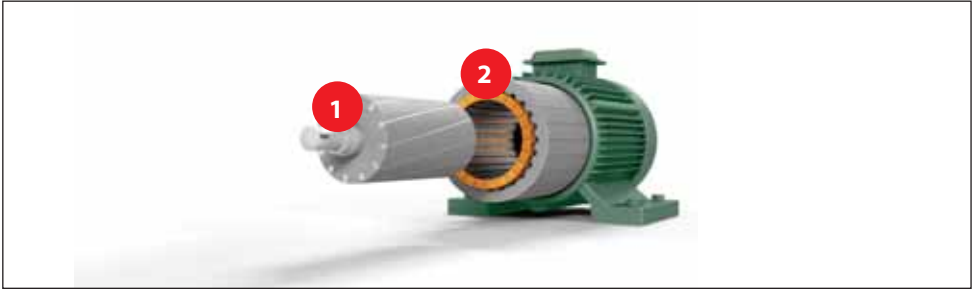

Fig. 1.2 Construction of the asynchronous motor

Stator

The stator (1) is the stationary part of the motor which holds packages of laminations where the electrical windings are placed.

Rotor

The rotor (2) is the rotating part of the motor which is mounted on the motor shaft. Like the stator, the rotor is made of thin iron laminations which hold the rotor windings.

One variation is the outer rotor motor. Unlike the inner rotor design, the stator is placed in the middle of the motor and the rotor rotates around the stator. This construction is used in some fan applications where the fan blades are directly mounted on the rotor. Unless otherwise mentioned, all the following explanations are related to inner rotor design.

The connection dimensions of typical industrial motors are defined in IEC standards. However not all motors fulfill these requirements. For example, NEMA frame motor dimensions differ from IEC standards, due to the conversion from the metric to the imperial system.

1.2.2 Power and Torque

The rated output of electric motors is defined within a standard range. This standardisation allows users to choose between different motor manufacturers for specific applications. The “standard” output range and its increments differ from country to country and region to region. It is recommended to find out what manufacturers define as standard in their catalogues. On average, motors with frame size up to 315 (ca. 200 kW) can be regarded as standard motors with standard dimensions.

Horsepower [hp] is the imperial unit used for motor power. If this unit is specified, it can be converted as follows: 1 hp = 0.736 kW or 1 kW = 1.341 hp.

Table 1.1 shows the typical industrial standard rated output power in [kW] and [hp].

kW	0.18	0.25	0.37	0.55	0.75	1.10	1.50	2.20	3.00	4.00	5.50	7.50	11.0
hp					1.00		2.00	3.00		5.00	7.00	10.00	15.0
kW	15.0	18.5	22.0	30.0	37.0	45.0	55.0	75.0	90.0	110.0	132.0	160.0	200.0
hp	20.0		30.0	40.0	50.0	60.0	75.0	100					

Table 1.1 Rated motor output power

Besides power, torque is an important characteristic of the motor. Torque indicates the strength of rotation of the motor shaft. Power has a direct relationship to torque and can be calculated when torque and speed are known.

$$P = \frac{T \times n}{9.550}$$

P = Power [kW]

T = Torque [Nm]

n = Speed [RPM]

The factor 9.550 used in the formula results from the conversion of units:

- Power from the base units W (watt) to nameplate units kW (kilowatt)
- Speed from the base unit s^{-1} (revolutions per second) to nameplate min^{-1} (revolutions per minute)

1.2.3 AC and DC Motors

The first electric motor, a DC motor, was built around 1833. Speed control of this type of motor is simple, and met the requirements of many different types of applications at the time. The DC motor is controlled by supplying a DC voltage whose magnitude influences the speed of the rotor. Voltage applied to stator and rotor windings results in magnetic fields which attract or repel each other, leading to rotor movement. Energy supplied to the rotor is transmitted via brushes, typically made of graphite, to a commutator. The commutator ensures that the next winding is energised to achieve a continuous rotation. The brushes are subject to mechanical abrasion and require maintenance or periodic replacement. The importance of DC motors has decreased over time and they are rarely used in power ranges above a few hundred watts today.

Compared to DC motors, AC motors are much simpler and more robust. However, AC motors typically have a fixed speed and torque characteristic. Because of these fixed characteristics, for many years AC motors could not be used for many diverse or special applications. They are nonetheless used in most applications to transform electrical energy into mechanical energy.

The functional principle of AC motors is based on the effects of a rotating magnetic field. The rotating field is generated either from a multi-phase fed AC source (typically three-phase) or from a single phase source assisted by capacitors or inductances to achieve phase shift.

This book focuses on AC motors, particularly on asynchronous motors, as the requirements for operation with FC's in adjustable speed drive applications for various motor types can be derived from this motor technology. DC motors will not be addressed further.

1.2.4 Electromagnetic Induction

Most electric motors operate through the interaction of magnetic fields and current-carrying conductors to generate force. This is the reverse process of producing electrical energy from mechanical energy, performed by generators such as an alternator or a dynamo on a bicycle.

a) Generator principle, induction by motion

When a force (F) acts on a conductor and moves it across a magnetic field (B), a voltage is induced. If the conductor is part of a closed circuit, a current (I) flows, see Fig. 1.3 Principle for electromagnetic induction.

b) Motor principle

In motors, the induction principle is utilised in the reverse order: a current-carrying conductor located in a magnetic field is influenced by a force (F) which results in a movement.

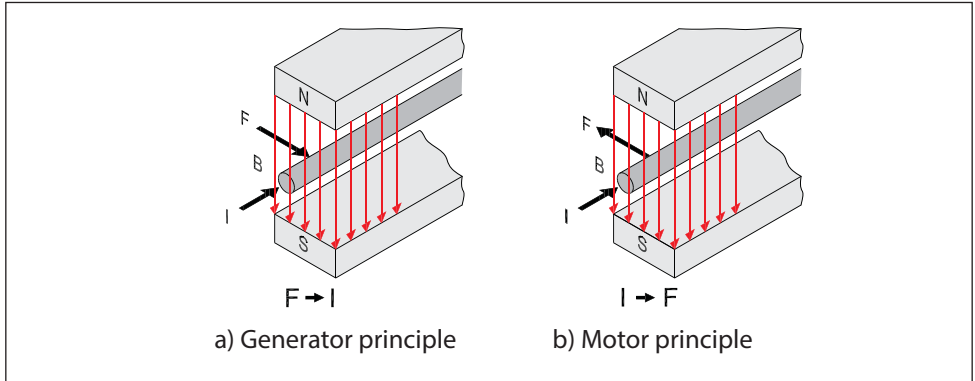

Fig. 1.3 Principle for electromagnetic induction

In both cases a magnetic field is required. In Fig. 1.3 Principle for electromagnetic induction the magnetic field originates from a permanent magnet, but in a motor the magnetic field is generated in the stator. Typically, this is achieved by applying voltage to the stator windings. The conductors affected by the electromagnetic force are located in the rotor.

1.2.5 Poles, Synchronous Speed and Asynchronous Speed

The synchronous speed of a motor can be calculated when the supply frequency and number of pole pairs are known.

$$n_0 = \frac{f \times 60}{p}$$

f = frequency [Hz]

n_0 = synchronous speed [min^{-1}]

p = pole pair number

While the frequency is determined by the grid or the FC, the number of poles is determined by the way the stator coils are connected.

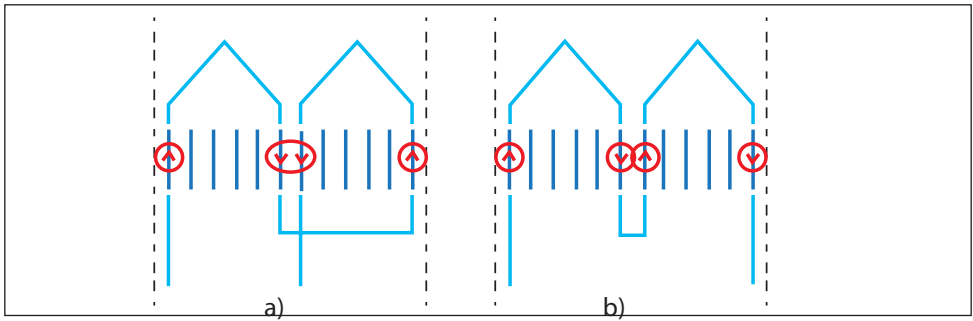

Fig. 1.4 Two coils in one phase connected in series to a) two poles b) four poles

Table 1.2 Pole pairs (p) or pole number and synchronous motor speed – lists the number of poles corresponding to synchronous speed (n_0) at 50 and 60 Hz supply. Higher pole numbers are possible but rarely used nowadays.

Pole pairs p	1	2	3	4	6
Pole number 2p	2	4	6	8	12
n_0 [min ⁻¹] (50 Hz supply)	3000	1500	1000	750	500
n_0 [min ⁻¹] (60 Hz supply)	3600	1800	1200	900	600

Table 1.2 Pole pairs (p) or pole number and synchronous motor speed

Synchronous means “simultaneous” or “the same”. This means in synchronous motors the speed of the rotor is the same as the speed of the rotating field. If the rotor speed is affected by slip (see also section 1.3.3 Slip, Torque and Speed and therefore lower than the speed of the rotating field, the motor is classified as asynchronous, meaning “not simultaneous” or “not the same”.

1.2.6 Efficiency and Losses

The motor draws electrical power from the mains. At a constant load, this power is greater than the mechanical power the motor can output to the shaft, due to various losses in the motor. The ratio between the output power P_2 and input power P_1 is the motor efficiency:

$$\eta = \frac{P_2}{P_1} = \frac{\text{output power}}{\text{input power}}$$

The efficiency depends on the motor principle, components (for example lamination quality), amount of active material (for example, due to lamination or use of magnets), size of the motor (rated power) and number of poles.

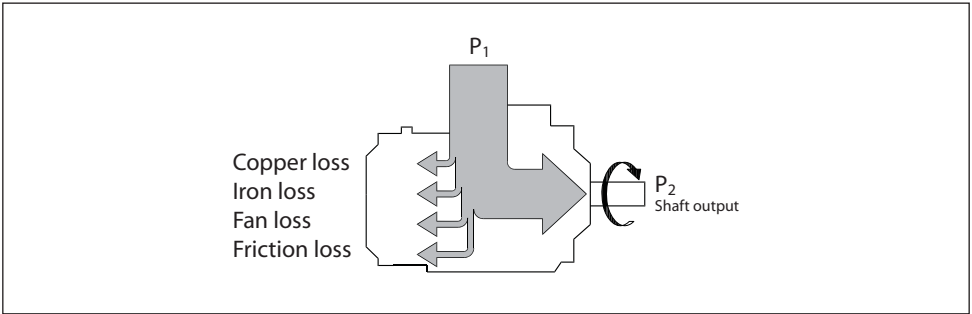

Fig. 1.5 Typical losses in the motor

The losses in the motor illustrated in Fig. 1.5 Typical losses in the motor comprise:

- Copper losses as a result of the resistances of the stator and rotor windings
- Iron losses consisting of hysteresis losses and eddy-current losses

Hysteresis losses occur when iron is magnetised by an alternating current (AC).

The iron is magnetised and demagnetised repeatedly (that is, 100 times per second with a 50 Hz supply). Magnetising and demagnetising both require energy. The motor supplies power to cover the hysteresis losses, which increase with frequency and the strength of magnetic induction.

Eddy-current losses occur because the magnetic fields induce electric voltages in the iron core as in any other conductor (see Fig. 1.6 Eddy-currents are reduced by the laminated form of the motor core). These voltages produce currents that cause heat losses. The currents flow in circuits at right angles to the magnetic fields.

The eddy-current losses are dramatically reduced by dividing the iron core into thin laminations.

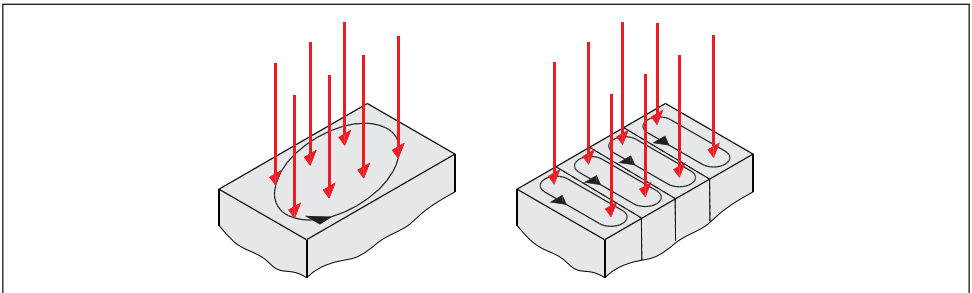

Fig. 1.6 Eddy-currents are reduced by the laminated form of the motor core

- Fan losses occur due to the air resistance of the motor fan
- Friction losses occur in the ball bearings holding the rotor

When determining the efficiency and motor output power, the losses in the motor are normally subtracted from the supplied power. The supplied power is measured, whereas the losses are often calculated or determined experimentally.

1.3 Asynchronous Motors

To understand clearly how an adjustable speed drive system works, it is necessary to understand the principles of operation of this type of motor. Although the basic design has not changed much in the last decades, modern insulation materials, computer-based design optimisation techniques as well as automated manufacturing methods have resulted in lower cost per kilowatt power and higher efficiency for a given motor size.

The information in this book will apply mainly to the so-called “squirrel-cage” three-phase asynchronous motor, which is the type commonly used with FC’s.

1.3.1 Rotating Field

When applying a multi-phase AC source (typically three-phase) to a suitable winding system, a rotary magnetic field is generated which rotates in the air gap between the stator and the rotor. If one of the phase windings is connected to a supply phase, a magnetic field is induced.

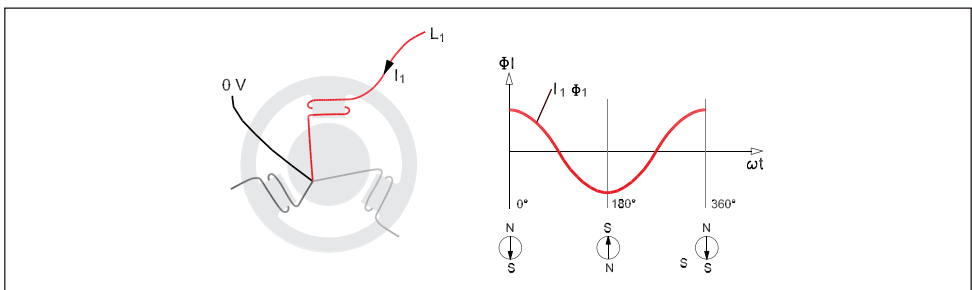

Fig. 1.7 One phase produces an alternating field

The magnetic field in the stator core has a fixed location, but its direction varies, as shown in Fig. 1.7 One phase produces an alternating field. The speed of rotation is determined by the supply frequency. At a frequency of 50 Hz, the field changes direction 50 times per second.

If two phase windings are connected to the respective supply phases, two magnetic fields are induced in the stator core. In a two-pole motor, one field is displaced by 120 degrees relative to the other. The maximum field values are also displaced in time, as shown in Fig. 1.8 Two phases produce an asymmetrical rotating field.

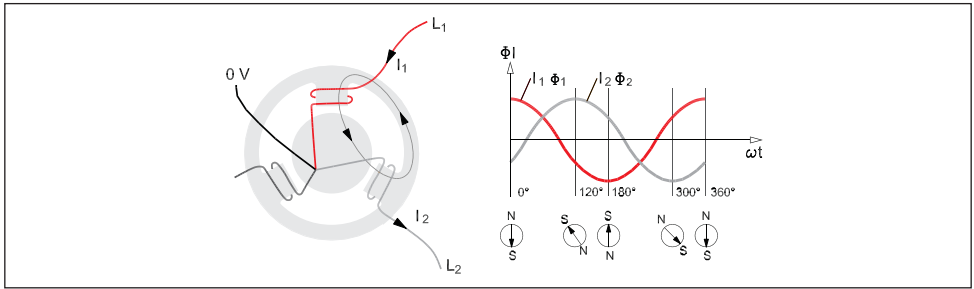

Fig. 1.8 Two phases produce an asymmetrical rotating field

This produces a rotating magnetic field in the stator which is highly asymmetrical until the third phase is connected. When the third phase is connected, there are three magnetic fields in the stator core. There is a 120° displacement between the three phases, as shown in Fig. 1.9 Three phases produce a symmetrical rotating field.

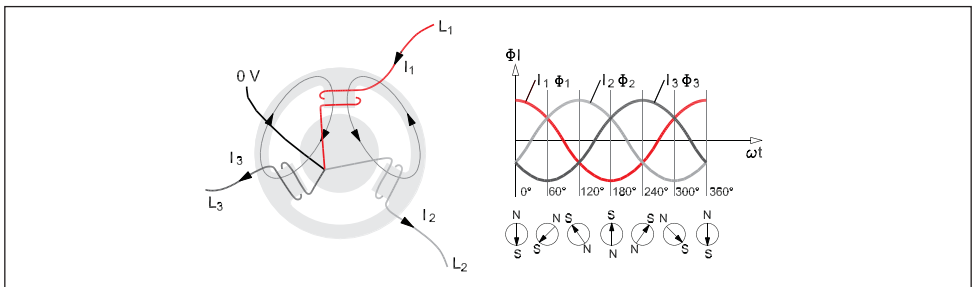

Fig. 1.9 Three phases produce a symmetrical rotating field

The stator is now connected to the three-phase supply. The magnetic fields of the individual phase windings form a symmetrical rotating magnetic field. This magnetic field is called the rotating field of the motor.

The amplitude of the rotating field (φ) is constant and 1.5 times the maximum value (φ_{\max}) of the alternating fields. It rotates at the synchronous speed resulting from the pole pair number and supply frequency (see also section 1.3.3 Slip, Torque and Speed).

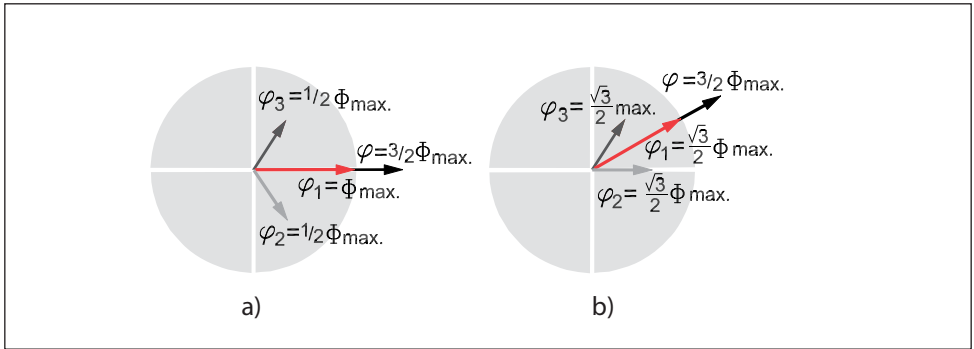

Fig. 1.10 Magnetic field components

The representation of the rotating field as a vector with a corresponding angular velocity describes a circle, shown in Fig. 1.10 Magnetic field components. The magnitude of the magnetic field φ as result of the components (φ_1 , φ_2 , φ_3) is constant also at different moments (a and b). As a function of time in a coordinate system, the rotating field describes a sinusoidal curve. The rotating field becomes elliptical if the amplitude changes during a rotation.

With single phase motors the phase shift which determines the rotation direction of the motor is created by a capacitor or an inductance which also results in an elliptical field.

1.3.2 Squirrel-cage Motor

The squirrel-cage rotor is the most frequently-used rotor type, and is used in the squirrel-cage motor. Unlike the stator, where the coils have many windings, in the squirrel-cage motor, only one winding is placed in the slots of the rotor lamination. This is typically done with aluminium or copper rods. The rods are short-circuited at each end of the rotor by a ring made out of the same material. Copper has the advantage that it has a better conductivity than aluminium which results in lower losses and a higher efficiency. Drawbacks compared to aluminium are higher prices, lower starting torques and higher melting temperature which complicate the casting and leads to a higher tooling efforts.

A variant of the squirrel-cage rotor is the slip-ring rotor which has wound coils for each phase. The coils are connected to slip-rings. Brushes sliding on the slip-ring allow the connection of external resistors which modifies the motor behaviour (see also section 1.3.5 Changing Speed). If the slip-rings are short-circuited, the rotor acts as a squirrel-cage rotor.

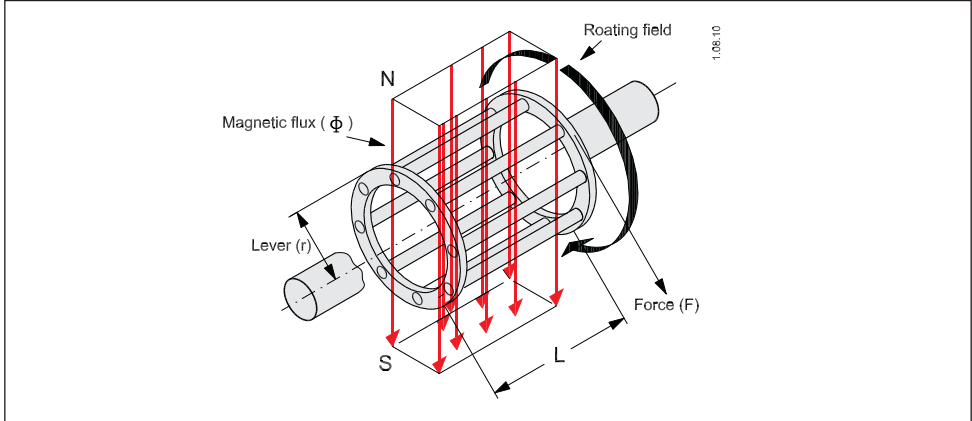

Fig. 1.11 Operational field and squirrel-cage rotor

The rotor movement of the squirrel-cage motor is created as follows: A rotor rod placed in the rotating field is passed by a series of magnetic poles, as shown in Fig. 1.11. The magnetic field of each pole induces a current (I_w) in the rotor rod, which is influenced by a force (F). This force is determined by the flux density (B), the induced current (I_w), the length (L) of the rotor within the stator, and the angle (θ) between the force and the flux density. Assuming that $\theta = 90^\circ$, the force is:

$$F = B \times I_w \times L$$

The next pole passing the rod has an opposite polarity. It induces a current in the opposite direction to the previous one. Since the direction of the magnetic field has also changed, the force acts in the same direction as before as shown in Fig. 1.12b Induction in the rotor rods.

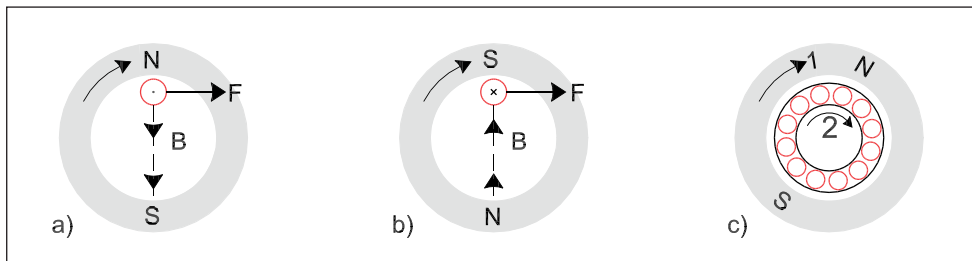

Fig. 1.12 Induction in the rotor rods

When the entire rotor is located in the rotating field, see Fig. 1.12c Induction in the rotor rods, the rotor rods are affected by forces that cause the rotor to rotate. The rotor speed (2) does not reach the speed of the rotating field (1) since no currents are induced in the cage bars when it is rotating at the same speed as the field.

1.3.3 Slip, Torque and Speed

As described in sections 1.2.5 Poles, Synchronous Speed and Asynchronous Speed and 1.3.2 Squirrel Cage Motor, under normal circumstances the rotor speed (n_n) of asynchronous motors is slightly lower than the speed (n_0) of the rotating field. The difference between the speed of the rotating field and the rotor is called slip (s) where:

$$s = n_0 - n_n$$

The slip is often expressed as a percentage of the synchronous speed and is typically between 1 and 10 percent.

$$s = \frac{(n_0 - n_n) \times 100}{n_0}$$

The individual forces in the rotor rods combine to form the torque (T) on the motor shaft (see section 1.3.2 Squirrel Cage Motor). With a given value of force (F) and radius (r) the motor torque is: $T = F \times r$.

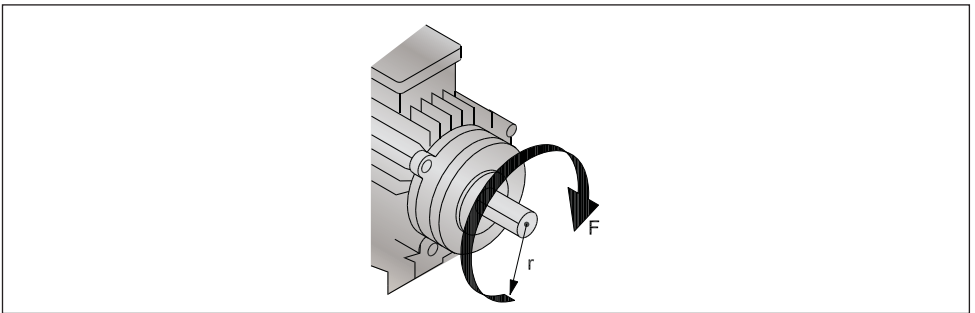

Fig. 1.13 Torque on the motor shaft is the force (F) x radius (r)

The relationship between motor torque, speed and current of asynchronous motors has a characteristic curve, shown in Fig. 1.14 Principal motor current and torque characteristics. This curve depends on the rotor slot design and the rod material.

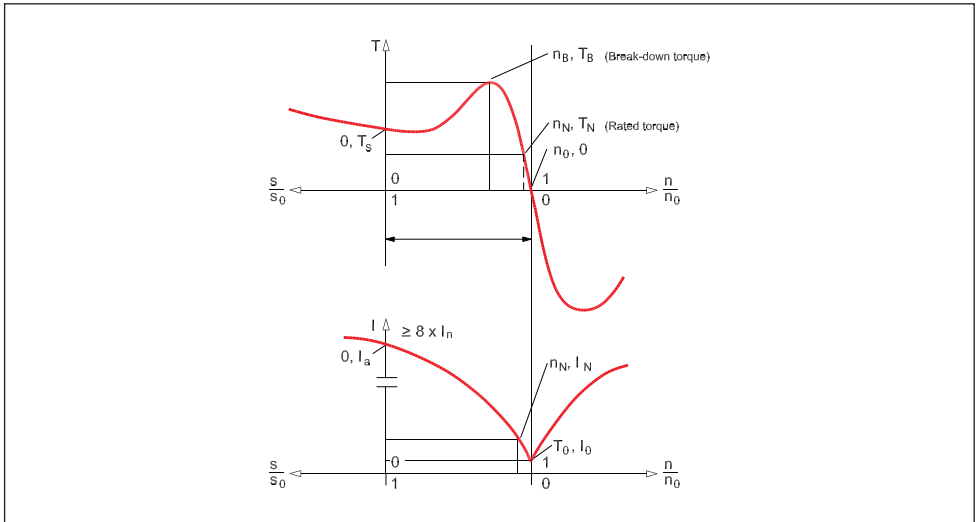

Fig. 1.14 Principal motor current and torque characteristics

The motor operating range ($0 < n/n_0 < 1$) can be split up into two ranges:

- Starting range ($0 < n/n_0 < n_B/n_0$)
- Operating range ($n_B/n_0 < n/n_0 < 1$)

These ranges have the following characteristics:

Starting torque T_a . This is the torque the motor produces with the rated voltage and rated frequency applied at standstill.

Stall torque T_B at stall speed n_B . This is the highest torque the motor can produce when the rated voltage and rated frequency are applied.

Rated motor torque T_n at nominal speed n_n .

The rated values of the motor are the mechanical and electrical values for which the motor was designed in accordance with the IEC 60034 standard. The rated values, also called motor specifications or motor ratings, are stated on the motor nameplate.

The rated values indicate the optimal operating point for the motor, when connected directly to the mains.

Apart from the normal motor operating range, there are two braking ranges.

- $n/n_0 > 1$: the motor is driven by the load above its synchronous speed (n_0) operating as a generator. In this region, the motor produces a counter torque and simultaneously returns power to the supply grid.
- $n/n_0 < 0$: braking is called regenerative braking or plugging.

If two phases of a motor are suddenly interchanged, the rotating field changes direction. Immediately afterwards, the speed ratio n/n_0 is 1. The motor, previously loaded with torque T , now brakes with its braking torque. If the motor is not disconnected at $n = 0$, it will continue to run in the new rotational direction of the magnetic field.

1.3.4 Typical Operating Conditions

In principle, asynchronous motors have six coils: three coils in the stator and three coils in the squirrel-cage rotor (which behaves magnetically as if consisted of three coils). A subset of these coils can be used as the basis for generating an equivalent circuit that makes the operating principle of the motor easier to understand, especially when the frequency of the supply voltage changes or varies.

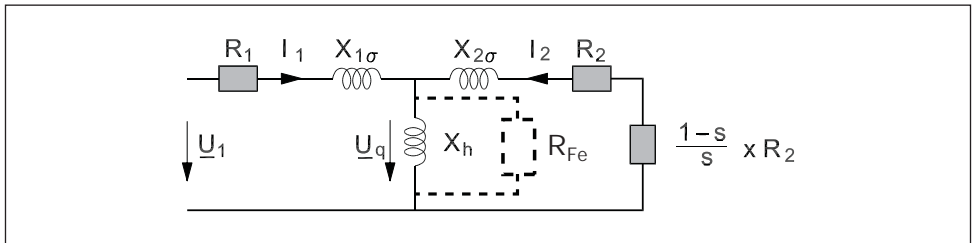

Fig. 1.15 Equivalent circuit diagram (one phase) for a motor operating under load

Applying a supply voltage (U_1) results in a current in the stator (I_1) and the rotor (I_2) which is limited by the resistance in stator (R_1) and rotor (R_2) and the reactance in stator ($X_1 \sigma$) and rotor ($X_2 \sigma$) in rotor. While the resistance is independent of the supply frequency the reactance has an influence.

$$X_L = 2 \times \pi \times f \times L$$

X_L = reactance [Ω]

f = frequency [Hz]

L = inductance [H]

The coils mutually influence each other by means of magnetic induction. The rotor coil induces a current in the stator coil and vice versa. This mutual effect means that the two electric circuits can be interconnected via a common element consisting of R_{Fe} and X_{lr} , which are called the transverse resistance and reactance. The current the motor draws for magnetising the stator and the rotor flows through this common element. The voltage drop across the "transverse link" is the induction voltage (U_q). As R_{Fe} is very small and is neglected in the following explanations.

Standard operation

When the motor operates in its normal operating range, the rotor frequency is, due to the slip, lower than the rotating field frequency. In the equivalent circuit diagram, the effect is described by a change in the rotor resistance R_2 by the factor $1/s$. R_2/s can be expressed as $R_2 + R_2 \times (1 - s)/s$ where $R_2 \times (1 - s)/s$ represent the mechanical motor load.

No-load situation

The slip s is small at no-load (idle) operation. This means that $R_2 \times (1 - s)/s$ is high. Consequently, almost no current can flow through the rotor. Ideally, this is comparable to removing the resistor that represents the mechanical load from the equivalent circuit.

The induced voltage (U_q) is often confused with the motor terminal voltage. This is due to the simplification of the equivalent circuit diagram to make it easier to understand various motor conditions. However, the induced voltage only approximately corresponds to the terminal voltage in no-load operation.

Locked rotor situation

The slip increases when the motor is operating under load. Therefore $R_2 \times (1 - s)/s$ will decrease. When the rotor is locked the slip is 1 and hence the current which increases with the load reaches its maximum.

The equivalent circuit diagram thus corresponds to the conditions applicable to the asynchronous motor in normal practice. It can be used in numerous cases for describing conditions in the motor.

1.3.5 Changing Speed

The motor speed n is dependent upon the rotational speed of the magnetic field and can be expressed as:

$$n = n_0 - n_s = \frac{(1 - s) \times f}{p}$$

The motor speed can therefore be changed by changing:

- The pole pair number p of the motor (for example, pole-changing motors)
- The motor slip s (for example, slip-ring motors)
- The motor supply frequency f (for the motor)

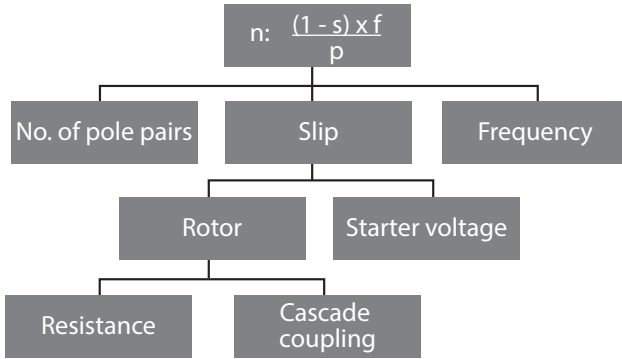

Fig. 1.16 Different options for changing the motor speed

Pole number control

The rotational speed of the magnetic field is determined by the number of pole pairs in the stator. In the case of a two-pole motor, the rotational speed of the magnetic field is 3000 RPM at a motor supply frequency of 50 Hz. For a four-pole motor the speed is 1500 RPM.

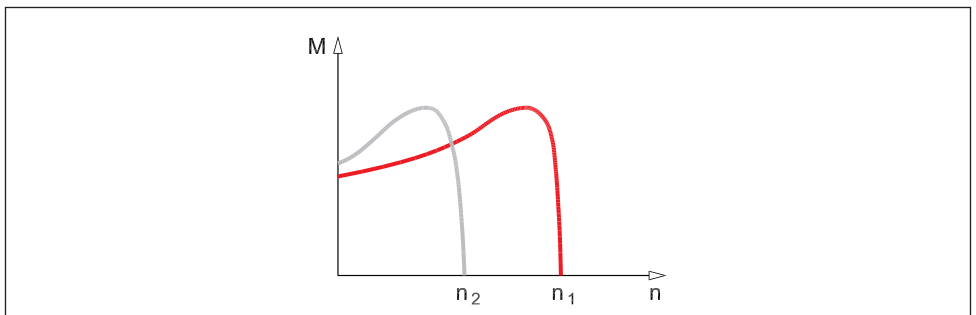

Fig. 1.17 Torque characteristics when changing pole number

Motors can be designed to have two or more different pole-pair numbers. This is done by using a special arrangement of the stator windings (Dahlander winding) in the slots and/or by using more separate and isolated windings in the slot.

The speed is changed by switching the stator windings to change the number of pole pairs in the stator. By switching from a small pole-pair number (high speed) to a high pole-pair number (low speed), the actual motor speed can be dramatically reduced, for example, from 1500 to 750 RPM. With rapid switching from higher to lower speed, the motor runs through the regenerative range. This places a considerable load on the motor and the mechanism of the driven machine which can cause damage to motor and machinery.

Slip control

Controlling the motor speed using slip can take place in two different ways: either by changing the stator supply voltage or by modifying the rotor. It should be mentioned that these methods involve considerable thermal losses. Please refer to other sources of information if more is needed.

Rotor control

Controlling the motor speed using the rotor can be made in two different ways:

- Resistors are inserted in the rotor circuit. These types of motors are called “slip-ring” motors. The trade-off using this method is higher power losses in the rotor.
- Rotor circuits are cascaded with other electrical machines or rectifier circuits. The rotor circuit is then connected via slip rings to DC machines or to controlled rectifier circuits instead of resistors. The DC machine supplies the rotor circuit with additional variable voltage making it possible to change the rotor speed and magnetisation.

Frequency regulation

With a variable frequency supply, it is possible to control the motor speed with minor additional losses. The rotational speed of the magnetic field and hence the rotor speed changes with the frequency. To maintain the motor torque, the motor voltage must change together with the frequency as shown in Fig. 1.18 Torque characteristics with voltage/frequency control.

With a constant ratio of motor supply voltage to frequency, the magnetisation in the rated motor operating range is also constant.

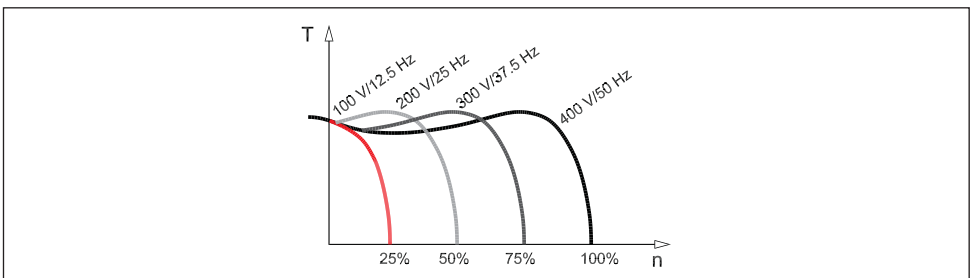

Fig. 1.18 Torque characteristics with voltage/frequency control

At low speed the ratio must be adjusted to compensate for the ohmic losses. Further forced cooling may be required in this speed range.

1.3.6 Motor Nameplate and Star or Delta Configuration

Normally the motor has a nameplate on it which has all essential motor data. Additional data are available in the motor catalogue or can be obtained from the manufacturer.

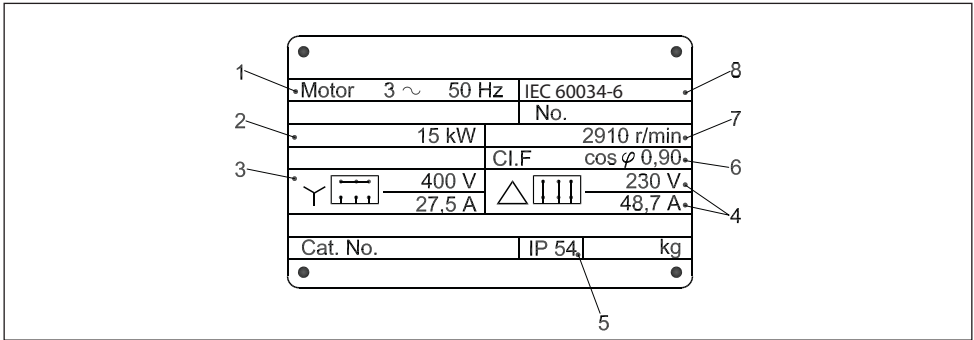

Fig. 1.19 Motor nameplate shows essential data

The nameplate shown has the following information:

1. It is a three-phase AC motor with a rated frequency of 50 Hz
2. Rated output (shaft) power is 15 kW
3. The stator windings can be connected in series (star) with a rated voltage of 400 V and rated (apparent) current of 27.5 A
4. Alternatively, the stator windings can be connected in parallel (delta) with a rated voltage of 230 V and rated (apparent) current of 48.7 A
5. It has an IP 54 protection
6. Insulation class F (155 °C) and a power factor (cos. φ) of 0.90.
7. Rated speed 2910 RPM (a two-pole motor) is the motor speed at the rated voltage, rated frequency and rated load
8. Fulfils the IEC 60034-6 standards

Some motor data (torque, efficiency, etc.) can be calculated using the nameplate data. For example the power factor can be used to calculate the active and reactive components of the motor current.

Pay special attention to the rated motor voltages in star and delta. If the supply is higher than the rated voltage of the applied configuration, the motor will be damaged. The connection itself can be often changed by rearranging the jumpers at the motor terminal.

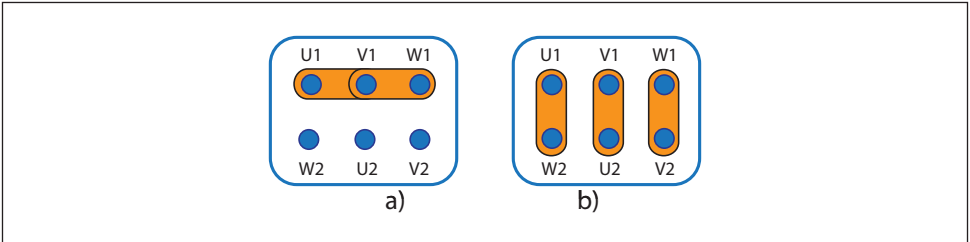

Fig. 1.20 Star (a) and delta (b) configuration of motors via jumpers on the terminal block

In delta connection the full supply voltage is applied to each motor phase but the current is reduced by the factor $\sqrt{3}$. In star connection the current is maintained, and the voltage is reduced. Therefore the power is the same regardless of the connection due to the fact that the feeding voltages are different.

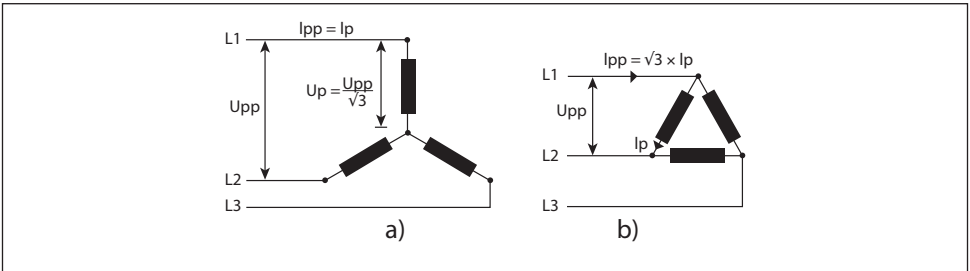

Fig. 1.21 Current and voltage distribution in star (a) and delta (b) configuration

So-called star/delta starters utilise this behaviour for reducing the starting current of a motor. In delta connection, the motor must suit the supplying mains. This means on 400 V mains the motor must have a 690 V star and a 400 V delta rating. At start the motor will be connected in star, reducing current, power and torque to one-third. After the motor has been accelerated the connection will be changed to delta.

Motor voltages in catalogues are often expressed by mentioning the star and delta voltages together (example: 400/230 V λ/Δ or 690/400 V λ/Δ). The lower voltage is always related to delta and the higher to the star connection.

The relation of the current is vice versa: the lower current relates to star configuration, and the higher current relates to delta configuration.

1.4 Synchronous Motors

The synchronous motor is defined by the fact that the rotor rotates at the same speed as the magnetic field created by the stator windings. The design of the stator is in many cases similar to that of asynchronous motors, with distributed windings. Some manufacturers use concentric windings (in slot) which enable a more compact motor design and require less copper. The energy savings achieved by the reduced use of copper are however often eaten up by additional losses, which result in harmonics in the air gap flux caused by the construction.



Fig. 1.22 Distributed windings.

1.4.1 Permanent Magnet (PM) Motors

The simplest way to build a permanent magnet motor (PM motor) is to replace the squirrel-cage rotor of an asynchronous motor with a rotor which is equipped with permanent magnets. When applying a suitable voltage to the stator, a rotating magnetic field will be created in the air gap. The rotor will follow the field at synchronous speed because the magnets are attracted by the rotating field. If the difference between rotor speed and the speed of the magnetic field is too big the motor falls out of synchronicity and the motor will stop. Therefore a suitable controller is required which ensures that speed changes are done by adjusting the feeding frequency continuously and not by switching from one speed to another. In the past PM motors were often used in servo applications with focus on fast and precise operation. These servo motors are typically slim and long in order to have a low inertia for high dynamic applications. To utilise the high-efficiency characteristic of PM motors in other applications the principle has been transferred to motors in IEC frame sizes. Standard frequency converters can be used in the majority of PM motor systems for operation if suitable control algorithms are implemented in the device.

In order to magnetise the motor in the best way the controller needs to know the rotor angle at any point in time. In many applications sensorless strategies for determining the rotor angle are sufficient. If the controller is not capable of sensorless control or in high dynamic servo applications, external position feedback devices are used.

In the equivalent diagram the magnets are represented by a voltage source U_p because turning the rotor will result in a voltage induced in the stator. This voltage is called back EMF, see section 1.4.1.1 Back EMF. The absence of motor slip, rotor resistance and inductance indicates that no losses are created in the rotor which results in the very good efficiency.

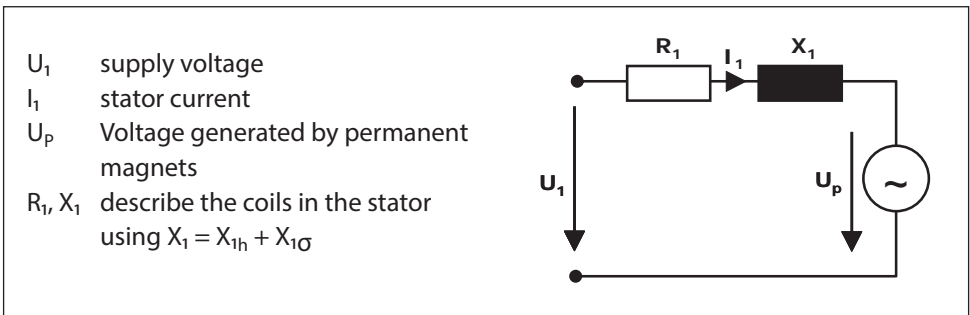

Fig. 1.23 Simplified PM motor equivalent circuit diagram

In general PM motors can be divided into motors with rotors where the magnets are placed on the surface (SPM motor) or internally (IPM motor). The placement of the magnet results in different shapes of the resulting magnetic field and is described by the inductances L_d and L_q .

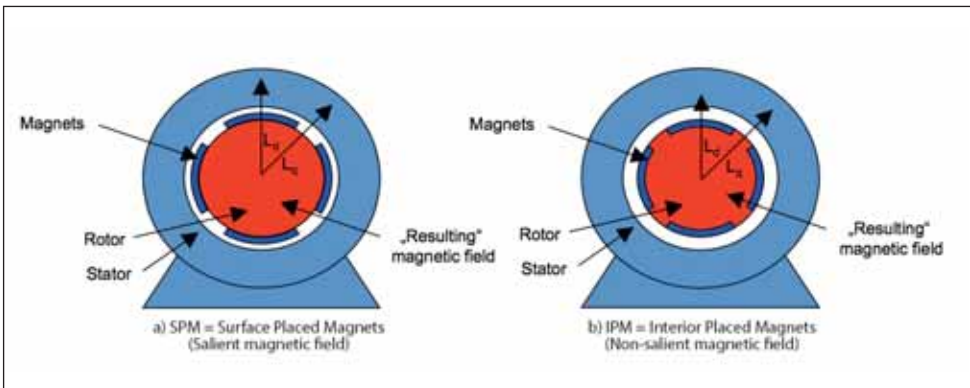

Fig. 1.24 Magnet placement a) SPM and b) IPM

As the magnets behave like air in relation to the resulting magnetic field, salient and non-salient fields are created. With SPM motors L_d and L_q have the same value resulting in a non-salient field while the different L_d and L_q of an IPM creates a salient field which produces an additional torque in field-weakening.

1.4.1.1 Back EMF

When the shaft of a PM motor is turned, the motor produces a voltage at its terminals. This voltage is called back EMF (EMF = electromotive force), and describes an important characteristic of the motor. The higher the voltage, the better the motor efficiency. Depending on the connection and placement of the windings, the shape of the back EMF can be trapezoidal or sinusoidal. For trapezoidal voltage so-called block commutation is required which is easy to realise in the electronics but has drawbacks like noise and torque ripples. Typically PM motors have sinusoidal back EMF and will be operated via sinusoidal commutation.

Given that the motor actively generates a voltage must be considered, not only during operation but also when the feeding FC is disconnected from mains (power loss, breakdown, switched off), because the motor can potentially generate sufficient energy to power up the device while the shaft is rotating (for example, when coasting). The voltage needed for powering the FC depends on the mains voltage the FC is designed for.

Example: Required speed of a PM motor with 200 V back EMF to power on a 400 V mains FC (required DC link voltage approx. 320 V).

$$\eta_{\text{power on}} = \frac{\frac{U_{\text{DC on}}}{\sqrt{2}}}{U_{\text{BackEMF@1000RPM}}} \times 1000 \text{ RPM} = \frac{320\text{V}}{200\text{V}} \times 1000 \text{ RPM} = 1134 \text{ RPM}$$

If the voltage generated by the motor is too high the converter can be destroyed. Practically this can happen when the controlling FC is switched off while the motor is operating at very high speed. During operation the FC limits the voltage coming back from the motor. When the control is suddenly switched off the full back EMF voltage can be seen at the terminals immediately. This critical speed depends on the back EMF of the motor and the voltage the FC is designed for.

Example: 400 V mains, $U_{\text{Back EMF @ 1000 RPM}} = 100 \text{ V}$, $U_{\text{DC critical}} = 1000 \text{ V}$

$$n_{\text{critical}} = \frac{U_{\text{DC critical}}}{U_{\text{BackEMF@1000RPM}} \cdot 2} \times 1000 \text{ RPM} = \frac{1000\text{V}}{100\text{V} \times \sqrt{2}} \times 1000 \text{ RPM} = 5656 \text{ RPM}$$

A brake resistor can be used to overcome such critical situations.

Unfortunately there is no standard used by motor manufacturers to provide information about the back EMF. Some manufacturers state back EMF related to 1000 RPM while others use nominal speed of the motor. Sometimes the value of factor k_e is given in radians and must be converted to RPM.

$$U_{\text{EMF}} = k_e \times \frac{1000}{60} \times 2\pi$$

Where peak values are provided the voltage must be divided by square root of two in order to get the RMS value.

Also advanced motor data like motor resistance and inductances are stated in differing ways. Sometimes they are given as phase/phase values, and sometimes as phase/star values.

$$U_{\text{RMS}} = \frac{U_{\text{Peak}}}{\sqrt{2}}$$

1.4.1.2 Torque and Speed Range

The torque of a PM motor is proportional to the motor current, and its speed is proportional to the feeding frequency. At nominal torque and speed, a certain voltage is required. If the FC can deliver a higher voltage, the speed can be increased further. This results in a higher power at constant torque. When the voltage has reached an upper limit, the motor enters the field weakening area. Operation in field weakening is only possible with suitable frequency converters. Motor mechanics and insulation must support the higher speed and withstand the higher voltage.

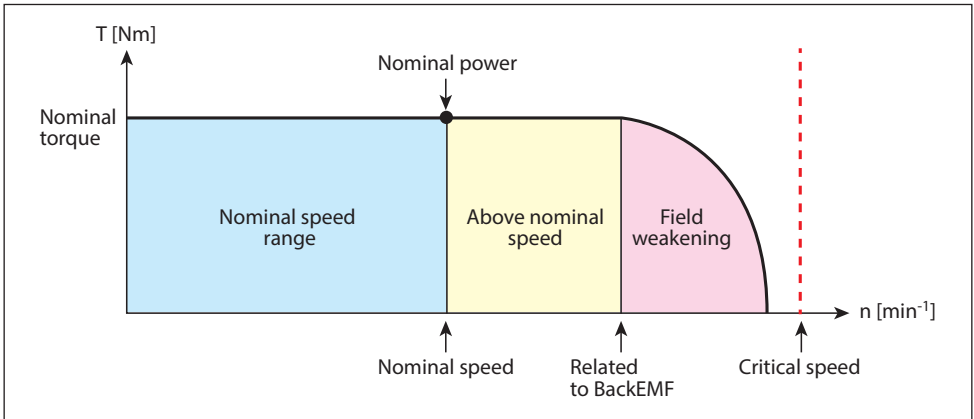

Fig. 1.25 Operation in field weakening area

The greatest risk in field weakening operation is switching off the motor control at too high speed, as the high back EMF can destroy the FC (see section 1.4.1.1 Back EMF).

Another possibility for extending the speed range is to change the star configuration of a motor to delta, if the motor provides this feature. Similar to asynchronous motors, a delta connection results in a higher voltage on the windings, because it is not reduced by the factor $1.73\sqrt{3}$ as for a star configuration.

1.4.2 Brushless DC (BLDC) or Electronically Commutated (EC) Motors

EC (Electronically Commutated Motor) and BLDC (Brushless DC) are basically different names for the same technology. In the original BLDC concept only two phases were energised with a trapezoidal voltage. Compared to a distribution over three phases this result in 1.22 time higher current. For determining the rotor position Hall sensors have been used. Drawbacks of the concept were worse torque ripples and iron losses.

In practice there are many different types of EC motors, such as small servo motors with power ratings of a few watts or motors in building automation systems up to approximately 10 kW. In general BLDC/EC has a reputation for extremely high efficiency. This is fully deserved, in particular for very small devices – the original application area for these motors – where they are distinctly better than universal or split-pole motors (efficiency approximately 30%). Above a few hundred watts the efficiency is comparable to standard PM motors.

Modern EC/ECM utilise the same control principles as the PM motors. In building automation EC motors are often used as hubs in EC fans. This results in a very compact fan unit with a very efficient motor. Unfortunately the placement of the motor in the middle of a centrifugal fan creates air turbulences which reduce the total fan efficiency. In comparison to a direct-driven fan the difference at same motor efficiency can be in the range of 3-6%.

1.4.3 Line Start PM Motor (LSPM motor)

A line start PM motor is a hybrid of a squirrel-cage asynchronous motor and a PM motor where the magnets are placed internally to the rotor.

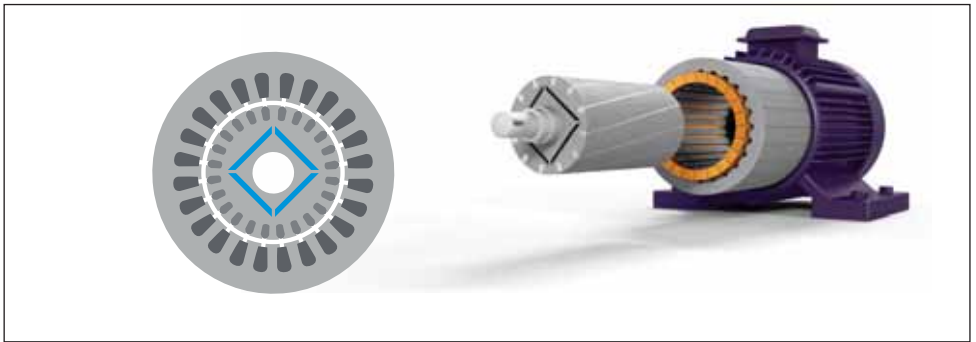

Fig. 1.26 The position of magnets in the rotor influences the motor characteristics

When connected to a three phase grid the motor develops a torque and accelerates like a standard asynchronous motor to near synchronous speed, if the motor torque is greater than the load torque throughout acceleration. When the rotor has roughly reached the speed of the rotating field, a synchronising torque (reaction torque) is produced due to magnetic coupling between the rotating stator field and the rotor poles, which pulls the rotor into synchronism.

After synchronisation, the motor continues to run at synchronous speed. As there is no speed difference between the magnetic field and the rotor, no currents are induced in the cage. This results in a high efficiency with a good power factor. When load changes take place the squirrel cage is still working as a damper. This is also the case when the motor is operated by a FC where the additional damper can reduce the efficiency by approximately 5-10 %.

If the motor is loaded with a torque that is greater than its synchronous stalling torque, it is pulled out of synchronism and continues to operate like an asynchronous motor at a load-dependent speed. Depending on the design, the motor is more or less

sensitive to under-voltage situations which can also result in falling out of synchronism. Renewed synchronisation takes place automatically when the load torque is lower than the synchronising torque. However, the rotor will stop if the motor is loaded with a torque that is greater than its induction stalling torque.

Drawbacks of the concept are the influence of the magnets while starting the motor. Torque oscillations and torque peaks, paired with noise, arise during the start up. Furthermore the starting torque is lower compared to an asynchronous motor as the magnets create a negative torque component (1).

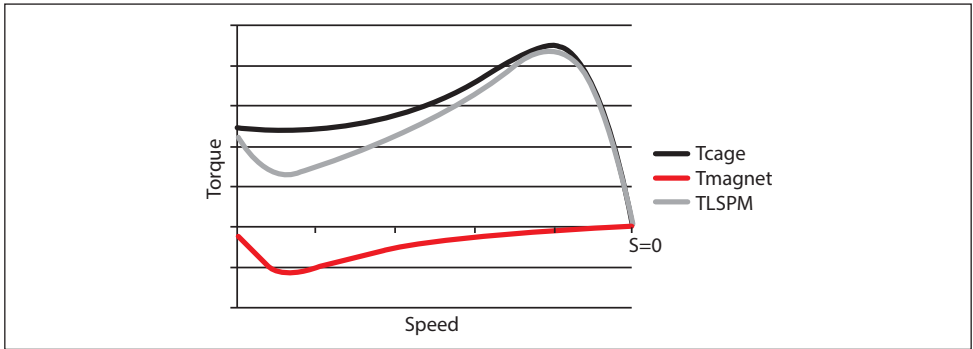

Fig. 1.27 Starting torque of LSMP is reduced compared to the pure squirrel cage torque

LSPM motors are typically used in fans and pumps, available in the power range up to approximately some 10 kW, but can also be used in low inertia applications.

1.4.4 Reluctance Motors

For creating a motor movement these types of motors utilise magnetic reluctance, which is also called magnetic resistance. Similar to electric circuits the magnetic flux follows the path of the lowest resistance. As in asynchronous motors, the magnetic field is created by applying a suitable voltage to the stator windings. The rotor rotates towards the position with minimum magnetic reluctance. If the rotor is now forced out of this position a torque is created in order to move it back to the position where the reluctance is minimised. The torque resulting from the magnetomotive force depends on the relationship between the inductances in the d-axis and q-axis, known as the saliency ratio.

The saliency ratio results directly from the rotor lamination design. Cut-offs in the lamination are utilised to shape the equivalent air gap of the machine by controlling

(1) Source – 2014. J Sorgdrage, A.J Grobler and R-J Wang, Design procedure of a line-start permanent magnet synchronous machine.

the flux paths. They also influence how the d-axis and q-axis inductances vary with the magnetisation current. As these cut-offs increase the equivalent air gap, a higher magnetising current is required which leads to a worse $\cos \varphi$. As illustrated in Fig. 1.28 Maximum power factor vs. saliency ratio, the maximum power factor depends on L_d/L_q ratio. The higher the ratio the better the $\cos \varphi$ becomes. Modern rotor designs have a ratio in the range from 4 to 10.

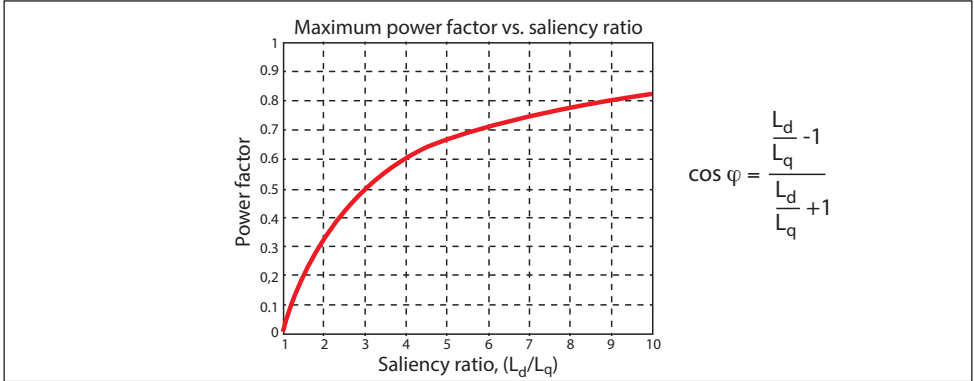

Fig. 1.28 Maximum power factor vs. saliency ratio

Even if reluctance motors require a higher $\cos \varphi$, the energy efficiency is reasonably high. Losses arise in the rotor mainly by harmonics in the air gap between stator and rotor.

The reluctance principle was first used around the year 1840. Over time various optimisations resulted in different motor principles and designs. In the next chapters the three most common types of reluctance machines are described.

1.4.5 Synchronous Reluctance Motor with Squirrel Cage

The stator of this three-phase reluctance motor is identical to that of a standard three-phase squirrel-cage motor. The rotor design is modified by removing the windings and cutting pole gaps on the circumference of the laminated rotor core. The gaps are filled again with aluminium and the end windings are shorted.



Fig. 1.29 Rotor with pole gaps on the circumference placed in the stator

Similar to a LSPM motor design, (see section 1.4.3 Line Start PM Motor (LSPM Motor)) the motor accelerates to near synchronous speed when connected to a three phase grid, if the produced torque is sufficient for the load. When approaching the synchronous speed the rotor is pulled into synchronism and runs at synchronous speed despite the absence of rotor excitation.

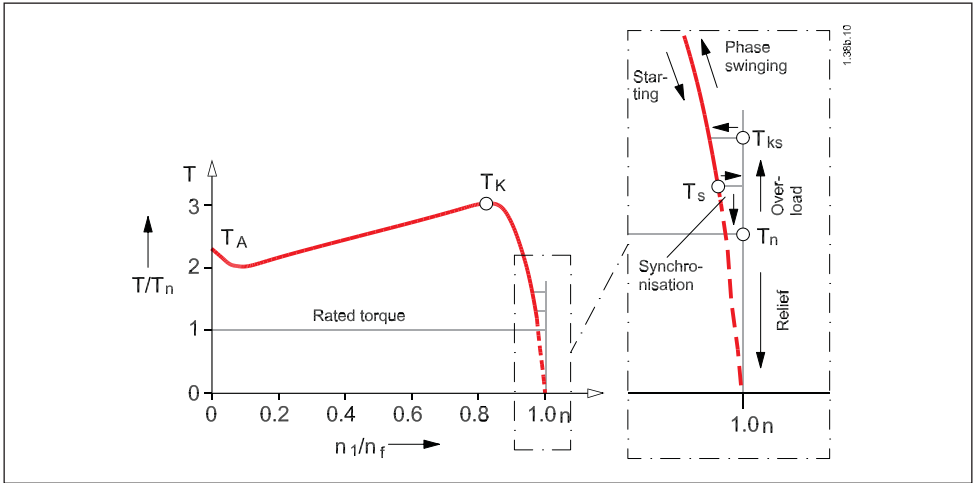

Fig. 1.30 Torque characteristic of a reluctance motor

Under load, the salient rotor poles lag behind the stator rotating field by the load angle. Again the behaviour is similar to LSPM when the load torque becomes too high. The motor is pulled out of synchronism, continues to operate like an asynchronous motor and regains synchronisation automatically when the load torque is lower than the synchronising torque.

The possibility to start direct on line (DOL) and run at synchronous speed make the motor interesting for several applications. Power range ends often at approximately 10 kW. The drawback is a reduced efficiency, especially when operated by FC's, as the rotor windings act as an additional damper.

1.4.6 Synchronous Reluctance Motor (SynRM)

The design of a new generation of reluctance motors focuses on energy efficiency. This highly efficient motor type is often meant when synchronous reluctance motors are addressed and should not be confused with reluctance motors which focus on high torque density or the possibility to start on mains. The key to the efficiency is the new rotor design.



Fig. 1.31 Special rotor lamination design results in high efficiency at low torque ripples

The stator construction and the windings are similar to an asynchronous motor. By applying a suitable voltage to the distributed windings, a harmonic field is created which creates low harmonic losses. Also the design of the rotor is optimised to reduce harmonic losses and operate with low torque ripples.

As the motor cannot start directly on mains, a frequency converter is required to control the motor. For magnetising the cut-offs in the rotor lamination, higher apparent power is required than for an Asynchronous motor (see section 1.4.4 Reluctance Motors). If the converter and the capacitors in the intermediate circuit are suitably sized they will deliver the additional apparent current. In this case the grid is not loaded with the higher apparent power and the low $\cos \varphi$.

For operating the motor, the FC needs to know the rotor angle. Depending on the angle, the converter will energise the different windings. The determination of the rotor angle is often done sensorless without an additional device. In order to achieve an energy efficient control, the converter must also take care of the L_d and L_q behaviour in operation.

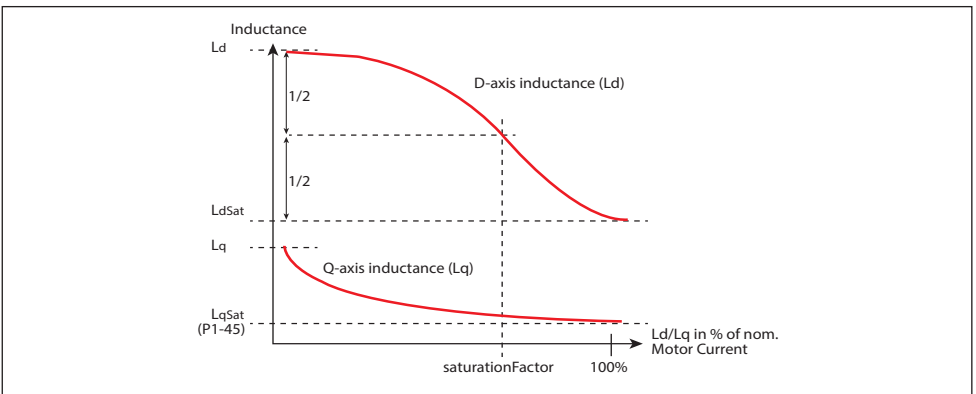

Fig. 1.32 Example of L_d/L_q relationship to I_d/I_q

The inductance components of the SynRM rotor change depending on the load because of saturation effects. Therefore the individual inductances L_d and L_q depend on I_d and I_q current ($L_d(I_d, I_q)$ and $L_q(I_d, I_q)$). If this is taken into account, very high energy efficiency operation of the motor is possible. Over a certain power range the part-load efficiency has advantages against other concepts.

For decades, asynchronous motors were state of the art, while other technologies were only used in niches. The trend towards more energy efficient motors and the opportunities provided by FC's has resulted in innovative technologies like the improved SynRM. More improvements and optimisations are in development.

1.4.7 Switched Reluctance Motor (SRM)

Construction of the stator is very similar to that of DC motors as concentric windings are used. This can result in a compact housing. The rotor lamination design has a very clear shape with low inertia where the number of poles can easily be counted. While on two pole motors the rotor poles are aligned with the stator poles, the pole ratio is typically different. This principle is also applied on other motor types but it is very obvious on switched reluctance motors.

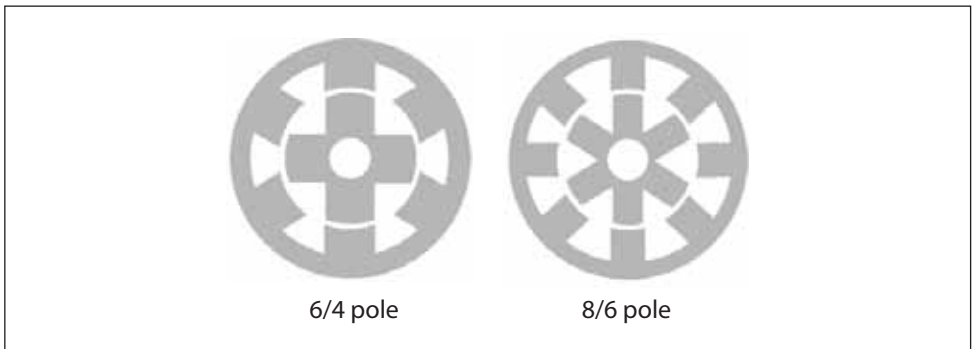

Fig. 1.33 Switched reluctance motor configuration examples

To run the motor a suitable controller is required, which energises the stator coils in a sophisticated way. The phases are energised one after the other. When the coils of a phase are supplied with a voltage, a flux is established through the stator poles and the rotor, which results in rotor movement. After the rotor has started moving the voltage will be switched to the next phase and so on.

Starting the motor directly on mains is not possible. The design allows 100% torque at stall indefinitely and achieves high efficiency even in part-load operation. The double salient construction in rotor and stator is very robust, but results typically in high torque ripples and low dynamics at higher noise.

2 Frequency Converters

Since the late 1960s, the FC has developed at a tremendous rate. Major advances have been made thanks to developments within the fields of microprocessor and semiconductor technology, in particular, and the associated price reduction. However, the basic principles of the FC remain the same.

As stated in the introduction, the main function of a FC is to generate a variable supply (for example, 0 to 400 V / 0 to 50 Hz) from a supply with “fixed” parameters (for example, 400 V and 50 Hz). There are two approaches to performing the conversion, defining two types of FC’s: Direct converters and converters with intermediate circuit.

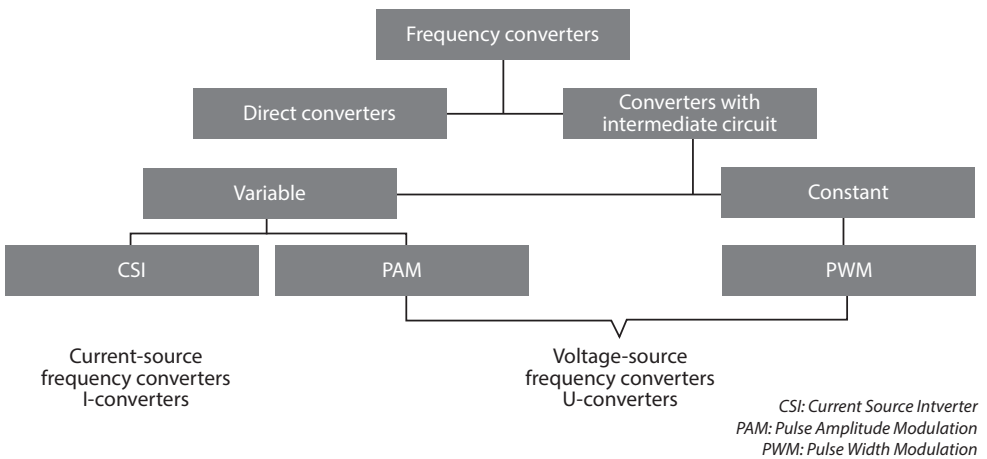

Fig. 2.1 Overview of frequency converter types

2.1 Direct Converters

The direct converter performs the conversion with no intermediate storage.

Direct converters are generally only used in high-power applications (megawatt range). This book does not deal with this type of converter in detail, but several features are worth mentioning. Direct converters are characterised by.

- Reduced frequency control range (approximately 25 to 30 Hz) with 50 Hz mains frequency
- Common use with synchronous motors.
- Suitability for applications with stringent dynamic performance requirements.

2.2 Converters with Intermediate Circuit

In the vast majority of cases, the FC is equipped with an intermediate circuit. Another term for intermediate circuit is "DC bus". Within the category of converters with an intermediate circuit, there are two subtypes:

- constant intermediate circuit
- variable intermediate circuit.

FCs with an intermediate circuit can be broken down into four main components as shown in Fig. 2.2 Block diagram of a frequency converter with an intermediate circuit.

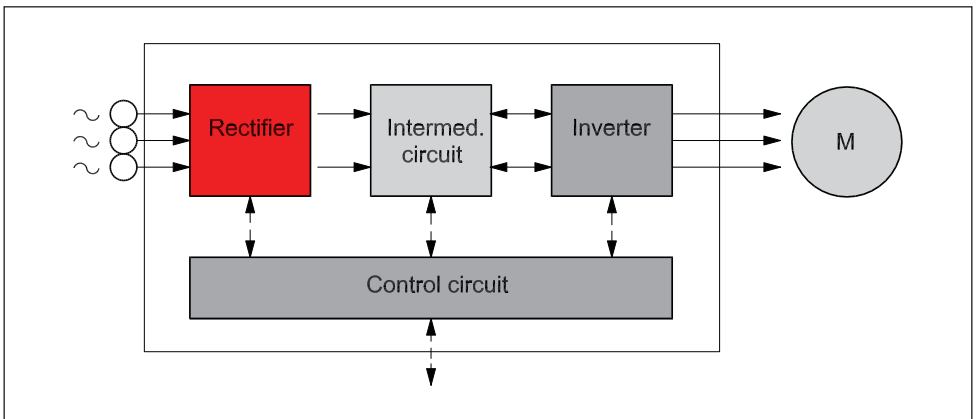

Fig. 2.2. Block diagram of a frequency converter with an intermediate circuit

Rectifier

The rectifier is connected to a single-phase or three-phase AC mains supply and generates a pulsating DC voltage. There are four basic types of rectifier, as shown in Fig. 2.3 Main component topologies Rectifier:

- controlled
- semi-controlled
- uncontrolled
- active front-end

Intermediate circuit

The intermediate circuit can function in three different ways, as shown in Fig. 2.3 Main component topologies Intermediate circuit:

- Conversion of the rectifier voltage into a DC voltage
- Stabilisation or smoothing of the pulsating DC voltage to make it available to the inverter

Inverter

Conversion of the constant DC voltage of the rectifier into a variable AC voltage. The inverter generates the frequency of the motor voltage. Alternatively, some inverters may additionally convert the constant DC voltage into a variable AC voltage. See Fig. 2.3 Main component topologies Inverter.

Control circuit

The control circuit transmits signals to – and receives signals from – the rectifier, the intermediate circuit and the inverter. The design of the individual FC determines specifically which parts are controlled.

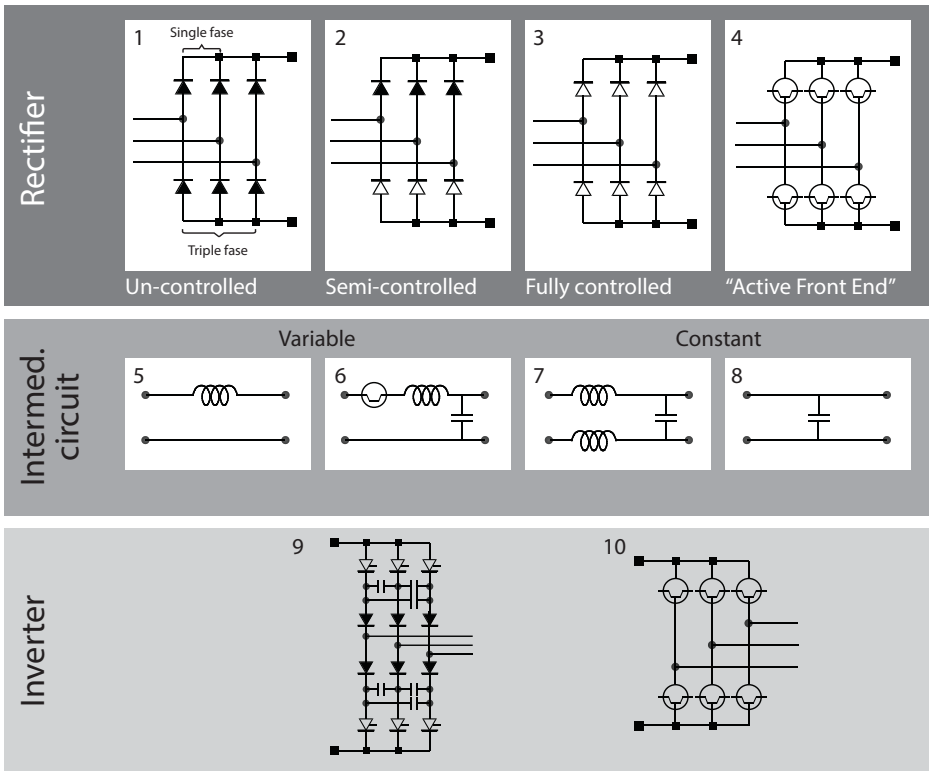

Fig. 2.3 Main component topologies

Configuration of the FC involves selection between different main components. See table 2.1 Frequency converter configuration examples.

Configuration example	Abbreviation	Configuration: Reference to components in Fig. 2.3
Pulse amplitude modulated converter	PAM	1 or 2 or 3 and 6 and 9 or 10
Pulse width modulated converter	PWM	1 or 2 or 3 or 4 and 7 or 8 and 9 or 19
Current-source converter	CSI	3, 5, and 9

Table 2.1 Frequency converter configuration examples

What all FC's have in common is that the control circuit uses signals to switch the inverter semiconductors on and off. This switching pattern is based on a variety of principles. FC's can further be broken down into types according to the switching pattern that controls the supply voltage to the motor.

2.3 Rectifier

Depending on the power involved, the power supply takes the form of a three-phase AC voltage or a single-phase AC voltage with a fixed frequency.

For example:

Three-phase AC voltage: 3 x 400 V/50 Hz

Single-phase AC voltage: 1 x 240 V/50 Hz

The rectifier of a FC consists of diodes or thyristors, a combination of both, or bipolar transistors (IGBTs).

Fig. 2.3 Main component topologies shows the four different rectification approaches that are available today. In low-power applications (up to 30 kW, depending on the manufacturer), uncontrolled B6 bridge rectifiers are generally used. Half-controlled rectifiers are used in the power range 37 kW and above.

The rectifier circuits described above allow energy to flow in one direction, from the supply to the intermediate circuit.

2.3.1 Uncontrolled rectifiers

Uncontrolled rectifiers consist of diodes as shown in Fig. 2.4 How diodes work.

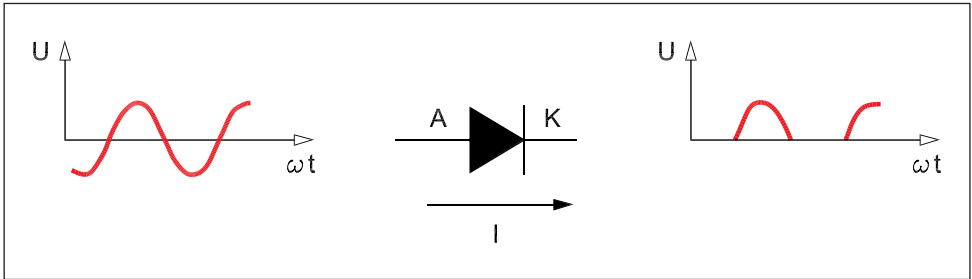

Fig. 2.4 How diodes work

A diode allows current to flow in one direction only: from the anode (A) to the cathode (K). The current is blocked if it attempts to flow from the cathode to the anode. It is not possible to control the current strength, as is the case with some other semiconductors. An AC voltage across a diode is converted into a pulsating DC voltage. If a three-phase AC voltage is supplied to an uncontrolled three-phase rectifier, the DC voltage will pulsate continuously.

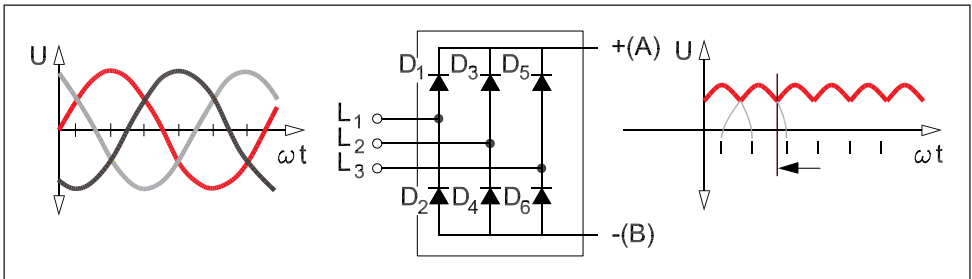

Fig. 2.5 Uncontrolled rectifier (B6-diode bridge)

Fig. 2.5 Uncontrolled rectifier (B6-diode bridge) shows an uncontrolled three-phase rectifier consisting of two groups of diodes. One group consists of diodes D_1 , D_3 and D_5 . The other group consists of diodes D_4 , D_6 and D_2 . Each diode conducts for one-third of the period T (120°).

In both groups, the diodes conduct in sequence. Periods during which both groups conduct are offset in relation to each other by one sixth of the period T (60°). Diode group $D_{1,3,5}$ conducts the positive voltage. When the voltage of phase L_1 reaches the positive peak value, terminal (A) takes on the value of phase L_1 . Reverse voltages of the magnitude U_{L1-2} and U_{L1-3} are present across the other two diodes.

The same principle applies to diode group $D_{4,6,2}$. Here terminal (B) takes on the negative phase voltage. If, at a given time, L_3 reaches the negative threshold value, diode D_6 conducts.

The other two diodes are subject to reverse voltages of the magnitude U_{L3-1} and U_{L3-2} .

The DC output voltage of the uncontrolled rectifier is constant and represents the difference between the voltages of the two diode groups. The average value of the pulsating DC voltage is approximately 1.31 to 1.41 times the mains voltage with a three-phase supply or approximately 0.9 to 1.2 times the AC voltage in the case of a single-phase supply.

The current consumption of the diodes is not sinusoidal. Consequently, uncontrolled rectifiers generate mains interference. To counteract this, FCs with B12 and B18 rectifiers are increasingly used. B12 and B18 rectifiers comprise 12 or 18 diodes respectively, organised in groups of 6.

2.3.2 Semi-controlled Rectifiers

In the case of semi-controlled rectifiers, a thyristor group takes the place of one of the diode groups (for example, $D_{4,6,2}$ as shown in Fig. 2.5 – Uncontrolled rectifier (B6-diode bridge). The thyristors are also referred to as silicon controlled rectifiers (SCR). SCRs are found in many applications in electronics, and in particular for power control.

By controlling the firing times of the thyristors, it is possible to limit the inrush current of the units and achieve soft-charging of the capacitors in the intermediate circuit. The output voltage of these rectifiers is identical to that produced by uncontrolled rectifiers. Typically, semi-controlled rectifiers are found in FCs of power size 37 kW and greater.

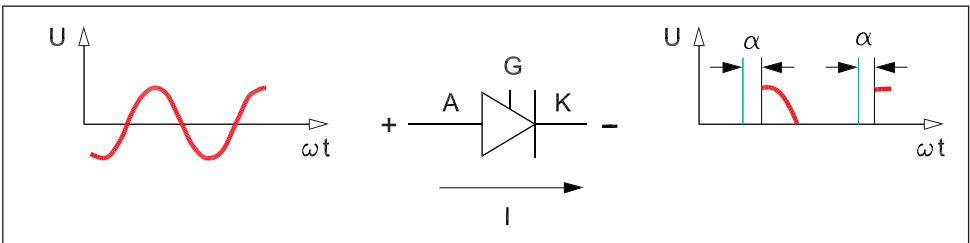

Fig. 2.6 How thyristors work

Referring to Fig. 2.6 How thyristors work, when α is between 0° and 90° , the thyristor circuit is used as a rectifier. When the α value is between 90° and 300° the thyristor circuit is used as an inverter.

2.3.3 Fully-controlled Rectifiers

Fully-controlled rectifiers involve the use of thyristors. As with a diode, a thyristor permits the current to flow from the anode (A) to the cathode (K) only. However, the difference is that the thyristor has a third terminal known as the gate (G). When the gate is triggered by a signal, the thyristor will conduct. Once current starts flowing through the thyristor, it will continue conducting until the current drops to zero. The current cannot be interrupted by sending a signal to the gate.

Thyristors are used in rectifiers. The signal sent to the gate is known as the α control signal of the thyristor. α is a time delay, which is specified in degrees. The degree value indicates the delay between the voltage zero crossing and the time when the thyristor is triggered.

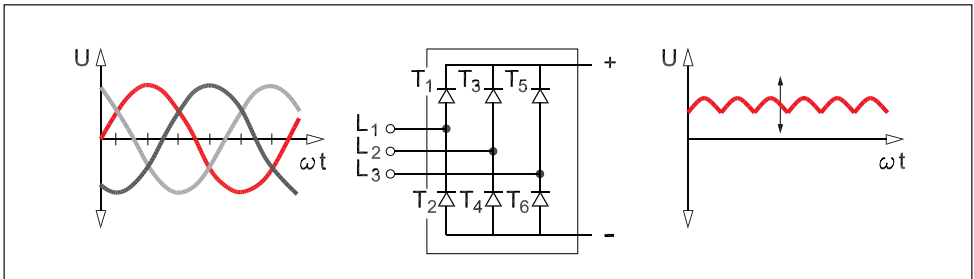

Fig. 2.7 Fully-controlled three-phase rectifier

Fully-controlled three-phase rectifiers can be broken down into two groups of thyristors: T1, T3 and T5, on the one hand, and T4, T6 and T2 on the other. With fully controlled rectifiers, α is calculated from the moment when the corresponding diode in an uncontrolled rectifier would normally begin to conduct, that is, 30° after the voltage zero crossing. In all other respects, controlled rectifiers behave like uncontrolled rectifiers.

The amplitude of the rectified voltage can be varied by controlling α . Fully-controlled rectifiers supply a DC voltage with an average value U , where $U = 1.35 \times \text{mains voltage} \times \cos \alpha$.

Compared to uncontrolled rectifiers, fully-controlled rectifiers result in major losses and disturbances in the supply network, because they draw a high reactive current when the thyristors conduct for short periods. This is one of the reasons why thyristors are mainly used in the inverter section of the FC. However, the advantage of fully-controlled rectifiers is that they enable regenerative braking power in the intermediate circuit to be fed back to the supply network.

2.3.4 Active Front-End / Active Infeed

For certain FC applications the motor sometimes works as a generator. In these cases the energy balance can be improved by returning energy to the supply grid.

Such FC's require a controlled (active) rectifier, which allows energy to flow backwards. Therefore these devices are called Active Front End (AFE) or Active Infeed Converters (AIC). Precondition for feeding back energy to the supply grid is that the voltage level in the intermediate circuit is higher than the grid voltage. This higher voltage must be maintained in all operating conditions. Various strategies are available to reduce the losses during standby and motor operation but none can completely eliminate losses. Further additional filtering is required in generative mode as the generated voltage does not fit the sine wave shape of the supply grid without.

2.4 Intermediate Circuit

Depending on the design, the functions performed by the intermediate circuit include:

- Acting as an energy buffer so that the motor can draw energy from/return energy to the grid via the inverter and as a means of accommodating intermittent load surges
- Decoupling the rectifier from the inverter
- Reducing mains interference

The intermediate circuit is based on one of four different basic circuits, shown in Fig. 2.3 Main component topologies. The type of intermediate circuit used is determined by the nature of the rectifier and inverter with which it is to be combined.

The basic differences between the various types of intermediate circuit are explained in the following sections.

2.4.1 Variable Intermediate Circuit

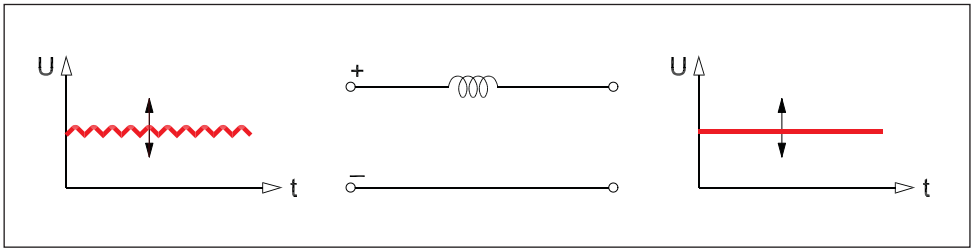

Fig. 2.8 Variable DC intermediate circuit

This type of intermediate circuit consists of a very large inductor, also known as a “choke”, and is combined with a fully controlled rectifier as shown in Fig. 2.3 Main component topologies part 5, and Fig. 2.8 Variable DC intermediate circuit.

The inductor converts the variable voltage from the fully controlled rectifier into a variable direct current. The load determines the size of the motor voltage. The advantage of this kind of intermediate circuit is that braking energy from the motor can be fed back into the supply network without the need for additional components. The inductor is used in current-source FCs (I-converters).

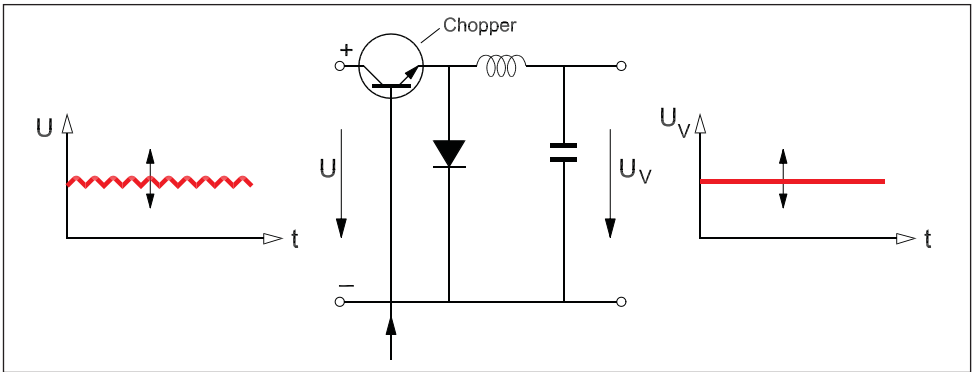

Fig. 2.9 Variable DC voltage intermediate circuit

Finally, a chopper can be inserted in front of a filter, as shown in Fig. 2.9 Variable DC voltage intermediate circuit. The chopper contains a transistor which acts as a switch for turning the rectified voltage on and off. The control circuit regulates the chopper by comparing the variable voltage after the filter (U_V) with the input signal.

If there is a difference between these values, then the ratio of the time t_{on} (when the transistor is conducting) to the time t_{off} (when the transistor is blocking) is adjusted.

This makes it possible to vary the effective value of the DC voltage depending on how long the transistor conducts. This can be expressed as:

$$U_V = U \times \frac{t_{\text{off}}}{t_{\text{on}} + t_{\text{off}}}$$

When the chopper transistor interrupts the current, the filter inductor (or “choke”) attempts to produce an infinitely high voltage across the transistor. To prevent this from happening, the chopper is protected by a freewheeling diode, as shown in Fig. 2.9 Variable DC voltage intermediate circuit.

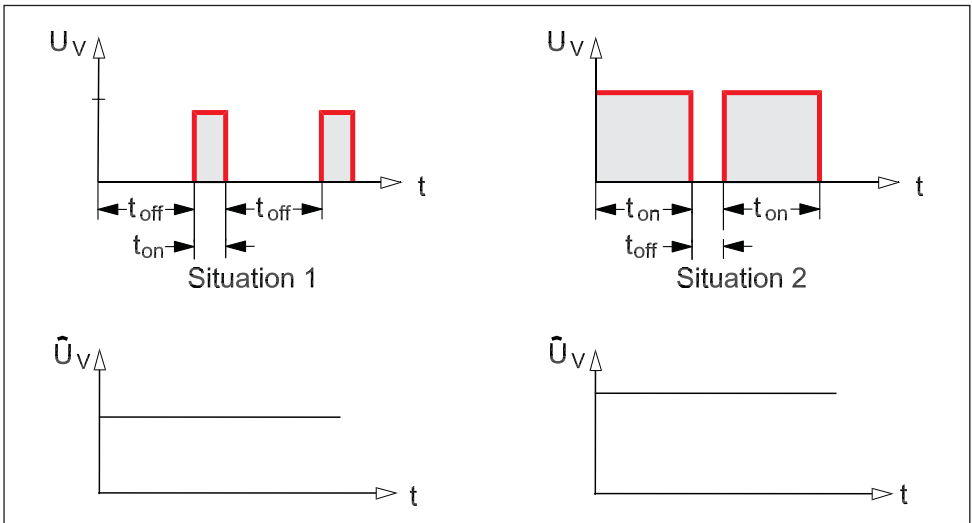

Fig. 2.10 Chopper transistor regulates the intermediate circuit voltage with corresponding effective value

The filter in the intermediate circuit smooths the square-wave voltage after the chopper, while keeping the voltage constant at a given frequency. The frequency associated with the voltage is generated in the inverter.

2.4.2 Constant Intermediate Circuit

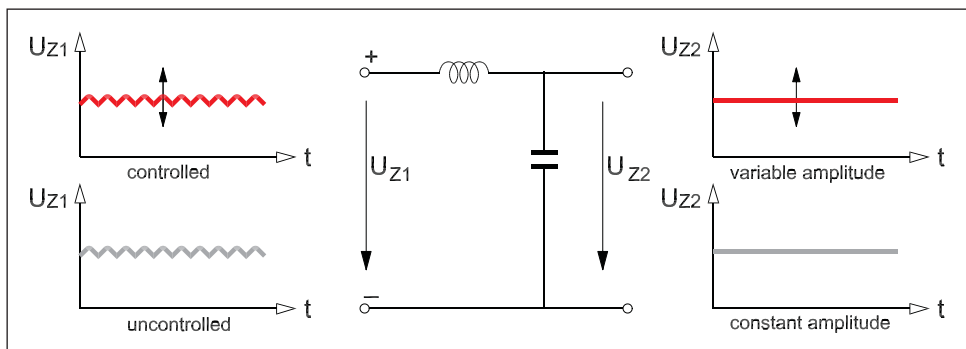

Fig. 2.11 Constant DC intermediate circuit

The intermediate circuit can consist of a filter comprising a capacitor and/or an inductor (choke). Typically, electrolytic capacitors are used due to their high energy density. Although capacitors have a limited service life, they offer the following benefits:

- Smoothing of pulsating DC voltage (U_{Z1})
- Availability as an energy reserve for supply voltage drops
- Availability for energy storage for load surges and generative operation of the motor

DC inductors offer the following advantages

- The FC is protected against mains transients
- Smoothing of current ripple, which in turn increases the service life of the intermediate circuit components, especially the capacitors
- Reduction of mains interference and the option of smaller supply conductor cross sections. This function can also be implemented by means of line chokes upstream of the FC

When planning an installation it is important to note that the inductors are heavy and can get hot. Hot spots can arise.

This form of intermediate circuit can be combined with various types of rectifier. In the case of fully controlled rectifiers, the voltage is kept constant at a given frequency. Thus, the voltage that is supplied to the inverter is a pure DC voltage (U_{Z2}) with variable amplitude.

With semi-controlled or uncontrolled rectifiers, the voltage at the inverter input is a DC voltage with constant amplitude (approximately $\sqrt{2}$ times the mains voltage). The anticipated voltage and frequency are both generated in the inverter.

In the last few years manufacturers have devised intermediate circuits without capacitors and inductors (chokes). This has been generally termed “capacitor less” or “slim” intermediate circuit. The control circuit controls the rectification of the supply voltage in a way that lower inrush currents can be achieved and so that mains interference can be limited to values of less than 40% (fifth harmonic). This results in the following characteristics:

- Lower building cost
- No charging circuit required
- More compact and lower weight construction
- Susceptibility to supply system voltage dips. That is, the FC is more likely to trip in the event of voltage dips, due to transients in the supply system
- Mains interference can occur in the high frequency spectrum
- The high ripple associated with the intermediate circuit reduces the output voltage by approximately 10% and results in higher motor power consumption
- The restart time for operation may be longer, due to three processes occurring:
 - Re-initialisation of the FC
 - Magnetisation of the motor
 - Ramping up to the required reference for the application

2.5 Inverter

The inverter is the last of the main elements making up the FC. The inverter processes represent the final stage in terms of generating the output voltage and frequency. When the motor is connected directly to the mains, the ideal operating conditions apply at the rated operating point.

The FC guarantees good operating conditions throughout the whole speed range by adapting the output voltage to the load conditions. It is thus possible to maintain the magnetisation of the motor at the optimal value.

From the intermediate circuit, the inverter obtains one of the following:

- Variable direct current
- Variable DC voltage
- Constant DC voltage

In each case, the inverter must ensure that the supply to the motor is an AC voltage. In other words, the frequency of the motor voltage must be generated in the inverter. The inverter control method depends on whether it receives a variable or a constant value. With a variable current or voltage, the inverter only needs to generate the

corresponding frequency. With a constant voltage, the inverter generates both the frequency and amplitude of the voltage.

Even though inverters work in different ways, the basic design is always the same. The main components are controlled semiconductors, arranged in pairs in three branches, as shown in Fig. 2.3 Main component topologies.

Transistors are increasingly taking the place of thyristors in the inverter stage of FCs for several good reasons. Firstly, transistors are now available for large currents, high voltages and high switching frequencies. Furthermore, unlike thyristors and diodes, transistors are not affected by the current zero crossing. Transistors can enter the conducting or blocking state at any time simply by changing the polarity of the voltage applied to the control terminals. The advances made in the field of semiconductor technology over recent years have increased the switching frequency of transistors significantly. The upper switching limit is now several hundred kHz.

Thus, magnetic interference caused by pulse magnetisation within the motor can be avoided. Another advantage of the high switching frequency is the fact that it allows variable modulation of the FC output voltage. This means that a sinusoidal motor current can be achieved, as shown in Fig. 2.12 Effect of switching frequency on motor current. The control circuit of the FC merely has to switch the inverter transistors on and off in accordance with a suitable pattern.

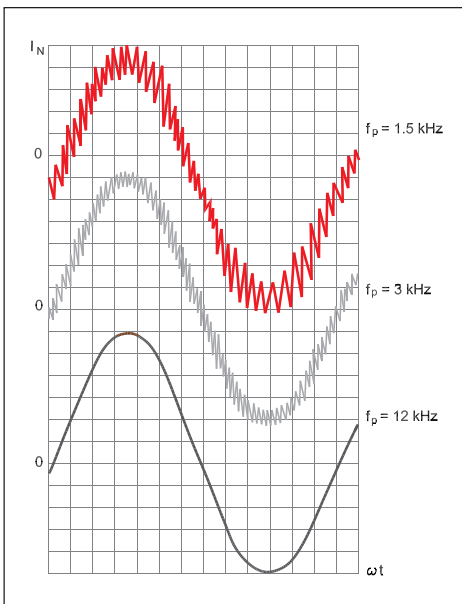

Fig. 2.12 Effect of switching frequency on motor current

The choice of the inverter switching frequency is a trade-off between losses in the motor (sine shape of motor current) and losses in the inverter. As the switching frequency increases, so do the losses in the inverter, in line with the number of semiconductor circuits.

High-frequency transistors can be divided into three main types:

- Bipolar (LTR)
- Unipolar (MOSFET)
- Insulated Gate Bipolar (IGBT)

Table 2.2 Comparison of power transistor characteristics shows the key differences between MOSFET, IGBT and LTR transistors.

Properties	Semi-conductor		
	MOSFET	IGBT	LTR
Symbol			
Design			
Conductivity Current conductivity Losses	Low High	High Insignificant	High Insignificant
Blocking conditions Upper limit	Low	High	Medium
Switching conditions Turn-on time Turn-off time Losses	Short Short Insignificant	Medium Medium Medium	Medium Low High
Control conditions Power Driver	Medium Voltage	Medium Voltage	High Current

Table 2.2 Comparison of power transistor characteristics.

IGBT transistors are a good choice for FCs in terms of the power range, the high level of conductivity, the high switching frequency and ease of control. They combine the features of MOSFET transistors with the output properties of bipolar transistors. The actual switching components and inverter control are normally combined to create a single module called an “intelligent power module” (IPM).

A freewheeling diode is connected in parallel with each transistor, because high induced voltages can occur across the inductive output load. The diodes force the motor currents to continue flowing in their direction and protect the switching components against imposed voltages. The reactive power required by the motor is also handled by the freewheeling diodes.

2.6 Modulation Principles

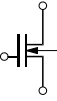
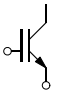
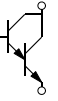
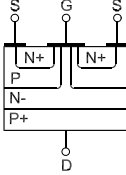
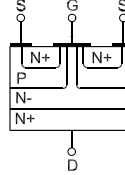
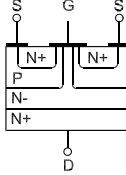
The semiconductors in the inverter either conduct or block according to the signals generated by the control circuit. The variable voltages and frequencies are generated using two basic principles (types of modulation):

- Pulse Amplitude Modulation (PAM) and
- Pulse Width Modulation (PWM)

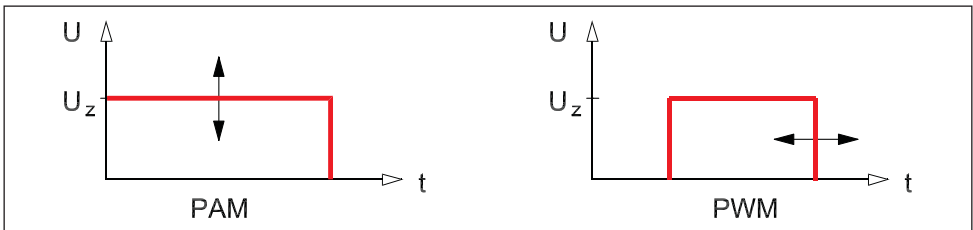

Fig. 2.13 Modulation of amplitude and pulse width

2.6.1. Pulse Amplitude Modulation (PAM)

PAM is used in FC's with variable intermediate circuit voltage or current. In FC's with uncontrolled or half-controlled rectifiers, the amplitude of the output voltage is generated by the intermediate circuit chopper, shown in Fig. 2.9 Variable DC voltage intermediate circuit. In a case where the rectifier is fully controlled, the amplitude is generated directly. This means that the output voltage for the motor is made available in the intermediate circuit.

The intervals during which the individual semiconductors should be on or off are stored in a pattern, and this pattern is read out at a rate dependent on the desired output frequency.

This semiconductor switching pattern is controlled by the magnitude of the intermediate circuit variable voltage or current. If a voltage-controlled oscillator is used, the frequency always follows the amplitude of the voltage.

Using PAM can result in lower motor noise and very minor efficiency advantages in special applications like high speed motors (10.000 – 100.000 RPM). However, this often does not overrule the drawbacks like higher costs for the more sophisticated hardware and control issues like higher torque ripples at low speed.

2.6.2 Pulse width Modulation (PWM)

PWM is used in FC's with constant intermediate circuit voltage. This is the most widely-established and best developed method. Compared with PAM, the hardware requirements for this modulation method are lower, control performance at low speed is better and brake resistor operation is always possible. Some manufacturers dispense with electrolytic capacitors and inductors (chokes) (slim intermediate circuit).

The motor voltage can be varied by applying the intermediate circuit (DC) voltage to the motor windings for a certain length of time. The frequency can be varied by shifting the positive and negative voltage pulses for the two half periods along the time axis.

Because the technology varies the width of the voltage pulses, it is called "Pulse Width Modulation" or PWM. With conventional PWM techniques, the control circuit determines the on and off times of the semiconductors in a way which makes the motor voltage waveform as sinusoidal as possible. Thus the losses in the motor winding can be reduced and a smooth motor operation, even at low speed is achieved.

The output frequency is varied by connecting the motor to half the intermediate circuit voltage for a specific period of time. The output voltage is varied by dividing the voltage pulses of the FC output terminals into a series of narrower individual pulses with pauses in between. The pulse-to-pause ratio can be modified depending on the required voltage level. This means that the amplitude of the negative and positive voltage pulses always corresponds to half the intermediate circuit voltage.

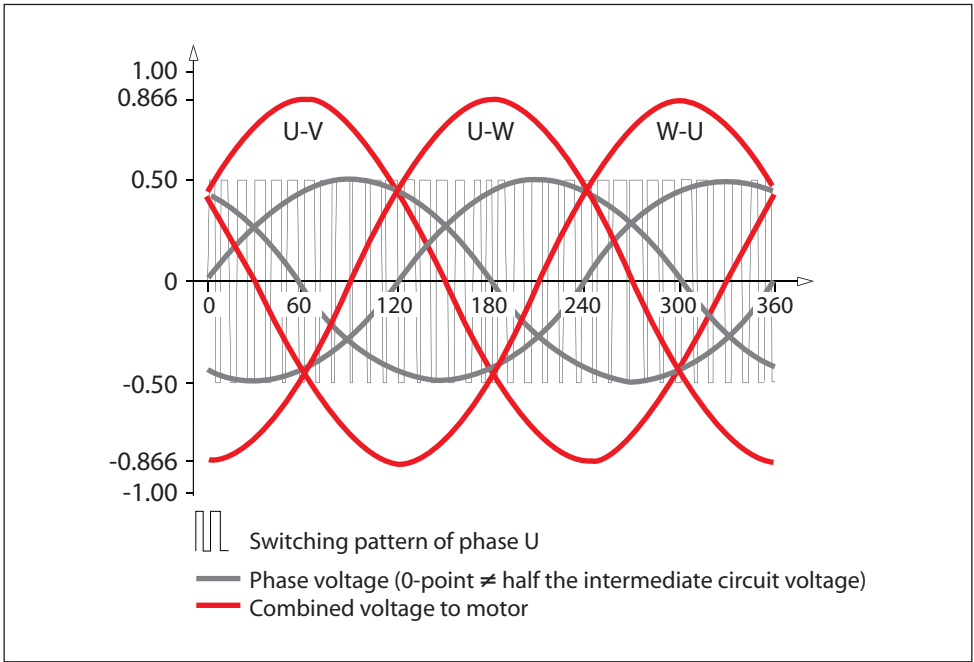

Fig. 2.14 Output voltage PWM

Low stator frequencies result in longer periods. The period can increase to such an extent that it is no longer possible to maintain the frequency of the triangular waveform.

This makes the voltage-free period too long, causing the motor to run irregularly. To prevent this, the frequency of the triangular waveform can be doubled at low frequencies.

The low switching frequency leads to an increase in acoustic motor noise. To limit the amount of noise produced, the switching frequency can be increased. This has been made possible thanks to advances in the field of semiconductor technology, which mean that modulation of an approximately sinusoidal output voltage and generation of an approximately sinusoidal current are now achievable. A PWM FC that relies exclusively on sinusoidal reference modulation can provide up to 86.6% of the rated voltage (see Fig. 2.14 Output voltage PWM).

The phase voltage at the FC output terminals corresponds to half the intermediate circuit voltage divided by $\sqrt{2}$, and is thus equal to half the mains supply voltage. The mains voltage of the output terminals is equal to $\sqrt{3}$ times the phase voltage and is thus equal to 0.866 times the mains supply voltage.

The output voltage of the FC cannot equal the motor voltage if full sinusoidal wave form is needed, as the output voltage would be roughly 13 % too low. However, the extra voltage needed can be obtained by reducing the number of pulses when the frequency exceeds approximately 45 Hz. The disadvantage of using this method is that it makes the voltage alternate step-wise and the motor current becomes unstable. If the number of pulses is reduced, the harmonic content at the FC output increases. This results in higher losses in the motor.

Another way of dealing with the problem involves using other reference voltages instead of the three sine references. These voltages could have any shape of waveform, for example, trapezoidal or step-shaped.

For example, one common reference voltage uses the third harmonic of the sine reference. By increasing the amplitude of the sine reference by 15.5 % and adding the third harmonic, a switching pattern for the inverter semiconductors can be obtained which increases the output voltage of the FC. All control values of the inverter are transmitted from the control card, and the various reference signals for determining the switching times are stored in a table in memory and are then read out and processed according to the reference value.

There are other ways of determining and optimising the on and off switching times of the semiconductors. The Danfoss VVC and VVCplus control principles are based on microprocessor calculations which identify the optimum switching times for the inverter semiconductors.

The specifications for the software involved in calculating the switching times are manufacturer-specific and will not be covered here.

If more stringent requirements are imposed on the FC speed setting range and smooth running characteristics, then the PWM switching times need to be determined by an additional digital IC rather than the microprocessor. For example, an ASIC (Application Specific Integrated Circuit) can determine the PWM switching times. This component incorporates the manufacturer's proven knowledge. Meanwhile, the microprocessors are responsible for handling other control tasks.

2.6.3 Asynchronous PWM

Two asynchronous PWM methods are described below:

- SFAVM (Stator Flux-oriented Asynchronous Vector Modulation)
- 60° AVM (Asynchronous Vector Modulation)

These enable the amplitude and angle of the inverter voltage to be changed in steps.

2.6.3.1 SFAVM

Stator Flux-oriented Asynchronous Vector Modulation (SFAVM) is a space-vector modulation method that makes it possible to change the inverter voltage arbitrarily, but step-wise within the switching time (in other words, asynchronously). The main purpose of this type of modulation is to maintain the stator flux at the optimum level throughout the stator voltage range, ensuring no torque ripple. Compared with the mains supply, a “standard” PWM supply will result in deviations in the stator flux vector amplitude and the flux angle. These deviations will affect the rotating field (torque) in the motor air gap and will cause torque ripple. The effect produced by the deviation in amplitude is negligible and can be reduced by increasing the switching frequency. The deviation in the angle depends on the switching sequence and can result in higher levels of torque ripple. Consequently, the switching sequence must be calculated in such a way as to minimise the deviation in the vector angle.

Each inverter branch of a 3-phase PWM inverter can assume two switch states, ON or OFF, as shown in Fig. 2.15 Inverter switch states. The three switches result in eight possible switch combinations, leading in turn to eight discrete voltage vectors at the inverter output or at the stator winding of the connected motor. As shown below, these vectors (100, 110, 010, 011, 001, 101) mark the corners of a hexagon, where 000 and 111 are zero vectors.

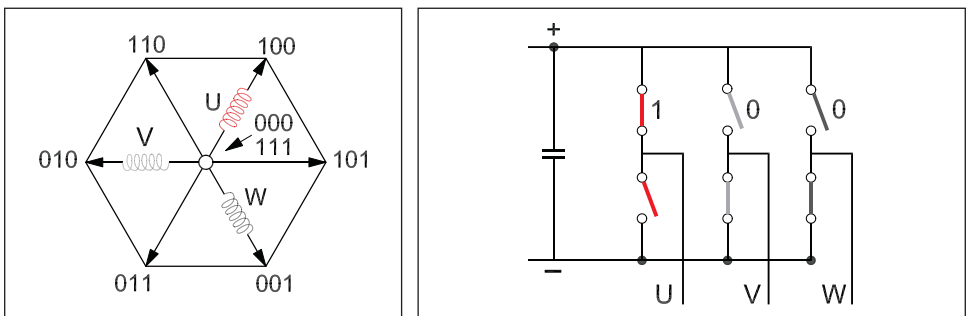

Fig. 2.15 Inverter switch states

With switch combinations 000 and 111, the same potential occurs at all three output terminals of the inverter. This will be either the positive or negative potential from the intermediate circuit, as shown in Fig. 2.15 Inverter switch states. As far as the motor is concerned, this is the equivalent to a terminal short circuit and so a voltage of 0 V is applied to the motor windings.

Generation of motor voltage

Steady-state operation involves controlling the machine voltage vector $U_{\omega t}$ on a circular path. The length of the voltage vector is a measure of the value of the motor voltage and the speed of rotation, and corresponds to the operating frequency at a specific time. The motor voltage is generated by briefly pulsing adjacent vectors to produce an average value.

Some of the features of the Danfoss SFAVM method are as follows:

- The amplitude and angle of the voltage vector can be controlled in relation to the preset reference without deviations occurring
- The starting point for a switching sequence is always 000 or 111. This enables each voltage vector generated to have three switch states
- The voltage vector is averaged by means of short pulses on adjacent vectors as well as the zero vectors 000 and 111

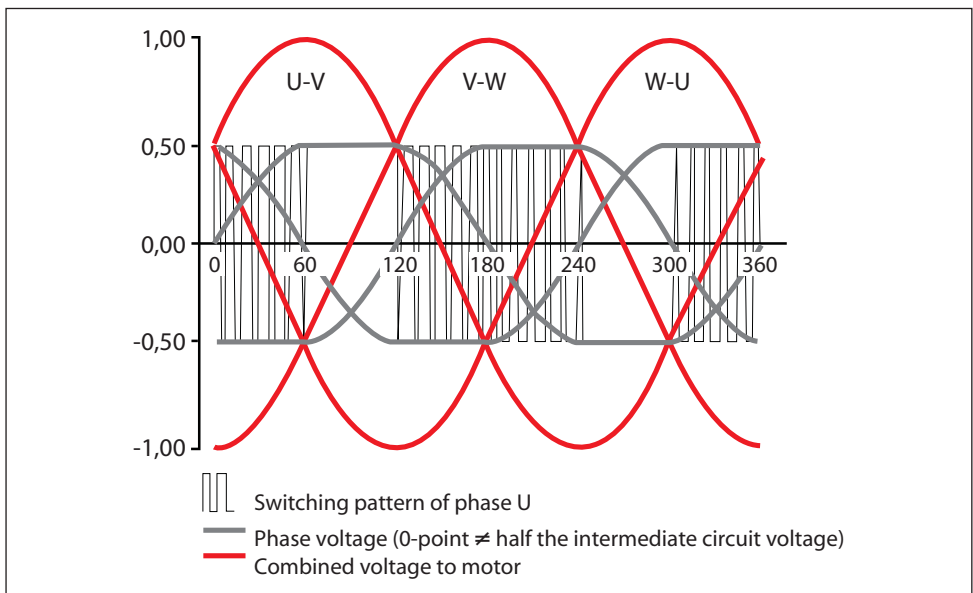

Fig. 2.16 With the synchronous 60° PWM principle the full output voltage is obtained directly

SFAVM provides a link between the control system and the power circuit of the inverter. The modulation is synchronous to the control frequency of the controller and asynchronous to the fundamental frequency of the motor voltage. Synchronisation between control and modulation is an advantage for high- power control (for example, voltage vector, or flux vector control), since the control system can control the voltage vector directly and without limitations. Amplitude, angle and angular speed are controllable.

In order to dramatically reduce the on-line calculation time, the voltage values for different angles are listed in a table. Fig. 2.17 Output voltage (motor) – (phase-phase) shows the motor voltage at full speed.

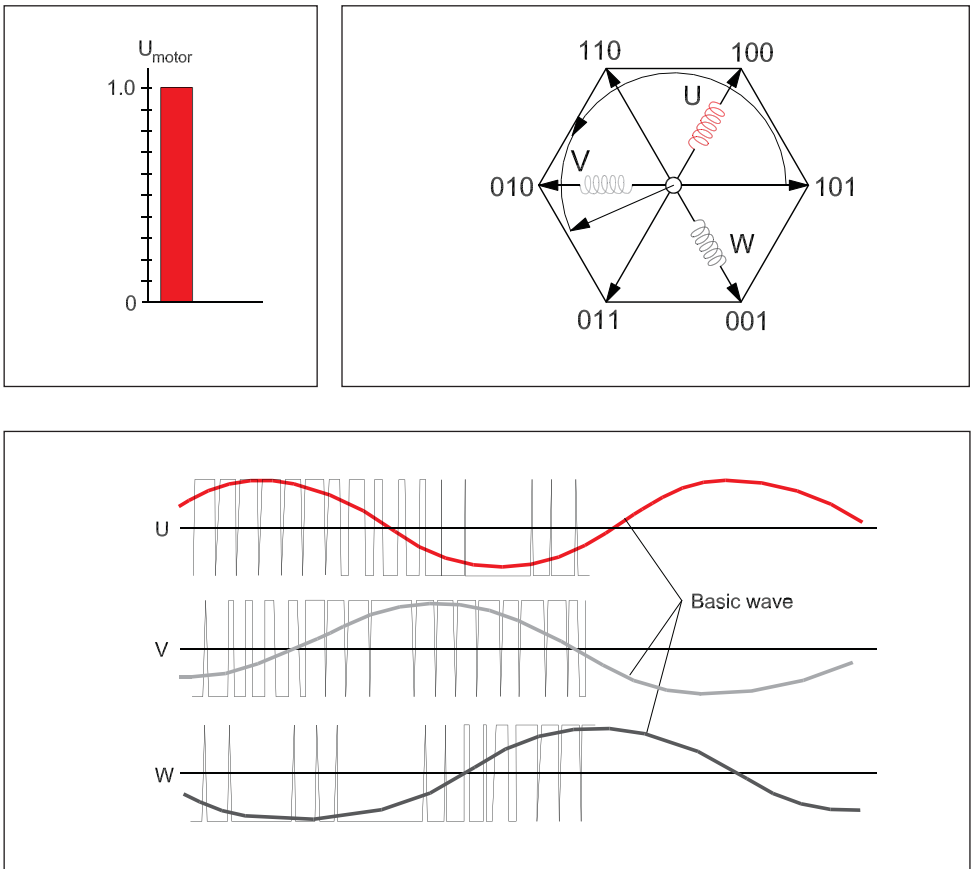

Fig. 2.17 Output voltage (motor) – (phase-phase).

2.6.3.2 60° AVM

If 60° AVM (Asynchronous Vector Modulation) is used – as opposed to the SFAVM principle – the voltage vectors are determined as follows:

- Within one switching period, only one zero vector (000 or 111) is used
- A zero vector (000 or 111) is not always used as the starting point for a switching sequence
- One phase of the inverter is held constant for 1/6 of the period (60°). The switch state (0 or 1) remains the same during this interval. In the two other phases, switching is performed in the normal way

Fig. 2.18 Switching sequence of the 60° AVM and SFAVM methods for a number of 60° intervals and Fig. 2.19 Switching sequence of the 60° AVM and SFAVM methods for several periods compare the switching sequence of the 60° AVM method with that of the SFAVM method – for a short interval (Fig. 2.18) and for several periods (Fig. 2.19).

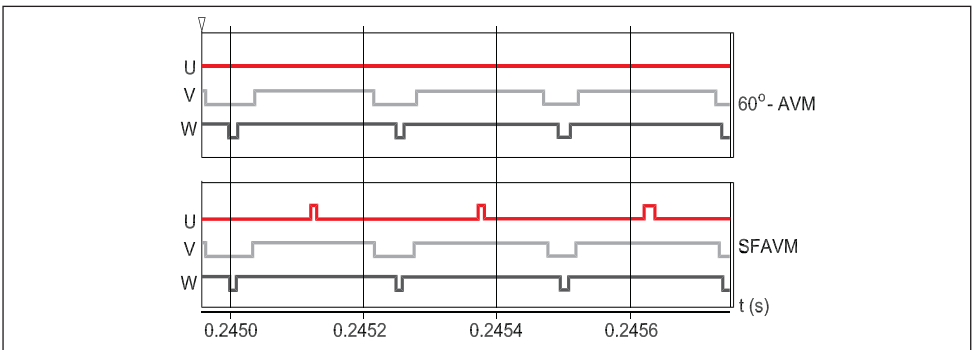

Fig. 2.18 Switching sequence of the 60° AVM and SFAVM methods for a number of 60° intervals

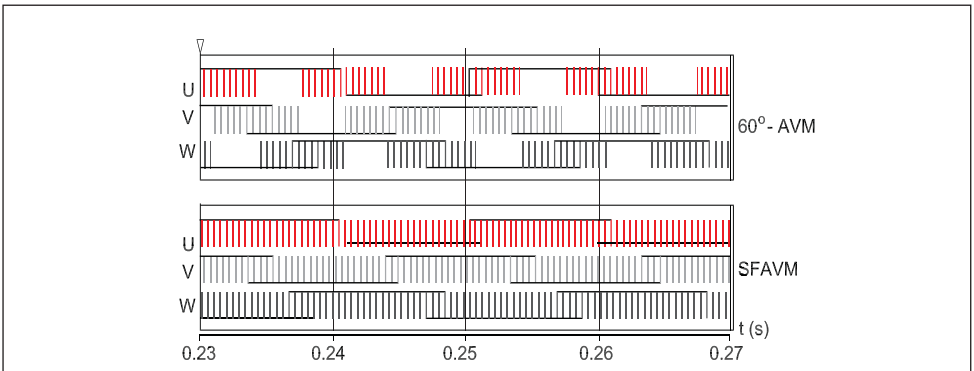

Fig. 2.19 Switching sequence of the 60° AVM and SFAVM methods for several periods

2.7 Control Circuit and Methods

The control circuit, or control card, is the fourth main component of the FC. The three hardware components dealt with so far (rectifier, intermediate circuit and inverter) are nearly always based on the same principles and components regardless of the manufacturer. In the majority of cases, these components are standard, nearly always purchased from the same external manufacturers.

The control circuit design stands in contrast to these, as the area where the FC manufacturer concentrates all its acquired knowledge.

In principle, the control circuit has four main tasks:

- Controlling the FC semiconductors. The semiconductors determine the anticipated dynamic characteristics or accuracy
- Exchanging data between the FC and peripherals (PLCs, encoders)
- Measuring, detecting and displaying faults, conditions and warnings
- Performing protective functions for the FC and motor

Using microprocessor technology, with single or dual processors, it is possible to increase control circuit speeds using ready-made pulse patterns that are stored in memory. As a result, there is a significant reduction in the number of calculations required.

With this type of control, the processor is integrated into the FC and is always able to determine the optimum pulse pattern for each operating stage. There are a variety of control methods available for determining the dynamic characteristics and response time in the event of a change in reference or torque as well as the positioning accuracy of the motor shaft.

In general, the basic functions of a FC can be summed up as follows:

- Rotating and positioning the rotor
- Open or closed-loop speed control of the AC motor
- Open or closed-loop torque control of the AC motor
- Monitoring and signalling operating states

Categorising the various voltage-source FC's available on the market (according to the form of control), at least six different types can be identified:

- Simple (scalar) without compensation control
- Scalar with compensation control
- Space vector control
- Open loop flux (field-oriented) control
- Closed loop flux (field-oriented) control
- Servo-controlled systems

This classification is illustrated in Fig. 2.20 Reaction time/precision classification speed control and Fig. 2.21 Torque performance control classification. Here, the response time refers to how long the FC needs to calculate a corresponding signal change to its output when there is a signal change at the input. The motor characteristics determine how long it takes to register a response on the motor shaft when an input signal is applied to the input of the FC.

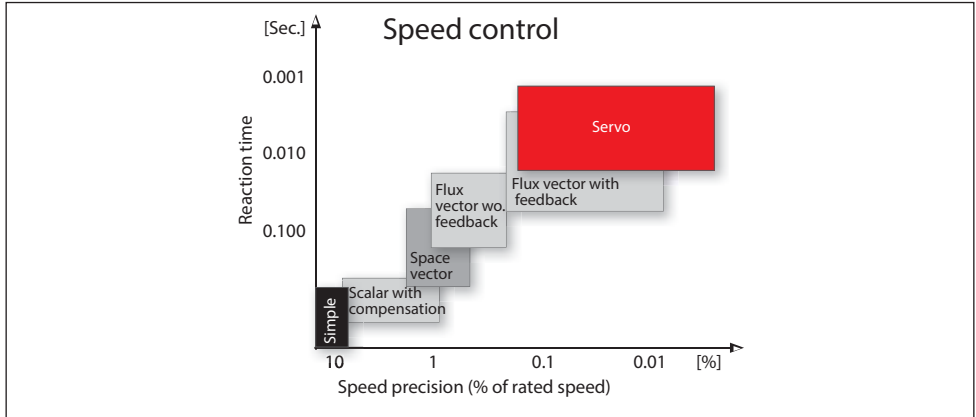

Fig. 2.20 Speed control performance control classification

The rated motor speed is used as the basis for establishing the speed accuracy. The rated motor speed is 50 Hz in most countries, and 60 Hz in the US.

FCs can be classified according to price/performance ratio. That is, a FC that uses a simple control method is better value for money for performing very simple tasks, than one featuring field-oriented control.

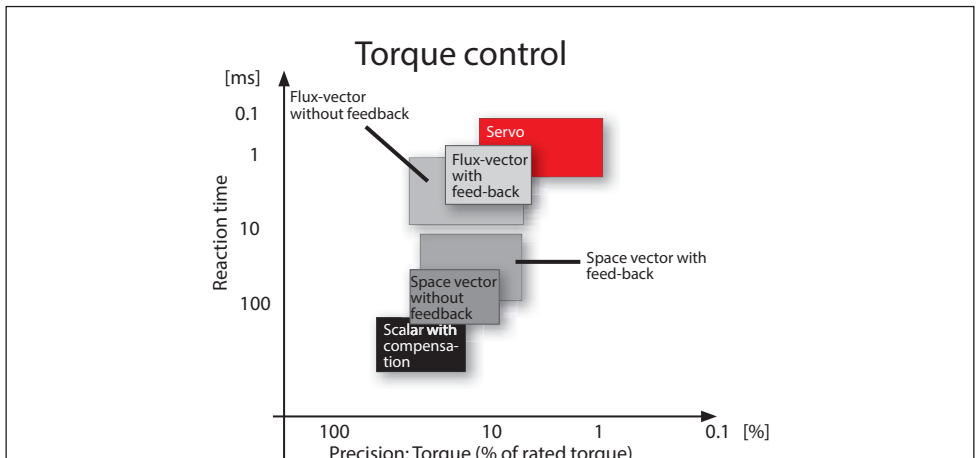

Fig. 2.21 Torque performance control classification

The speed setting ranges associated with the individual FC types are roughly as follows:

- Simple (scalar) without compensation 1:15
- Scalar with compensation 1:25
- Space vector 1:100(0)
- Flux (field-oriented) open loop 1:1000
- Flux (field-oriented) close loop 1:10.000
- Servo 1:10.000

The torque control performance can be classified as follows:

- The reaction time may be defined in the same way as for speed control
- The accuracy is determined in relation to the motor's rated torque

Please note that FCs that rely on a simple control method cannot be used for either open-loop or closed-loop control of the motor torque

2.7.1 Simple control method

This type of control is rarely used today. The control is in principle a fixed relationship between desired motor speed and a motor voltage. The model can be more or less refined, but the major disadvantages are:

- Unstable motor speed
- Difficult start of the motor
- No protection of the motor

The only advantage of simple control could be the low price, but since basic components for sensing motor are relatively low-cost, very few manufacturers now pursue this method.

2.7.2 Scalar Control with Compensation

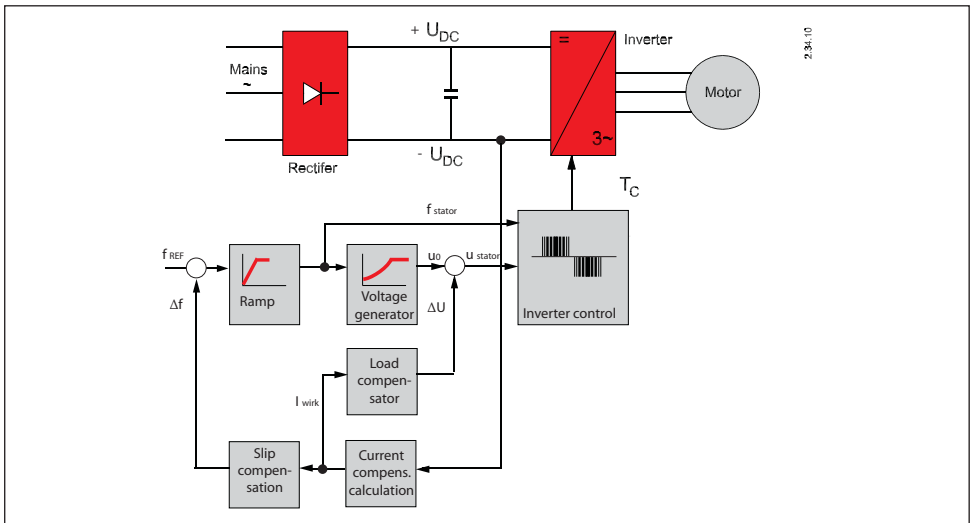

Fig. 2.22 Structure Scalar type Frequency Converter with compensation

When compared with simple control, FC with compensations adds three new control function blocks as illustrated in Fig. 2.22 Structure Scalar type Frequency Converter with compensation.

The load compensator uses the current measurement to calculate the additional voltage (ΔU) required to compensate for the load on the motor shaft.

The current is typically measured by means of a resistor (shunt) in the intermediate circuit. It is assumed that the power in the intermediate circuit is equal to the power consumed by the motor. If several active switch positions are combined, these can be used to reconstruct all the phase current information.

Basic features:

- Voltage/frequency [U/f] control with load and slip compensation
- Control of voltage amplitude and frequency

Typical shaft output:

- Speed setting range 1:25
- Speed accuracy $\pm 1\%$ of rated frequency
- Acceleration torque 40-90% of rated torque
- Speed change response time 200-500 ms
- Torque control response time Not available

Typical features:

- Improved control properties compared with simple scalar control
- Able to withstand sudden changes in load
- No external feedback signal required
- Unable to solve resonance problems
- No torque control properties
- Problems occur when attempting to control high-power motors
- Problems in the event of load changes in the low speed range

2.7.3 Space Vector with and without Feedback

The space vector control method is available with (“closed loop”) or without (“open loop”) an external motor speed feedback. As illustrated below, a feature allowing motor current polar transformation is added to the control (in the components responsible for magnetisation and torque-generating current).

The voltage angle (θ) is regulated in addition to the voltage (U) and frequency (f).

Basic features:

- Voltage vector control in relation to steady-state characteristic values (static)

Typical features:

- Improved dynamic performance compared with scalar control
- Very good at withstanding sudden changes in load (compared with scalar plus compensation)
- Operation at the current limit
- Possibility of active resonance dampening
- Possibility of open-loop/closed-loop torque control
- High starting and holding torque
- Problems during rapid reversing compared with flux vector
- No “rapid” current control

2.7.3.1 Space Vector (Open Loop)

If the space vector without external speed feedback speed and position will be calculated by the control software and is based on information about motor current and motor frequency which is measured (see example on page 74, Fig. 2.26 Basic principles of Danfoss VVCplus control).

Basic features:

- Voltage vector control in relation to steady-state characteristic values (static)

Typical shaft output:

- Speed setting range 1:100
- Speed accuracy (steady state) $\pm 0.5\%$ of rated frequency
- Acceleration torque 80-130% of rated torque
- Speed change response time 50-300 ms
- Torque change response time 20-50 ms

2.7.3.2 Space Vector (Closed Loop)

For the closed loop space vector method, an encoder or other device to detect the motor speed or position is required. It is the control software, the resolution on the feedback input and encoder's resolution that determines the accuracy of motor control.

Typical shaft output:

- Speed setting range 1 : 1000 – 10,000
- Speed accuracy (steady state) Depends on resolution of feedback component used
- Acceleration torque 80 – 130% of rated torque
- Speed change response time 50 – 300 ms
- Torque change response time 20 – 50 ms

2.7.4 Open Loop and Closed Loop Flux Vector Control

Flux vector control is also referred to as field-oriented control. The control methods referred to above control the motor magnetic flux via the stator. With field-oriented control, the rotor flux is controlled directly. The following motor variables are controlled within this context:

- Speed
- Torque

Once the rated data for the motor has been entered, a magnetic flux model can be used to determine the necessary voltage and angle for ensuring optimum motor magnetisation. The measured motor current is converted into a torque-generating current and a magnetising current. An internal PID controller is responsible for controlling the speed, with the feedback value being estimated on the basis of the measured motor current.

2.7.4.1 Flux Vector (Open loop)

Flux control requires accurate information about the condition, temperature, rotor position of the motor. It is a challenge to run open loop while the motor condition is being simulated. Obtaining optimum performance can be difficult, especially at low motor speed.

Typical shaft output:

- Speed setting range 1:50
- Speed accuracy (steady state) $\pm 0.5\%$ of rated frequency
- Acceleration torque 100-150% of rated torque
- Speed change response time 50-200 ms
- Torque change response time 0.5-5 ms

2.7.4.2 Flux Vector (Closed Loop)

For the closed loop flux vector control method, an encoder or similar sensor is required on the motor shaft. The control software and the feedback resolution determine the accuracy of motor control.

Control is performed in exactly the same way as with open loop methods. However, in this case the speed is calculated from the encoder signals rather than being estimated. Flux vector control is illustrated in Fig. 2.23 Structure closed loop flux vector control.

Typical shaft output:

- Speed setting range 1:1000 to 10,000
- Speed accuracy (steady state) Dependent on the feedback signal (encoder) used
- Acceleration torque 100 – 150% of rated torque
- Speed control response time 5.00 – 50 ms
- Torque control response time 0.50 – 5 ms

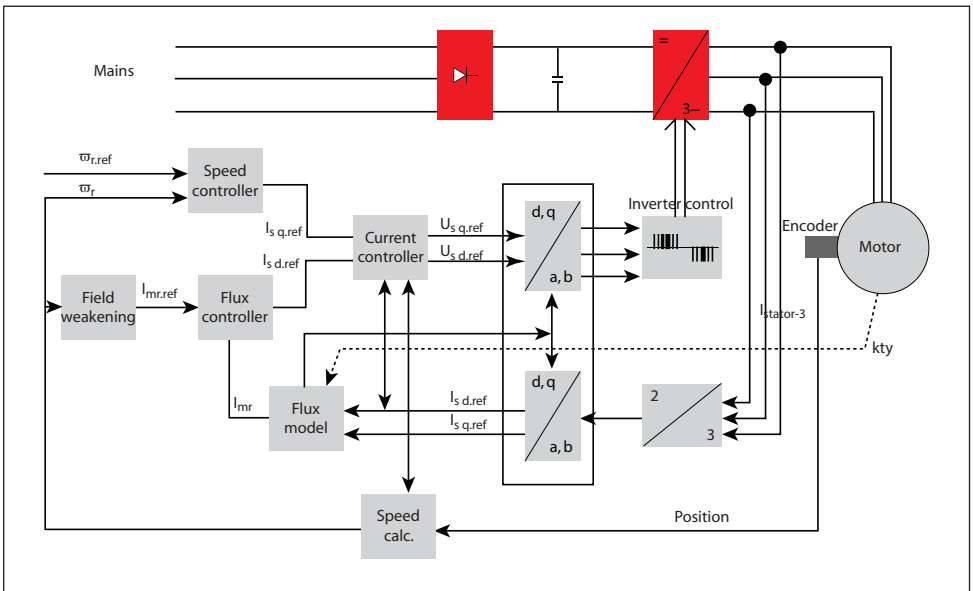

Fig. 2.23 Structure closed loop flux vector control

2.7.5 Servo Drive Control

The servo converter control method will not be explored in depth here.

One common method is very similar to closed loop flux control, but to ensure high

dynamic response, the power components and hardware may be upgraded as much as two, three or four times the power components in a FC to ensure available current and torque.

2.7.6. Control Conclusions

In conclusion, all control methods are primarily handled by the software. The more dynamic the motor control needs to be, the more complex the control algorithm required.

A similar principle applies for initial use of a FC. Initial use of a simple FC does not involve a great deal of programming. In most cases, all you have to do is enter the motor data. However, for applications that require a flux vector control or critical applications like hoists, more complex programming is required, right from initial use.

Due to the fact that the control is mainly a software issue, many manufacturers have implemented several control methods in their units, for example U/f, space vector, or field-oriented control. Parameters are needed to switch from one control method to another, for example from space vector control to the flux vector method. Pop-up menus help the operator to set the parameters needed for each control method, in order to meet the application demands.

2.8 Danfoss Control Principles

A general overview of the standard current control principles for Danfoss FCs is illustrated in Fig. 2.24 Basic principles of current standard frequency converters from Danfoss.

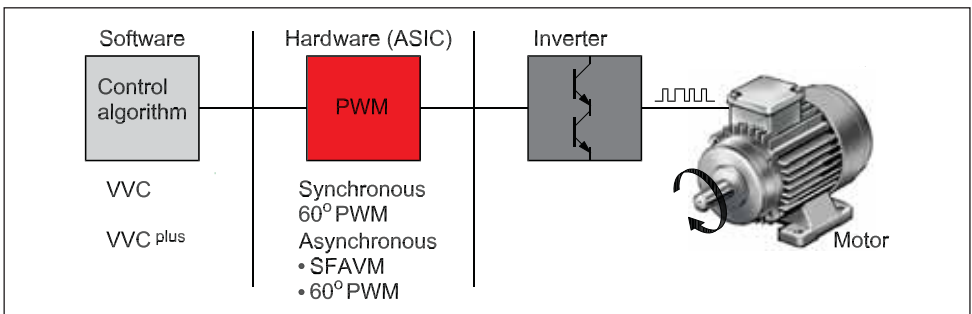

Fig 2.24 Basic principles of current standard frequency converters from Danfoss

The PWM switching patterns are calculated for the inverter using the selected control algorithm. U/f control is suitable for applications involving

- Special motors (for example, sliding rotor motor)
- Motors connected in parallel

In the case of the applications referred to above, no compensation of the motor is required. With the VVCplus control principle, the amplitude and angle of the voltage vector are controlled directly, as is the frequency. At the heart of this method lies a straightforward, yet robust, motor model. The type of control method involved is called Voltage Vector Control (VVC).

Some of the features offered include:

- Improved dynamic properties in the low speed range (0 - 10 Hz)
- Improved motor magnetisation
- Speed control range: 1:100 opened loop
- Speed accuracy: $\pm 0.5\%$ of the rated speed without feedback
- Active resonance dampening
- Torque control
- Operation at the motor current limit

2.8.1 Danfoss VVCplus Control Principle

The Danfoss VVCplus control principle uses a vector modulation method for constant voltage-source PWM inverters. Depending on the application control demands, the motor equivalent diagram can be simplified (that is, the iron, copper and air flow losses are ignored) or used in its full complexity.

Example:

A simple fan or pump application control uses a simplified motor diagram. However a dynamic hoist application requiring flux vector control requires the complex motor equivalent diagram, accounting for all losses in the control algorithm.

The inverter switching pattern is calculated using either the SFAVM or 60° AVM principle, to keep the pulsating torque in the air gap very small. The user can select the preferred operating principle, or allow the control to select one automatically on the basis of the heatsink temperature. When the temperature is below 75° C, the SFAVM principle is used for control. At temperatures above 75°, the 60° AVM principle is applied.

The control algorithm takes two operating conditions into consideration:

- No-load state (idle state), see Fig. 2.25a Motor equivalent circuit diagram under “no-load”. In the no-load state, there is no load on the motor shaft. For conveyors the no-load state literally means no products are being transported. It is simply assumed the current drawn by the motor is only needed for magnetisation and compensation for losses. The active current is considered to be nearly zero. The no-load voltage (U_L) is determined on the basis of the motor data (rated voltage, current, frequency, speed).

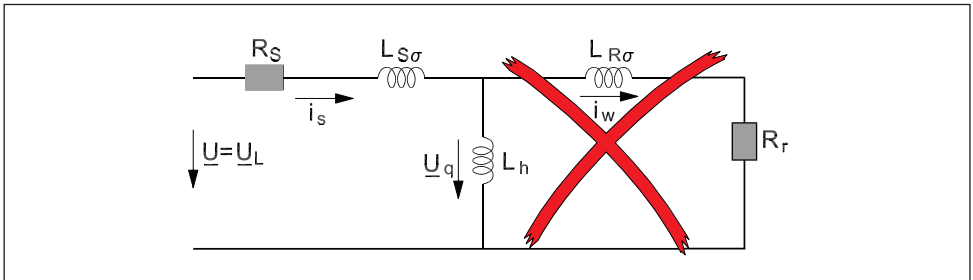

Fig. 2.25a Motor equivalent circuit diagram under “no-load”

- Loaded state
 The motor shaft is loaded, implying that products are being transported, as shown in Fig. 2.25b Motor equivalent circuit diagram under “load”.
 The motor draws more current when it is loaded. In order to produce the required torque the active current (i_w) is needed. Losses in the motor (especially in lower speed range) need to be compensated for. A load-dependent additional voltage (U_{Comp}) is made available to the motor:

$$U = U_{LOAD} = U_L + U_{Comp}$$

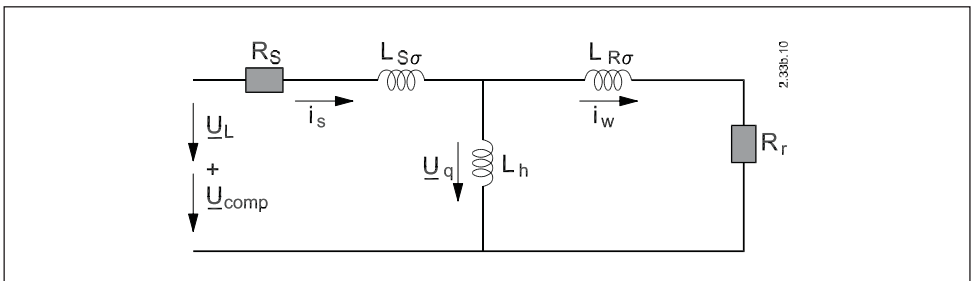

Fig. 2.25b Motor equivalent circuit diagram under “load”

The additional voltage U_{Comp} is determined using the currents measured under the two conditions mentioned above (loaded and no-load) as well as the speed range: low or high speed. The voltage value and the speed range are then determined on the basis of the rated motor data.

The control principle is illustrated in the block diagram below:

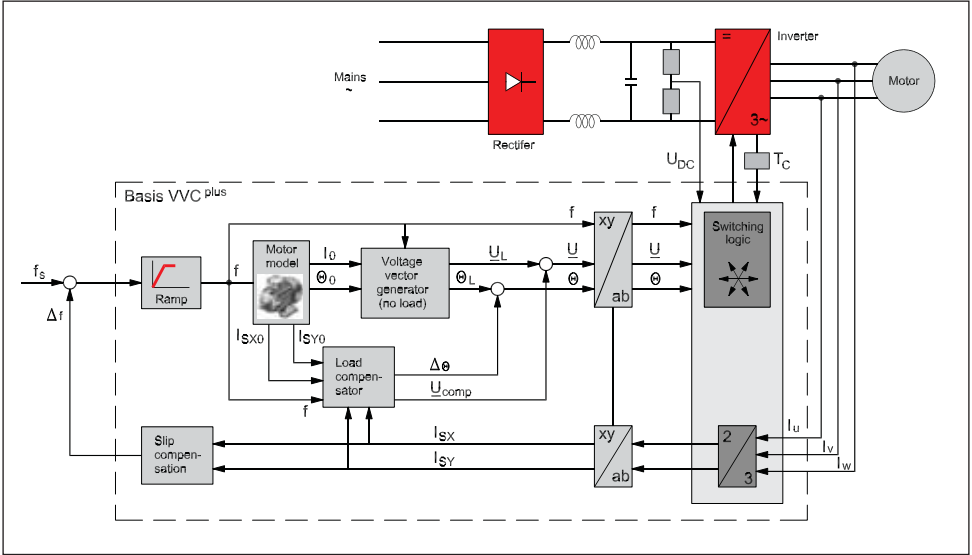

Fig. 2.26 Basic principles of Danfoss VVCplus control

As shown in Fig. 2.26 Basic principles of Danfoss VVCplus control, the motor model calculates the no-load references (currents and angles) for the load compensator (I_{SX} , I_{SY}) and the voltage vector generator (I_0 , θ_0).

The voltage vector generator calculates the no-load voltage (U_L) and the angle (θ_L) of the voltage vector on the basis of the no-load current, stator resistance and stator inductance.

The measured motor currents (I_u , I_v and I_w) are used to calculate the reactive current (I_{SX}) and active current (I_{SY}) components.

Based on the calculated currents (I_{SX0} , I_{SY0} , I_{SX} , I_{SY}) and the voltage vector actual values, the load compensator estimates the air-gap torque and calculates how much extra voltage (U_{Comp}) is required to maintain the magnetic field strength at the reference value. It then corrects the angle deviation ($\Delta\theta$) that is to be expected due to the load on the motor shaft. The output voltage vector is represented in polar form (p). This enables direct overmodulation and facilitates connection to the PWM ASIC.

Voltage vector control is particularly useful for low speeds, where the dynamic performance of the drive can be significantly improved (compared with U/f control) by means of appropriate control of the voltage vector angle. In addition, steady-state behaviour improves, since the control system can make better estimates for the load torque on the basis of the vector values for both voltage and current than it would be able to on the basis of the scalar signals (amplitude values).

f	Internal frequency
f_s	Reference frequency set
Δf	Calculated slip frequency
I_{SX}	Reactive current (calculated)
I_{SY}	Active current (calculated)
I_{SX0}, I_{SY0}	No-load current of x/y axis (calculated)
I_U, I_V, I_W	Measured phase current (U, V, W)
R_s	Stator resistance
R_r	Rotor resistance
θ	Voltage vectors angle
θ_0	"No-load" theta value
$\Delta\theta$	Load-dependent angular compensation
T_c	Heat-sink temperature (measured)
U_{DC}	Intermediate circuit voltage
U_L	No-load voltage vector
U_s	Stator voltage vector
U_{Comp}	Load-dependent voltage compensation
U	Motor supply voltage
X_h	Reactance
X_1	Stator leakage reactance
X_2	Rotor leakage reactance
ω_s	Stator frequency
L_s	Stator inductance
L_{Ss}	Stator leakage inductance
L_{Rs}	Rotor leakage inductance

Table 2.3 explanations of symbols used in:

Fig. 2.23 Structure closed loop flux vector control

Fig. 2.24 Basic principles of current standard frequency converters from Danfoss

Fig 2.25a Motor equivalent circuit diagram under "no-load"

Fig. 2.25b Motor equivalent circuit diagram under "load"

Fig. 2.26 Basic principles of Danfoss VVCplus control

2.8.2 Danfoss Flux Vector Control Principle

The principle of flux vector control assumes that a complete equivalent circuit diagram data is available. With this approach, all the relevant motor parameters are taken into account by the control algorithms. Considerably more motor data needs to be specified than is the case with the basic VVCplus control.

Changing a single parameter during commissioning switches the control algorithm from VVCplus control to flux vector control. Here more information needs to be fed in to the drive for smooth control of the motor. All parameters will not be explained here as they are fully explained in the operation manuals.

A brief description of the control strategy is shown in Fig. 2.27 Basic principles of Danfoss Flux Vector control. A flux database is stored in the frequency converter. The currents measured in all 3 phases are transformed in to polar coordinates (xy).

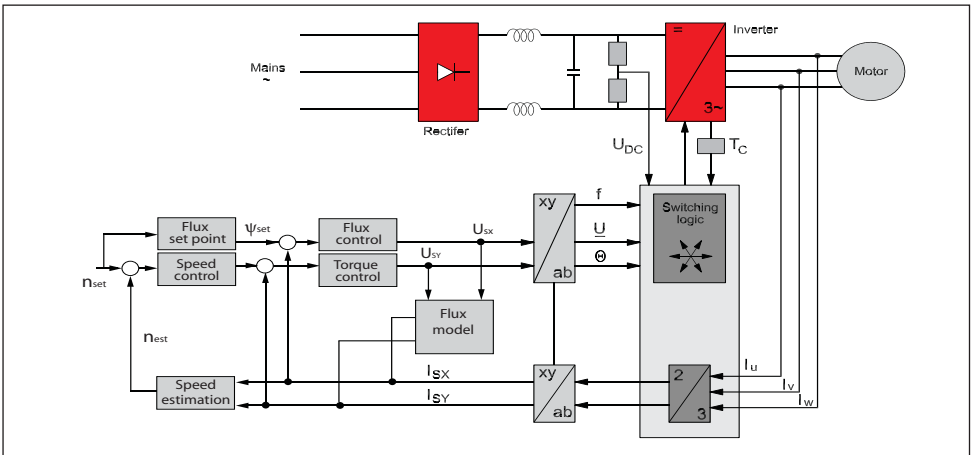

Fig. 2.27 Basic principles of Danfoss Flux Vector control

2.9 Standards and Legislations

As for all other products legislations and technical standards are worldwide available to ensure safe operation of FC's.

Legislation is issued by the legislative branch of national or local government and can of course be different in the different countries around the globe. However it is mandatory to comply with – it is law. It is a political document, typically free of specific technical details – these details can be found in standards.

Standards are written by experts in relevant standardisation bodies (such as the International Electrotechnical Commission IEC or the European Committee for Electrotechnical Standardisation CENELEC) and reflect the technical state of the art. Their role is to establish a technical common ground for cooperation between market players. Typically IEC standards are accepted in the majority of countries and local standards (EN, NEMA) will be harmonised to fit them.

Manufacturers have to demonstrate and document compliance with the local legislations by following the standards otherwise they are not allowed to sell their product in the local market. On the product itself the compliance is indicated by symbols.

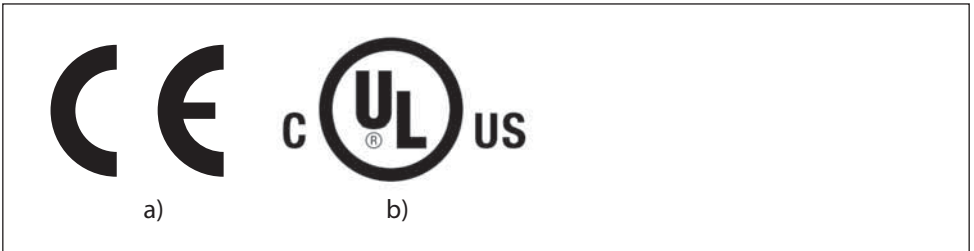

Fig. 2.28 CE-Marking (a) and ul listing (b)

Which standards have been applied and which legislative conformance has been stated is noted for example in Europe in the Declaration of Conformity. For a better understanding this book address several standards connected to FC's and some relevant legislative measures.

3 Frequency Converters and Motors

In the previous chapters, the motor and the FC were each presented in isolation. This chapter explains the interaction between the two components.

3.1 Basic Principles

3.1.1 U/f Operation and Field Weakening

The major technical characteristics of a motor are found on its nameplate. The information shown is very relevant for the electrical installer, because values for voltage, frequency and full load current are given, but important information for the mechanical design is missing and can be found in the datasheet, catalogue, or by direct contact to the motor manufacturer.

This mechanical design information includes data related to motor start and intermittent operation, and also the available torque at the motor shaft. The shaft torque is easy to calculate from the nameplate data.

For a given load, the following expression applies:

$$T = \frac{P \times 9550}{n} = \frac{n \times \sqrt{3} \times V \times I \times \cos \varphi \times 9550}{f \times 60/p \times (1-s)} = \frac{k \times V \times I}{f}$$

This results in the principle relation:

$$T \sim V/f \times I$$

This relation is utilised in voltage source FC's which maintain a constant ratio between the voltage (U) and the frequency (f). This constant ratio (U/f) determines the magnetic flux density (Φ) of the motor and is determined by the motor nameplate data (for example, 400 V/50 Hz = 8 [V/Hz]). The constant flux density ensures optimum torque from the motor. Ideally the ratio 8 [V/Hz] means that each 1 Hz change in the output frequency will result in an 8 V change in the output voltage. This way of controlling the output values of the FC is called "U" to "f" characteristic control.

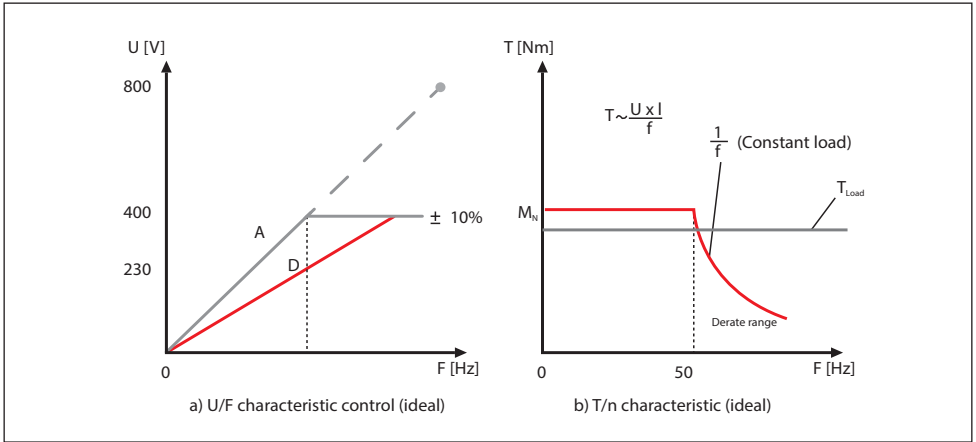

Fig. 3.1 Principle U/f characteristic and torque

The ideal curve of the U/f characteristic for a star connected 50 Hz motor is shown in Fig. 3.1 Principle U/f characteristic a) applied motor voltage b) resulting torque. Up to 50 Hz the FC applies a constant U/f ratio to the motor which result in the possibility to get a constant torque out of the motor.

For operating the motor at 100 Hz ideally the output voltage should be increased to 800 V to maintain a constant U/f ratio (dotted line in Fig. 3.1a Principle U/f characteristic and torque). As this high voltage is critical for the motor insulation this is not an applied strategy. Typically the FC limit its output voltage to the value of the input (for example 400 ±10%)

This means that the FC can maintain a constant U/f ratio to a certain frequency only. After this frequency it can continue to the frequency but not the voltage anymore. As this is affecting the U/f ration the magnetic flux density is reduced. Therefore this speed range is also called field weakening area. (Fig. 3.1b Principle U/f characteristic and torque) The reduced magnetic field results in a reduced maximum motor torque. While the nominal torque is reduced by 1/f the stall torque decreases by 1/f².

Please note that the shown curves are ideal and require some compensation which are described in the following sections.

3.1.2 87 Hz Characteristics

Typically asynchronous motors operated with FC's are configured to the nominal voltage of the mains. This means that 400 V/230 V motor will be configured in star when operated by a 400 V FC. As described in the previous section a 50 Hz motor will enter field weakening when the voltage can't be increased any more. For extending the speed range the motor can be configured in delta.

Example

Motor: 15 kW, 400V/230V λ/Δ , 27.5A/48,7A, 50 Hz

At 50 Hz the power in star and delta configuration is 15 kW because of the different mains voltage which result in different motor currents.

$$P_{\lambda} (50 \text{ Hz}) = \sqrt{3} \times 400\text{V} \times 27.5\text{A} \times \cos \varphi \times \eta = 14.92 \text{ [kW]}$$

$$P_{\Delta} (50\text{Hz}) = \sqrt{3} \times 230\text{V} \times 48.7\text{A} \times \cos \varphi \times \eta = 15.19 \text{ [kW]}$$

With delta connection it can be seen in Fig. 3.2 87 Hz characteristic that in contradiction to the start configuration the motor runs with constant U/f ratio up to 230 Volt, but if the FC is powered from a 400 Volt supply, we are actually able to keep the constant U/f ratio up to 400 Volt and the high current ,

$$P_{\Delta} (87\text{Hz}) = \sqrt{3} \times 400 \text{ V} \times 48.70 \text{ A} \times \cos \varphi \times \eta = 26.42 \text{ [kW]}$$

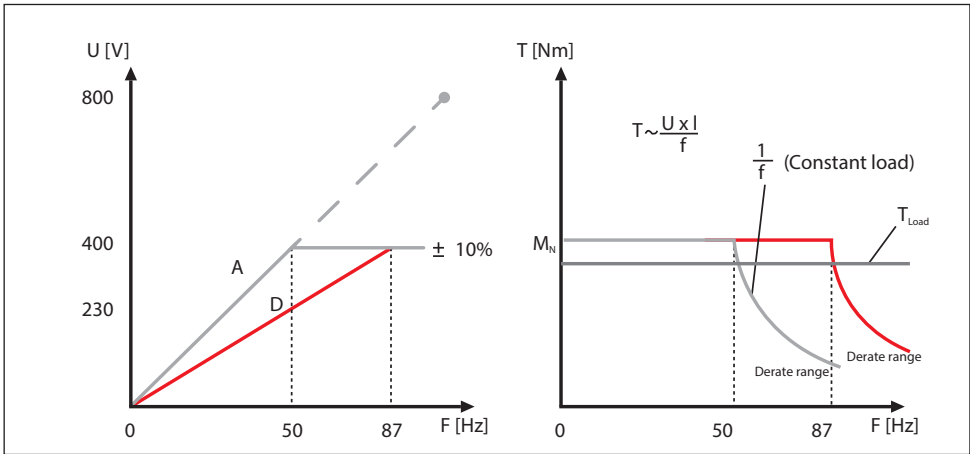

Fig. 3.2 87 Hz characteristic

This means we have the rated flux density (Φ) up to 400 Volt even the motor is configured for 230 Volt. With this higher voltage we can increase the maximum frequency with rated flux to 87 Hz.

The use of this knowledge presupposes the following:

- The selected FC must easily be able to handle the higher delta current (48.70 A)
- The motor must be wound such that it can withstand the required operating voltage (typically higher in the star configuration) supplied by the FC (i.e. with a 690 V supply voltage and a 690 V FC, this application is only possible with a motor wound for 690 V / 400 V λ/Δ)
- The torque on the motor shaft remains the same for both configurations up to 50 Hz. Hz. Above 50 Hz, a star-connected motor enters the field weakening range. When it is delta-connected, this does not happen until approximately 90 Hz. If the $\pm 10\%$ tolerance of the FC is used, the field weakening range begins at 55 Hz or 95 Hz respectively. The torque decreases because the motor voltage is not increased

The benefits of this increased motor capacity utilisation are:

- An existing FC can be operated with a greater speed control range.
- A lower-power rating motor can be used. Such a motor can have lower moment of inertia which allows higher dynamics. This improves the dynamic characteristics of the system.

Please note that operation of a 400V/230V λ/Δ motor in delta at 400 V is only possible on a FC because of the higher feeding frequency of 87 Hz. Operation direct on 400 V/ 50 Hz mains will destroy the motor!

3.1.3 Running in Current Limit

As seen, the relationship between motor shaft torque and motor current indicates that if motor current can be controlled, then the torque is also under control. If an application temporarily needs torque up to maximum it is essential that the FC is designed for continuous operation current up to the current limit, and not exceed it or trip.

There are different strategies for designing the FC to run in current limit situations. The most typical strategy is the fact that torque will be reduced when the speed is reduced. But as we shall see later there can be applications where this strategy cannot be utilised and can even cause bigger problems.

3.2 Compensations

It used to be difficult to tune a FC to a motor because some of the compensation functions, such as “start voltage”, “start compensation” and “slip compensation”, are difficult to relate to practice.

These compensations are required because motor characteristics are not linear. For example an asynchronous motor requires a greater current at low speed to accomplish both magnetising current and torque-producing current for the motor. The built-in compensation parameters ensure optimum magnetisation and hence maximum torque:

- During start
- At low speeds
- In the range up to the rated speed of the motor

In the latest generation of FCs, the device automatically sets the necessary compensation parameters once the motor rating details of the motor have been programmed into the FC. These details include voltage, frequency, current and speed. This applies to approximately 80% of standard applications such as conveyors and centrifugal pumps. Normally, these compensation settings can also be changed manually for fine tuning applications such as hoisting or positive displacement pumps if required.

3.2.1 Load-independent Start Compensations

Increase the output voltage in the lower speed range by manually setting an additional voltage, often called start voltage.

Example

A motor which is much smaller than the recommended motor size of an FC may require an additional, manually adjustable voltage boost in order to overcome static friction or ensure optimum magnetisation in the low speed range.

If several motors are controlled by one FC (parallel operation), it is recommended to de-activate the load-independent compensation.

The load-independent supplement (start voltage) ensures an optimum torque during start.

3.2.2 Load-dependent Start Compensations

The load-dependent voltage supplement (start and slip compensation) is determined via the current measurement (active current).

This compensation is normally called the $I \times R$ compensation, boost, torque increase, or, – at Danfoss, – start compensation.

This type of control reaches its limits when the disturbances are difficult to measure and the load is highly variable (for example in motors with operational change in the winding resistance of up to 25 % between the hot and cold states).

The voltage increase may have different results. Under no-load operation, it may lead to saturation of the motor flux. In the event of saturation, a high reactive current will flow that leads to heating of the motor. If the motor is operating with a load, it will develop little torque because of the weak main flux and may stop running.

The real U/f and T/n characteristics are generally as shown in Fig. 3.3 Real U/f and T/n characteristic.

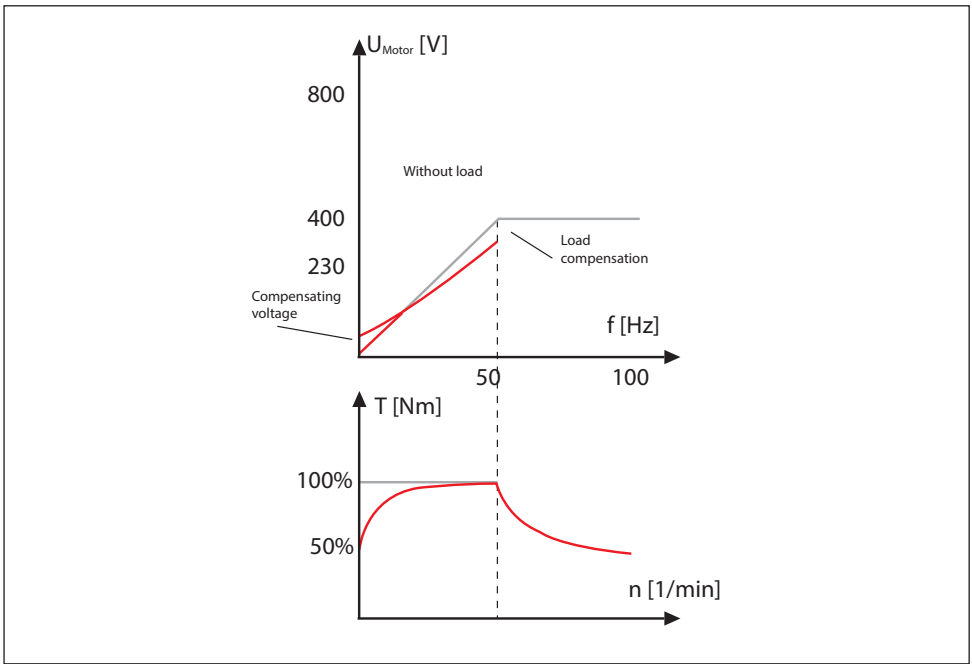

Fig. 3.3 Real U/f and T/n characteristic

In Fig. 3.3, additional voltage is supplied to the motor at low speeds for the purpose of compensation.

3.2.3 Load Compensations

The motor voltage is increased under load ascertained from the measured motor current.

The output voltage receives a voltage boost which effectively overcomes the influence of the DC resistance of the motor windings at low frequencies and during start.

An increase in output voltage leads to over-magnetisation of the motor. This increases the thermal load on the motor such that a reduction in torque is to be expected. The motor voltage is reduced in no-load operation.

3.2.4. Slip compensation

The slip of an asynchronous motor is load-dependent and typically amounts to some 5% of the rated speed. For a two-pole motor, this means that the slip will be around 150 RPM.

However, the slip will be approximately 50% of the required speed if the FC is controlling a motor at 300 RPM (10 % of the rated synchronous speed of 3000 RPM).

If the FC has to control the motor at 5 % of the rated speed, the motor will stall if it is loaded. This load dependence is undesirable, and the FC is able to fully compensate for this slip by effectively measuring the active current to the motor.

The FC then compensates for the slip by increasing the frequency according to the actual measured current. This is called active slip compensation.

The FC calculates the slip frequency (f_{slip}) and the magnetisation or no-load current (I_{ϕ}) from the motor data. The slip frequency is scaled linearly to the active current (difference between no-load and measured current).

Example

A 4-pole motor with a rated speed of 1455 RPM has a slip frequency of 1.5 Hz and a magnetisation current of approximately 12 A.

With a load current of 27.5 A and 50 Hz, the FC will output a frequency of about 51.5 Hz. At a load current between I_{ϕ} (12 A) and I_N (27.5 A), the frequency will be adjusted accordingly between zero and 1.5 Hz.

As demonstrated in the example, factory setting of slip compensation is often scaled such that the motor runs at the theoretical synchronous speed. In this case, $51.5 \text{ Hz} - 1.5 \text{ Hz} = 50 \text{ Hz}$.

3.2.5 PM Motor and SynRM Compensations

For Permanent Magnet motors the start and slip compensations are irrelevant, but other parameters are essential.

The magnetising profile differs of course from the asynchronous motor, but other important data and compensations are:

- Nominal motor speed and frequency
- Back EMF
- Max speed before back EMF damages the FC
- Field weakening
- Dynamic details relevant for the control

For SynRM motors other parameters are essential, for instance:

- Stator resistance
- d and q axis inductances
- Saturation inductances and
- Saturation point

3.3 Automatic Motor Adaptation (AMA)

Motor data on the motor nameplate or from the motor manufacturer's datasheet are given for a specific range of motors, or a specific design, but rarely do those values refer to the individual motor. Due to variations in the production of motors and the installation, those motor data are not always accurate enough to ensure optimal operation.

Also as seen above there are several compensations which require setting. For modern FC's, fine-tuning to the actual motor and installation can be a complicated and troublesome task.

In order to make installation and initial commissioning easier, automatic configuration functions like the Automatic Motor Adaption (AMA) from Danfoss are becoming increasingly common. These functions measure for example the stator resistance and inductance. The effect of the cable length between FC and motor is also taken into account.

The parameters required for different motor types differ in important details. For instance, the back EMF value is essential for PM motors and saturation point level is important for SynRM motors. Therefore different types of AMA are required. Note that not all FCs support the AMA function for all motor types.

In principle two types of AMA are used:

Dynamic

The function accelerates the motor to a certain speed to perform the measurements. Typically the motor must be disconnected from the load /machine for "identification run".

Static

The motor is measured at standstill. This means there is no requirement to disconnect the motor shaft from the machine. It is important, however, that the motor shaft is not rotated by external influences during measurement.

3.4 Operation

3.4.1 Motor Speed Control

The output frequency of the FC, and thus the motor speed, is controlled by one or more signals (0-10 V; 4-20 mA, or voltage pulses) as a speed reference. If the speed reference increases, the motor speed goes up and the vertical part of the motor torque characteristics is shifted to the right (Fig. 3.4 Reference signal and motor torque relation).

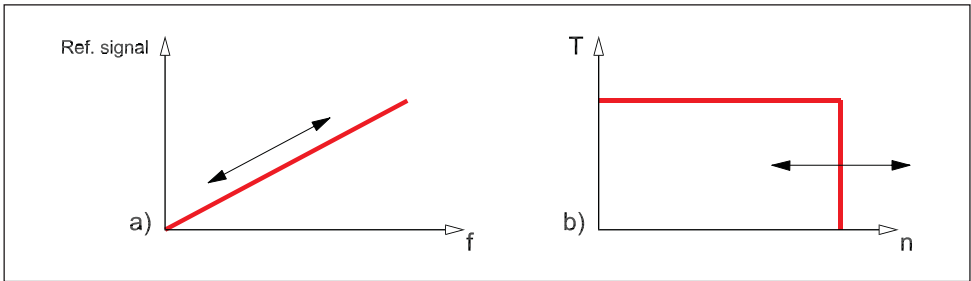

Fig. 3.4 Reference signal and motor torque relation

If the load torque is less than the motor torque, the speed will reach the required value. As shown in Fig. 3.5 Relation current limit and over current limit, the load torque curve intersects the motor torque curve in the vertical part (at point A). If the intersection is in the horizontal part (point B), the motor speed cannot continuously exceed the corresponding value. The FC allows brief current limit overshoots without tripping (point C), but it is necessary to limit the duration of the overshoot.

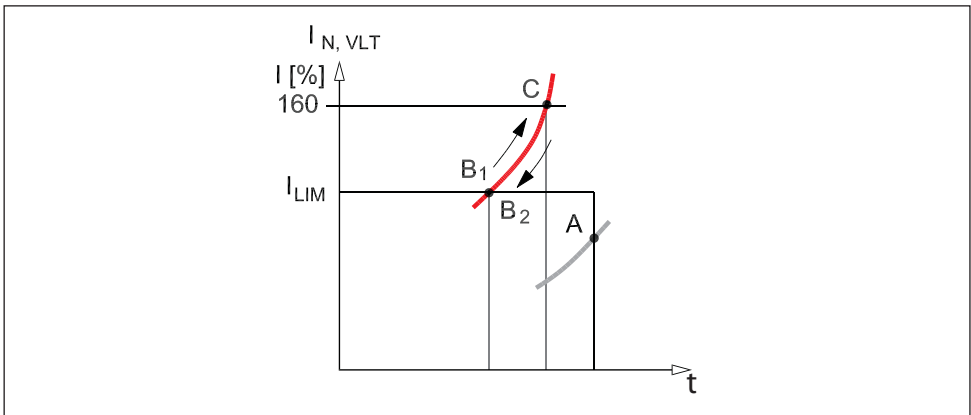

Fig. 3.5 Relation current limit and over current limit

3.4.2 Reversing

The direction of rotation of asynchronous and many synchronous motors is determined by the phase sequence of the supply voltage. If two phases are swapped, the direction of rotation of the motor changes (the motor reverses).

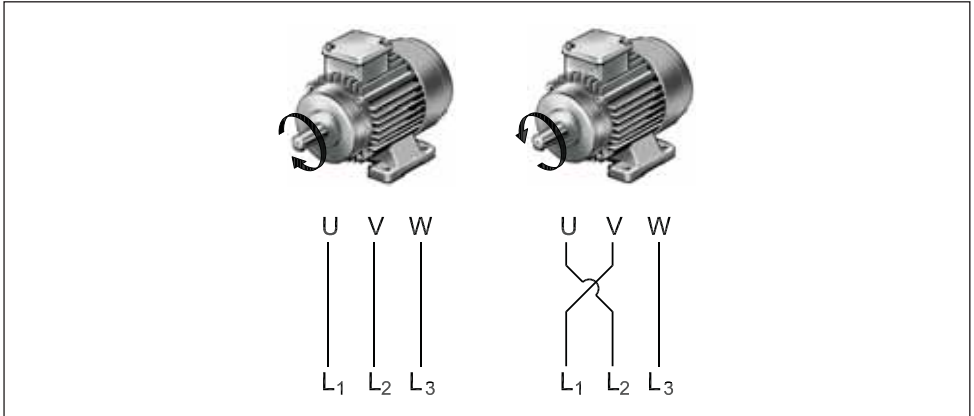

Fig. 3.6 The rotation direction of the motor reverses when the phase sequence is changed

A FC can reverse the motor by electronically changing the phase sequence. Reversing is accomplished by either using a negative speed reference or a digital input signal. If the motor must have a specific direction of rotation when first put into service, it is important to know the factory default setting of the FC.

Since a FC limits the motor current to the rated value, a motor controlled by a FC can be reversed more frequently than a motor connected directly to the mains.

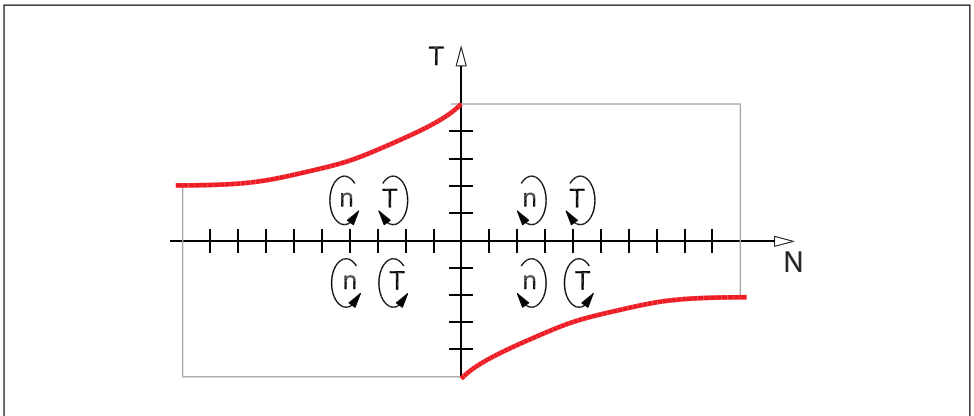

Fig. 3.7 Braking torque of the frequency converter during reversing

3.4.3. Acceleration and Deceleration Ramps (Ramp Up and Down)

For many applications there are various reasons why the speed must not change too quickly but instead must be changed slowly or with smooth transitions. All modern FCs have ramp functions to facilitate this. These ramps are adjustable and ensure that the speed reference is able to increase or decrease only at a preset rate.

The acceleration ramp (ramp up) indicates how quickly the speed is increased. It is stated in the form of an acceleration time t_{acc} and indicates how quickly the motor should reach the new speed. These ramps are mostly based on the rated motor frequency, e.g. an acceleration ramp of 5 seconds means that the FC will take 5 seconds to go from standstill to the rated motor frequency ($f_n = 50$ Hz).

However there are some manufacturers who relate the acceleration and deceleration to the values between the minimum and maximum frequency.

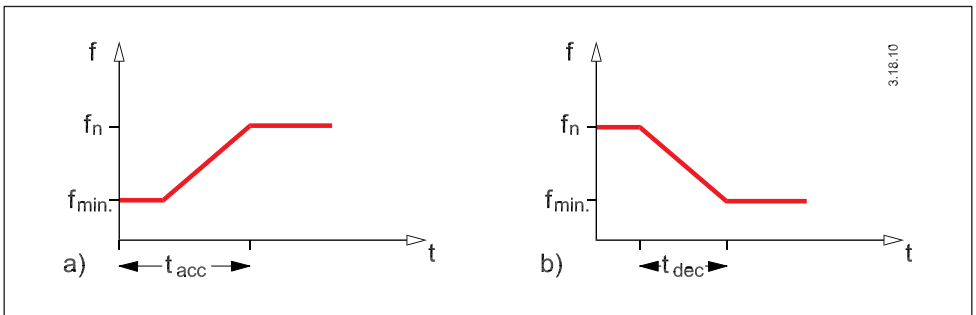

Fig. 3.8 Acceleration and deceleration times

The deceleration ramp (ramp down) indicates how quickly the speed is decreased. It is stated in the form of a deceleration time t_{dec} and indicates how quickly the motor should reach the new reduced speed.

It is possible to go directly from acceleration to deceleration, since the motor always follows the output frequency of the inverter.

Ramp times can be set to such low values that in some situations the motor cannot follow the preset speed.

This leads to an increase in the motor current until the current limit is reached. In the case of short ramp-down times, the voltage in the intermediate circuit may increase to such a level that the protective circuit will stop the FC.

If the inertia of the motor shaft and the referred inertia of the load are known, the optimum acceleration and deceleration times can be calculated.

$$t_{\text{acc}} = J \times \frac{n_2 - n_1}{(T_{\text{acc}} - T_{\text{fric}}) \times 9.55}$$

$$t_{\text{dec}} = J \times \frac{n_2 - n_1}{(T_{\text{acc}} + T_{\text{fric}}) \times 9.55}$$

J is the moment of inertia of the motor shaft and load [kgm²].

T_{fric} is the friction torque of the system [Nm].

T_{acc} is the overshoot torque used for acceleration [s].

T_{dec} is the braking torque that occurs when speed reference is reduced [s].

n_1 and n_2 are the speeds at frequencies f_1 and f_2 [min⁻¹].

If the FC allows an overload torque for a brief time, the acceleration and deceleration torques are set to the rated motor torque T . In practice, the acceleration and deceleration times are normally identical.

Example

A machine has the following specifications:

$$J = 0.042 \text{ kgm}^2$$

$$n_1 = 500 \text{ min}^{-1}$$

$$n_2 = 1000 \text{ min}^{-1}$$

$$T_{\text{fric}} = 0.05 \times T_N$$

$$T_N = 27 \text{ Nm}$$

Theoretical acceleration time can be calculated as follows:

$$t_{\text{acc}} = J \times \frac{n_2 - n_1}{(T_{\text{acc}} - T_{\text{fric}}) \times 9.55} = \frac{0.042 \times (1000 - 500)}{(27.0 - (0.05 \times 27.0)) \times 9.55}$$

The ramp functions ensure that there is no abrupt change of speed, provided the FC is set to the calculated acceleration. This is essential for many applications like:

- Ensuring bottles do not topple over on bottle transporting conveyors
- Preventing water hammer in pump systems
- Comfort in escalators or lifts

Most often linear ramps are used. However different characteristics are possible for different applications, for example, an "S" or "S²" ramp.

With the "S" ramp, the transitions to and from standstill are particularly gentle.

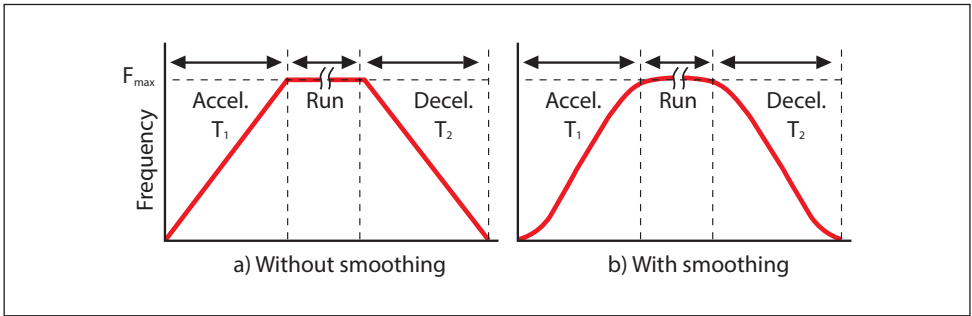

Fig. 3.9 Linear ramp a) and S-ramp (b)

3.4.4 Motor Torque Control

Motor torque is another parameter which is important for the application, as shown in Fig. 3.5 The motor current can overshoot the current limit briefly.

Torque is the basis for the rotation or movement of a load. Reasons for controlling the torque include:

- Limiting the torque to prevent damage on machine etc.
- Control the torque to make more motors share the load.

If an application is suddenly overloaded, and the FC is sized for overload, the machine can work for a given time in the overload mode. However this excessive torque can be fatal for the machine or reduce the lifetime. Therefore, many FC's can be programmed to send a warning in case of overload, but also limit the torque under specific conditions.

As described in section 3.1 Basic Principles there is a relationship between current and torque. This relationship is not direct, but depends on slip, $\cos \phi$ and temperature in the motor. The limitation based on measuring the current is not accurate. If the FC is the Space Vector type or the flux type (see chapter 2 Frequency Converters) the current is measured vectorially in all three motor phases, and the distribution of the current components is easy. With this information the FC can calculate the torque precisely enough to make sure the machine is protected.

In situations where more motors are on a common mechanical system, it is essential that the motors share the load equally. If the slip compensation factor is reduced, the motors will automatically balance their torque, but not necessarily maintain the desired speed.

Another function in some FC's is called the Droop function. Droop function means that one motor is controlling the speed and additional FC's follow the same speed and automatically share the load.

Example

A 100 meter long conveyor belt has numerous drive stations distributed along the belt. If one of the motors tends to run a bit faster than the other, this motor will have to give more torque. The result can be:

- The motor can be overloaded and overheated
- The belt can be damaged because of the partial higher torque
- Pulleys and drive drums may slip with excessive wear as result

In such situations, torque and torque sharing is important.

3.4.5 Watchdog

FC's can monitor the process being controlled and intervene in case of operational disturbance. This monitoring can be divided into three areas: machinery, motor, and FC.

The machinery is monitored by

- Output frequency
- Output current
- Motor torque

Based on these values, a number of limits can be set which intervene in the control function if they are exceeded. These limits could be the lowest permissible motor speed (minimum frequency), the highest permissible motor current (current limit) or the highest permissible motor torque (torque limit). If the limits are exceeded, the FC can, for example, be programmed to:

- give a warning signal,
- decrease the motor speed or
- stop the motor as fast as possible

Example

In an installation using a V-belt as a connection between the motor and the rest of the installation, the FC can be programmed to monitor the V-belt.

As expected, the output frequency increases more quickly than the preset ramp. If the V-belt breaks, the frequency can be used to either give a warning or stop the motor.

3.5 Dynamic Brake Operation

Machines can create potential or kinetic energy which we want to remove from the machine.

Potential energy is caused by gravity, for example when a load is hoisted to a position and being held in position.

Kinetic energy is caused by movement, for example a centrifuge running at a given speed which we want to reduce or a trolley to be stopped.

The dynamic characteristics of some loads require 4-quadrant operation. A reduction in the stator frequency (and voltage) by the FC allows the motor to act as a generator and convert mechanical energy into electrical energy.

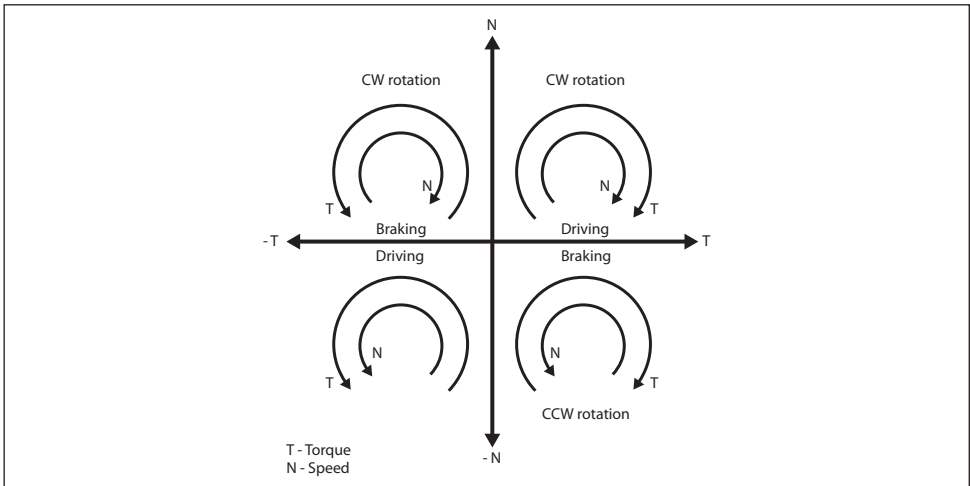

Fig. 3.10 Four Quadrant operation: Clockwise (CW) and Counter Clockwise (CCW)

Motors connected directly to the mains deliver the braking energy straight back to the mains.

If a motor is controlled by a FC, the braking energy is stored in the intermediate circuit of the FC. If the braking energy exceeds the power loss of the FC, the voltage in the intermediate circuit increases dramatically (in some cases exceeding 1000 V DC). If the voltage exceeds the internal voltage limit, the FC is then switched off for self-protection and usually issues an alarm message or error code “over voltage”. Measures must be taken to prevent the FC being tripped if the motor feeds back excessive braking energy.

The following measures are typically used:

- Extend the deceleration ramp time
- Dissipate the energy in the motor. That is, the motor is used as a braking resistor
- The FC is fitted with a “brake chopper” electronic circuit and appropriate braking resistors
- Use of a regenerative braking unit to feed energy back to mains
- Use of FCs with an active rectifier to feed energy back to mains

The first two measures require no additional hardware components. All the other measures do require additional components and must be taken into account at the design stage of the machinery.

3.5.1 Extending Deceleration Ramp

The deceleration ramp time can be extended by the operator by changing the relevant parameter setting. However the operator must judge the load ratios himself.

Example

An attempt to brake a 22 kW motor operated by a FC from 50 Hz to 10 Hz within one second will end up with the FC tripping because the motor, acting as a generator, will feed back too much energy. The user can prevent the FC from tripping by changing the ramp-down time (for example, to 10 seconds).

Alternatively, the modern FC has control functions such as overvoltage control (OVC) that must be enabled to prevent the FC tripping or to automatically extend the ramps. The FC itself determines then the appropriate ramp time. This type of ramp extension automatically takes account of varying load inertias. Care must be taken when this kind of function is used on machines with vertical or horizontal movement (such as hoists, lifts, and portal cranes) as extending the ramp time does also mean that the traveling distance will be prolonged.

3.5.2 Motor as a Braking Resistor

Manufacturers use various methods for using the motor as a braking resistor. The basic principle is based on re-magnetising the motor. Every manufacturer gives its method a different name, such as AC brake, flux brake, or compound braking. This type of braking is not recommended for highly dynamic applications (such as hoists or lifts) because the more frequent the braking, the hotter the motor becomes and consequently it can fail to perform as expected.

3.5.3 Brake Chopper Circuit (Brake Module) and Resistor

The circuit essentially consists of a transistor (for example, IGBT) that eliminates the excess voltage by “chopping” it and sending it to the connected resistor. The control circuit must be fed with the appropriate information during commissioning that a braking resistor is connected. The control circuit can also check whether the resistor is still in working order. Typically it must be specified if an FC is equipped with a brake chopper or not, at the point of ordering.

Above a certain power level, the use of a braking module and resistor will cause heat, space and weight problems.

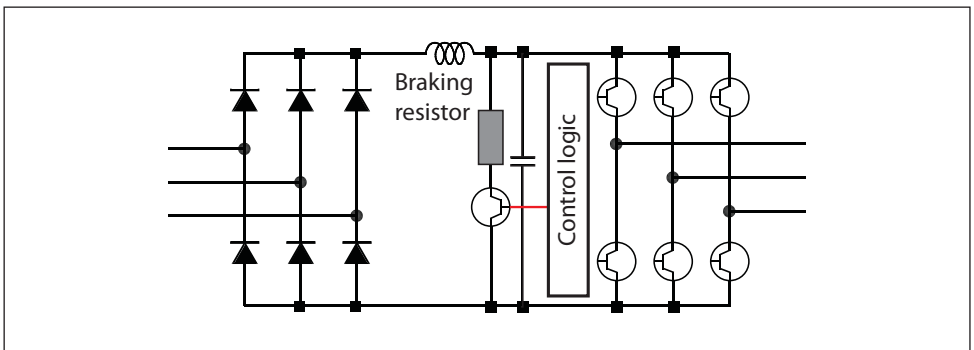

Fig. 3.11 Brake “chopper” and resistor

3.5.4 Use of a Regenerative Braking Unit

If the load often generates a great deal of regenerative energy, it may be useful to use a fully-regenerative braking unit.

If the voltage in the intermediate circuit rises to a given level, the DC voltage in the circuit is fed back to the mains, synchronously in both amplitude and phase, by an inverter.

This feedback of energy can be accomplished by:

- FCs with an active rectifier. In this FC type, the rectifier can transmit energy from the intermediate DC circuit to the power supply
- External regenerative braking units integrally connected to the intermediate circuit of one or more FCs, monitor the voltage in the intermediate circuit.

Fig. 3.12 Regenerative braking unit shows a simplified version of the operating principle.

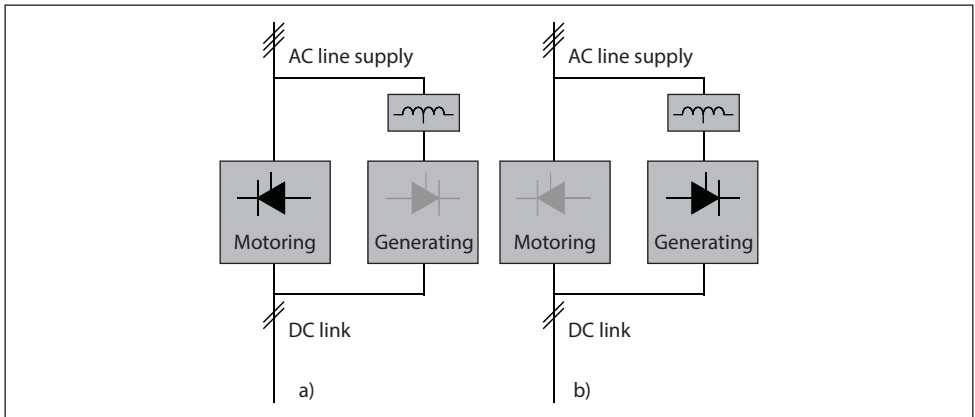

Fig. 3.12 Regenerative braking unit: motoring phase control on (a), motoring phase off (b)

For evaluation when it makes economic sense using these kind of devices please refer to chapter 4 Saving Energy with Frequency Converters.

3.6 Static Brake Operation

The FC has several functionalities for locking or coasting the motor shaft, such as:

- Coasting to stop
- DC brake
- DC hold
- Electromechanical brake

The last three of these functions can typically only be performed after a stop command has been issued. This is often misunderstood in practice. It is important to note that a reference value of 0 Hz does not function as a stop command.

In general, do not use these functions when the direction of rotation is reversed.

3.6.1 Coasting to Stop

With the motor coasting, the voltage and frequency are immediately interrupted (0 V/0 Hz) and the motor is “released”. As the motor is no longer energised, it will typically spin down to zero speed. Depending on the speed and inertia of the load this can take from seconds to hours (for example, for huge separators).

3.6.2 DC Braking

A DC voltage across any two of the three motor phases is used to generate a stationary magnetic field in the stator. This field cannot generate high braking torque at the rated frequency. The braking power remains in the motor and may cause overheating.

Three parameters are required for DC braking:

- The frequency at which the brake should be activated. A frequency value below 10 Hz is recommended. Use the motor slip frequency as a guide. A frequency of 0 Hz means that the function is disabled
- The braking current used for holding the motor shaft. The recommendation is not to exceed the rated current of the motor in order to prevent possible thermal overload
- The duration of DC braking. This setting depends on the application

3.6.3 DC Hold

Unlike the DC brake, the DC hold has no time limit. Otherwise the above recommendations for the DC brake apply. This function can also be used when “auxiliary heating” is implemented for a motor placed in a very cold environment. As constant current flows through the motor, do not exceed the rated motor current. This minimises the thermal load on the motor.

3.6.4 Electromechanical Brake

The electromechanical brake is an aid for bringing the motor shaft to a standstill. This can be controlled from the FC by means of a relay and there are various possible control options.

It is important to establish when the brake can be released, as well as hold the motor shaft.

Some of the points to consider are:

- Motor pre-magnetisation, meaning a minimum amount of current is needed
- The frequency at which activation or deactivation occur
- Reaction times (delay times) of the relay coils

For critical applications such as hoists or lifts, once the start command has been given the brake may only be released after ensuring optimum pre-magnetisation of the motor; otherwise the load could fall. A minimum current, usually the magnetising current, should flow first to ensure that the motor cannot drop the load.

3.7 Motor Heating and Thermal Monitoring

Energy lost in motors during operation will warm up the motor. If the motor is heavily loaded, some cooling is needed. Depending on the system, motors can be cooled in different ways:

- Self-ventilation
- Forced air cooling
- Liquid cooling

To maintain the motor lifetime, keep the motor within the specified temperature range. The most common cooling method is self-ventilation, where the motor is cooled by a fan mounted on the shaft.

The temperature conditions of the motor are subject to two influences:

- When the speed decreases, the cooling air volume also decreases.
- When a non-sinusoidal motor current is present, more heat is generated in the motor.

At low speeds the motor fan is not able to supply enough air for cooling. This problem arises when the load torque is constant throughout the control range. This lower ventilation determines the permissible level of torque during continuous loading.

When the motor runs continuously at 100% rated torque, at a speed which is less than half the rated speed, the motor requires extra air for cooling. This extra air cooling is indicated by the shaded areas in Fig. 3.13 T/N characteristics with and w/o external cooling.

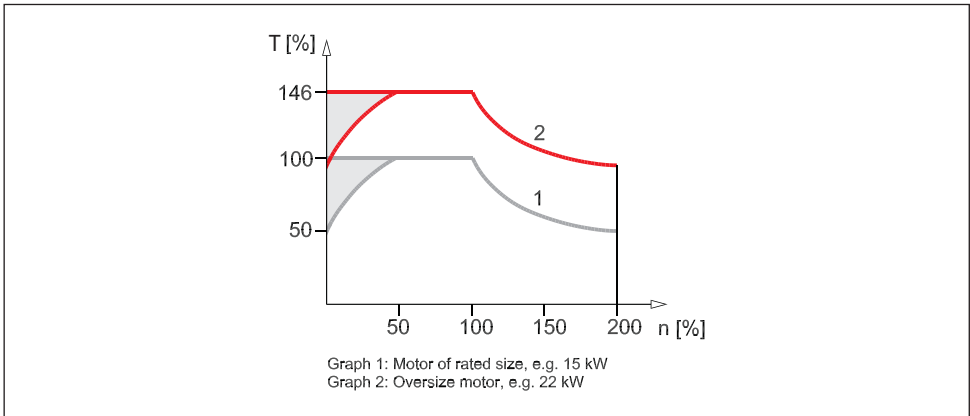

Fig. 3.13 T/N characteristics with and w/o external cooling

Alternatively, instead of providing extra cooling, it is possible to reduce the motor load ratio. To reduce the motor load ratio, select a larger motor. However, the FC specification imposes limits on the size of motor that can be connected.

When the motor current is non-sinusoidal, the motor receives harmonic currents that increase the motor temperature, as shown in Fig. 3.14 Maximum continues torque and current shape relation. The magnitude of the harmonic currents determines the amount of heat increase. Therefore, do not operate a motor continuously at 100% load when the current is non-sinusoidal.

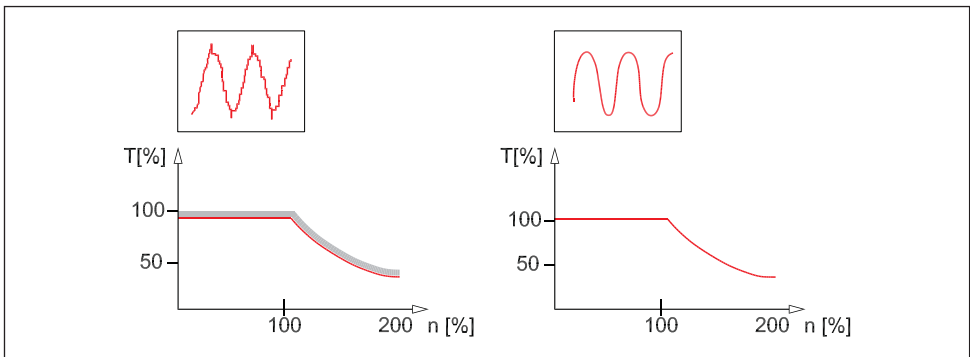

Fig. 3.14 Maximum continues torque and current shape relation

When the application predominantly requires low speeds, an additional fan to cool the motor is recommended to ensure full torque. However, the fan should be powered from a separate supply and should not be connected to the output of the FC. As an alternative to air, liquid can be used for cooling the motor. Liquid cooling is typically implemented in special motor designs.

Two temperature monitoring methods are implemented in the FC, in order to protect the motor:

Calculation:

The motor temperature is calculated based on a mathematical motor model

Measurement:

Thermistors or PTCs placed inside the motor can be connected to the device, to monitor temperature

If motor overheating occurs, the remedial action required is programmed to fit the application needs.

3.8 Functional Safety

Functional safety defines protection against hazards caused by incorrect functioning of components or systems. In Europe, functional safety falls under the Machinery Directive 2006/42/EC.

The Machinery Directive describes the purpose of functional safety as follows:

“Machinery must be designed and constructed so that it is fitted for its function, and can be operated, adjusted and maintained without putting persons at risk when these operations are carried out under the conditions foreseen but also taking into account any reasonably foreseeable misuse thereof.”

Depending on which application standard has to be fulfilled, the system must reach a defined safety level. The required safety level is defined through the risk assessment.

The Machinery Directive refers to different standards, according to the safety level required.

Safety Level	Abbreviation	Standard
Category	Cat	EN 954-1
Performance Level	PL	EN ISO 13849-1
Safety Integrity Level	SIL	IEC 61508 / IEC 62061

The European functional safety regulations are comparable to many others around the globe. For example, in North America the OSHA (Occupational Safety and Health Act) applies, and in Canada the CCOHS (Canadian Centre for Occupational Health and Safety) provide the framework for applying safety measures. Although the relevant standards differ between the various regions, the safety principles are closely related.

In general it is common to use abbreviations in the different legislative frameworks and the standards to describe the safety function and the safety level.

Function	Description	Illustration
Safe Torque Off STO	The motor does not get energy to produce torque/ rotation. This function complies to stop category 0 according to IEC 60204-1.	
Safe Stop 1 SS1	A controlled stop, in which the drive elements of the machine are kept energised in order to stop it. The power is only disconnected when standstill has been reached. This function complies to stop category 1 according to IEC 60204-1.	
Safe Limited Speed SLS	A safe state of speed is called Safe Limited Speed. This ensures that a machine runs at a constant safe speed. If it runs faster a Stop function will be activated	
Safe Maximum Speed SMS	Ensures that the machine does not run at a higher level than a defined maximum speed. It prevents machine damage and reduces hazards. Function-wise it is the same principle as SLS	
Safe Speed Monitor SSM	SSM monitors for zero speed and sets an output signal high if zero speed is reached. This function can be used to unlock doors or simply to display that the machine is in standstill.	

Table 3.15 General FC safety functions and their functionality

The FC has several additional functional safety functions:

- SOS Safe Operating Stop
- SS2 Safe Stop 2
- SDI Safe Direction
- SBC Safe Brake Control
- SAM Safe Acceleration Monitor
- SLP Safe Limited Position
- SCA Safe Cam
- SLI Safe Level increment
- SSR Safe Speed Range
- SBT Safe Break Test

SISTEMA

Independent Software tools such as SISTEMA (Safety Integrity Software Tool for the Evaluation of Machine Applications) help the machine builder to make all the calculations of the safety application.

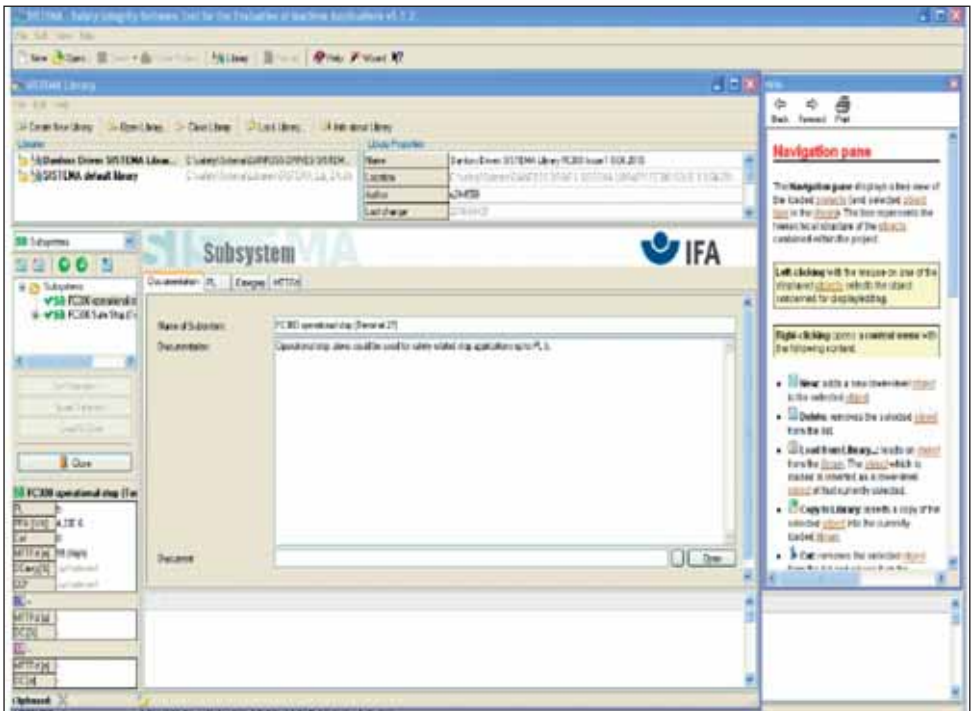

Fig. 3.16 Screenshot of the SISTEMA start page

The SISTEMA software utility provides support to developers and testers of safety-related machine controls, in evaluation of safety in the context of ISO 13849-1. The tool enables modelling of the structure of the safety-related control components based upon the designated architectures. This modelling enables automated calculation of the reliability values with various levels of detail, including that of the attained Performance Level (PL).

Relevant parameters are entered step-by-step in input dialogs, for example:

- risk parameters for determining the required performance level (PLr)
- the category of the SRP/CS
- measures against common-cause failures (CCF) on multi-channel systems
- average component quality (MTTFd)
- average test quality (DCavg) of components and blocks

The impact of each parameter change upon the entire system is reflected immediately in the user interface. The final results are printable in a summary document.

4 Saving Energy with Frequency Converters

4.1 Potential

Electric motors account about 48% of global electrical energy consumption (1). In Industrial applications the ratio is even higher. Depending on the region and the industrial area, 65-75% of electrical energy is used for electric motors. Therefore electrical drive technology holds a great deal of potential for reducing the worldwide energy consumption.

Frequency Converters enable the development and improvement of more energy-efficient motor technologies. Even more beneficial is applying the main reason why FC's were developed: adjustable speed control. Speed control helps to optimise processes and operate motors at optimal speed and torque.

When total potential savings that could be made in a system are defined as 100%, roughly 10% of that potential could be obtained through the use of more efficient components, such as motors. Operation with adjustable speed control offers potential energy savings of approx. 30%. However, the greatest savings (approx. 60%) are to be made by optimising the entire system.

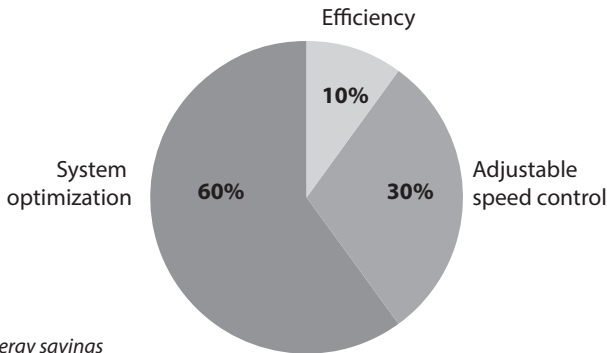

Fig. 4.1 Potential energy savings

If a few key points are taken into consideration, FC's can lead to high energy savings being quickly and easily realised as the majority of applications (approx. 60-70%) are suitable for speed control. In particular, fans and pumps - which cover almost 50% of the applications - are obvious targets because of their huge saving potential.

(1) Source: 2008 – International Energy Agency

4.2 Motor + Frequency Converter Efficiency

The efficiency of a system consisting of a motor operated by a FC can be calculated by multiplying the single efficiencies.

$$\eta_{\text{System}} = \eta_{\text{Motor}} * \eta_{\text{Frequency converter}}$$

Typically FC efficiency curves at two different loads are shown in Fig. 4.2 Efficiency example of frequency converters (A = 100% load / B = 25% load). The efficiency of the FC is high throughout the control range, both at high and at low load levels.

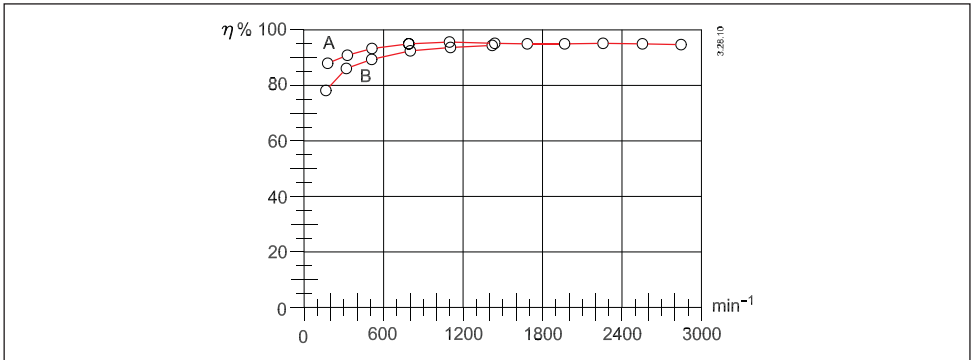

Fig. 4.2 Efficiency example of frequency converters

Beside the economical aspect that high efficiencies of FC’s result in lower energy consumption, the dissipated power that has to be removed from the installation is reduced. This is important if the FC is integrated into a cabinet. If the losses are too high separate cooling devices are required which consume energy as well.

Normal and part load efficiencies of motors are compared to the FC as illustrated in Fig. 4.3 Efficiency example of a 2-pole motor (A = 100% load / B = 25% load).

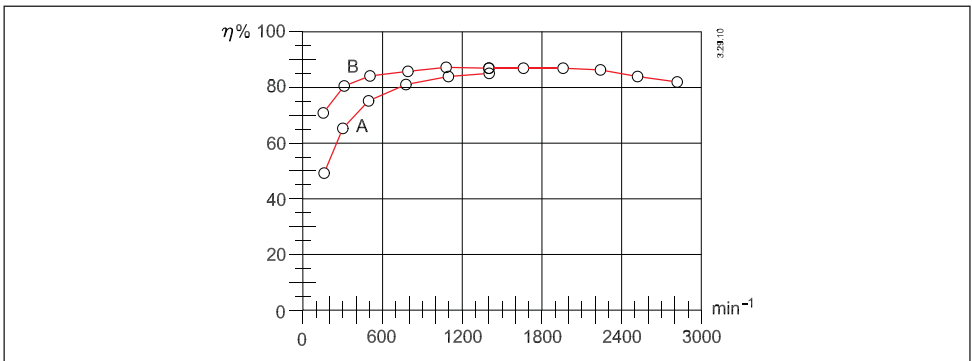

Fig. 4.3 Efficiency example of a 2-pole motor

Consequently the motor has a major influence on the system efficiency (Fig. 4.4 Efficiency example of a frequency converter and motor combination (A = 100% load / B = 25% load)).

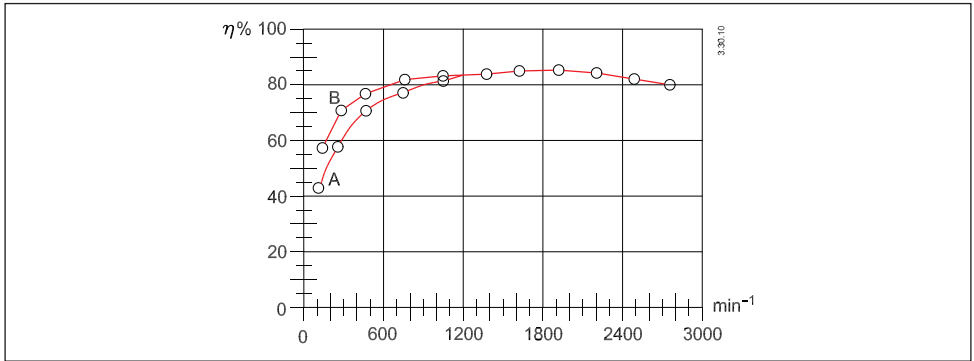

Fig. 4.4 Efficiency example of a frequency converter and motor combination

Although it's common practice to qualify the efficiency of the different components, the accuracy of the value depends strongly on the amount of decimal places used. So often the losses of the different components are provided as well. For example 143W losses is much simpler to handle than 90.467% efficiency (related to 1.5 kW).

4.3 Classification of Energy Efficient Components

Matching individual components to a particular drive system has several advantages over pre-configured systems because this allows the engineer to optimise the system to his requirements. Pre-configured systems are always optimised for general applications and can never fit all. If available, an indicator for the efficiency of components is efficiency classes.

Frequency Converter

The standard EN 50598-2 defines efficiency classes for FC's. As power electronics can have several configurations the classes IE0-IE2 are defined for Complete Drive Modules (CDM) consisting of rectifier, intermediate circuit and inverter (see Fig. 4.5 Definition of CDM and PDS). CDM with ability to feed back e.g. braking energy to the mains are addressed but not covered because they have typically twice the losses.

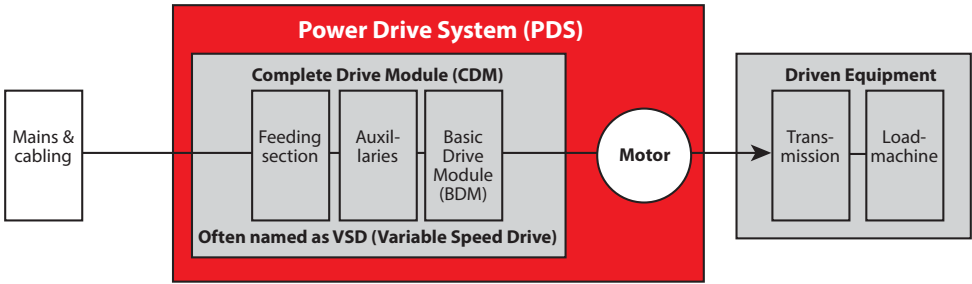

Fig. 4.5 Definition of CDM and PDS

The IE classes are defined in relation to a reference CDM (RCDM). By having the same scale for all power sizes the classes are defined by relative losses. CDM with relative losses in the range of $\pm 25\%$ of the RCDM is classified as IE1. CDM with higher losses are grouped in IE0 while CDM with lower losses are in class IE2 (see Fig. 4.7 Definition of CDM and PDS efficiency classes).

The rating does not reflect the CDM efficiency at lower speed / torque as it's determined at 100% relative speed and 90% relative torque-producing current. For verification the CDM is tested with all included components at a defined test load. Fine tuning or a special test mode is not allowed.

Transmission

Even though the kind of transmission can have a huge impact on the system efficiency, no efficiency classes are defined. The following table gives an indication of typical efficiencies:

Direct driven	100%	Flat belt	96...98%
Spur gear	98%	V-belt	92...94%
Bevel gear	98%	Tooth belt	96...98%
Worm gear	95%	Chain	96...98%

Table 4.1 Typical transmission efficiencies.



Fig. 4.6 One Gear Drive is a direct driven motor which comes without gearbox but provides high torque at high efficiency

Motors

For the power range 0,12-1000 kW, efficiency classes IE1-IE4 for electric motors are defined in the standard IEC/EN 60034-30-1. Although the standard is valid for all motor types some motor constructions (e.g. brake motors) are excluded from the standard. Several countries and regions use the IE class limits to define Minimum Efficiency Performance Standards (MEPS) to restrict the use of low efficiency motors. The efficiency class is related to the nominal operating point of the motor. Efficiencies at full speed but reduced torque must be stated on the nameplate or in the documentation. Limits are different for supply frequencies (50/60Hz) and the number of motor poles (2, 4 or 6 poles).

Classes for motors operated with FC's are under discussion and will be defined in IEC/ EN 60034-30-2.

Frequency Converter + Motor Combination

Efficiency classes for Frequency Converter and Motor combination are defined in the standard EN 50598-2 via an IES rating. Similar to the CDM, the classes of the so called Power Drive System (PDS), which is the motor + FC combination (see Fig 4.5 Definition of CDM and PDS), are related to a reference system (see Fig. 4.7 Definition of CDM and PDS efficiency classes). PDS with 20% higher losses than the reference are in class IE0 while systems with 20% lower losses are in class IES2.

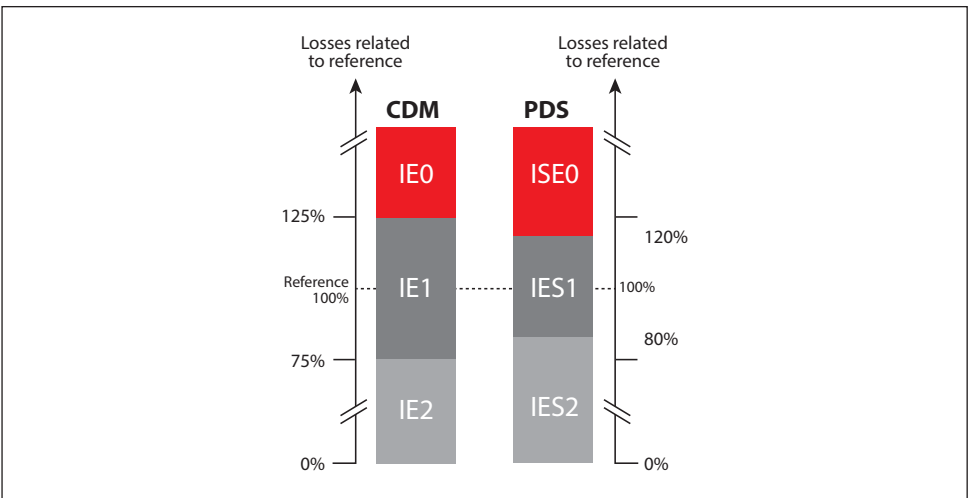

Fig. 4.7 Definition of CDM and PDS efficiency classes

The classification is made for 100% relative speed and 100% relative torque. If the FC is designed for a shorter cable or it's directly mounted on the motor where shorter

cable can be used this must be stated in the documentation. In general all kind of optimisations are possible as long they are noted in the documentation. Consequently comparing two PDS ratings is difficult because they will most likely have different bases.

The IES class for FC and drive combinations illustrates the difficulty in optimising a system and that all components must be carefully selected, in order to optimise the application. The difference between pre-configured and non-optimised free combined systems will most often be minor, but matching different components generally allows finer adjustment to the machine, giving the machine builder a competitive advantage.

4.4 Energy Efficient Motor Start

The energy for starting a motor can be split into 3 major parts:

- Energy required for operating the load
- Energy required for accelerating the load and the motor
- Losses in motors and control

The simplest way for starting a motor is to connect the motor direct on line (DOL) but this is also an inefficient solution. The motor will have high losses when starting due to the huge slip when applying the voltage. While accelerating the motor, the slip and hence the losses are reduced.

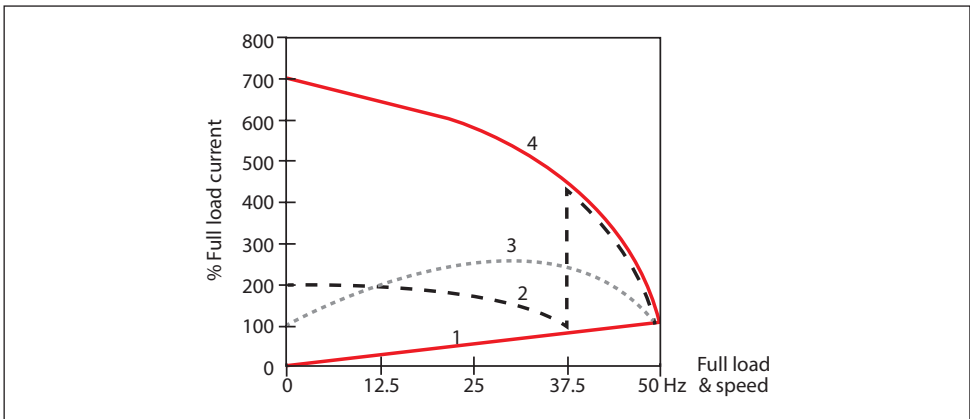

Fig. 4.8 Typical motors currents curves started by (1): Frequency converter at VT load (2): star-delta starter (3): Softstarter (4): direct on line (DOL)

Softstarters can be used which adjust the motor voltage like Star/Delta starters, but linearly. The device increases the voltage until a programmed current limit is hit. The limit is application-dependent, typically in the range of 300-500% FLC. While the motor is accelerating the current drops and the device increases the voltage further. This sequence continues until the mains voltage level is applied to the motor.

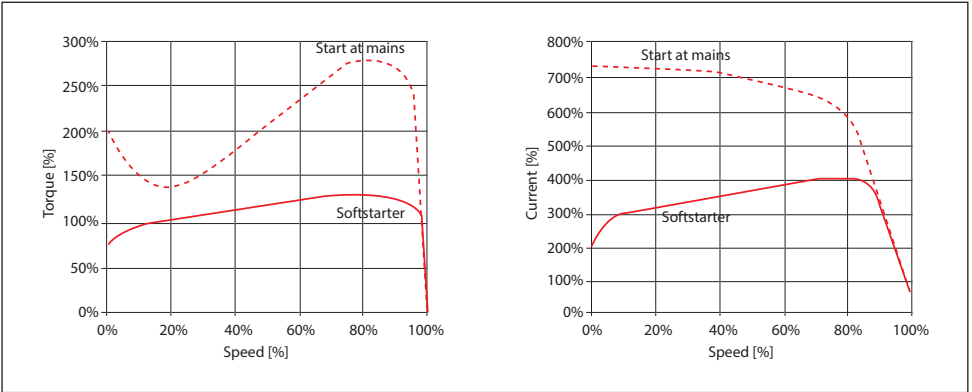

Fig. 4.9 Comparison motor start direct on mains with motor started by a softstarter (400% current limit)

For minimising the losses Softstarters are typically operated in by-pass after the motor has been started. During the starting phase the losses are approx. 4.5 W per A.

The most efficient way for starting a motor is the use of FC's. As voltage and frequency are controlled the slip and hence the losses are reduced. Using a by-pass like on Softstarters is possible but seldom used.

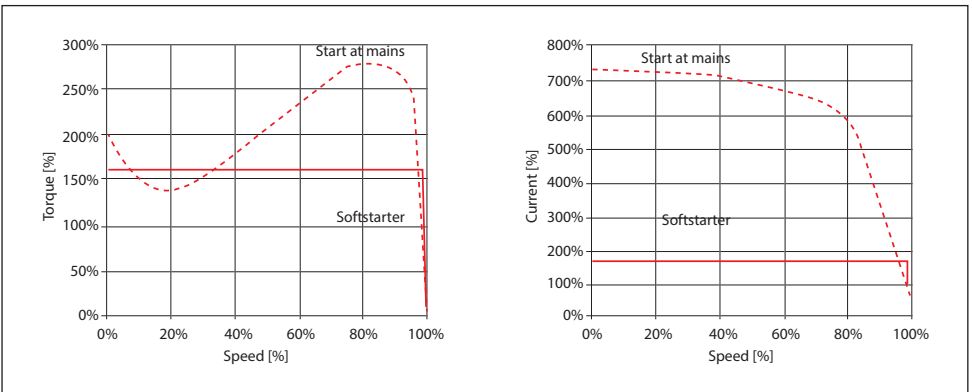

Fig. 4.10 Comparison motor start direct on mains with a motor started by a frequency converter at 160% overload

Principle torque and current curves for starting a motor with constant load direct on mains, by a softstarter and by a frequency converter are shown in Fig. 4.9 Comparison motor start direct on mains with motor started by a softstarter and Fig. 4.10 Comparison motor start direct on mains with a motor started by a frequency converter at 160% overload. The curves will look different with different loads.

4.5 Energy Efficient Motor Control

All motors operate by applying the correct voltage at a given frequency. A rotating shaft does not mean, however, that the motor is operating efficiently. For controlling a motor, a control algorithm (U/f, voltage vector, flux vector,...) and a control strategy are required. That both components must suit a motor type can easily be seen with motors using permanent magnets. For energy-optimum operation the controller must match the supply voltage waveform as closely as possible to the waveform of the back EMF. Block commutation is used for trapezoidal back EMF and sine commutation for sinusoidal.

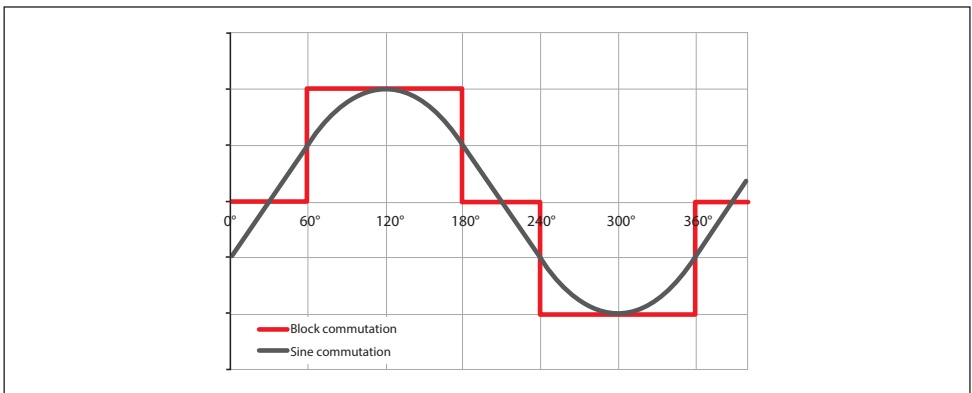

Fig. 4.11 Block vs. Sine-wave commutation

Block commutation is known to have some disadvantages like torque ripple and excessive noise. However both technologies are comparable when it comes to efficiency.

Control strategies which are often used in different control algorithms are:

Constant Torque angle

Maximum torque is created when the torque angle is kept constant at 90° . The constant Torque angle strategy keeps the angle constant by controlling the rotor d-axis current to zero while leaving the current vector on the y-axis.

Maximum Torque Per Ampere

This strategy minimises stator current magnitude for a required torque while considering reluctance torques. Variations in inductances during operation must be considered to obtain best results.

Constant Unity Power Factor control

The angle between current and voltage vector is kept constant under this strategy so the apparent power rating of the inverter can be reduced.

In addition FC's provide extra functionalities for reducing the magnetic field strength at reduced load. This can be done by special U/f characteristics or by Automatic Energy Optimization (AEO) functions.

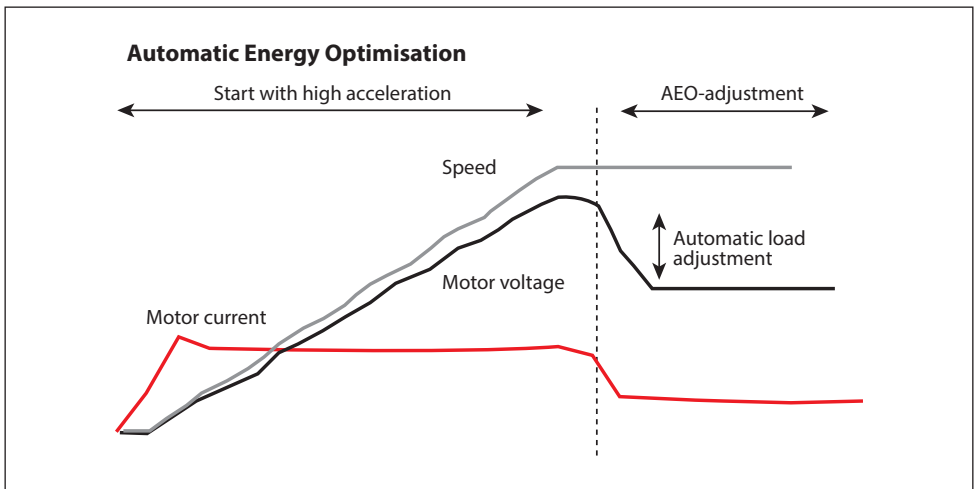

Fig. 4.12 Automatic Energy Optimisation

Automatic adjustments take place after the application reaches a steady state. The applied control strategy reduces the magnetisation level and thus the energy consumption. An optimised balance between energy saving and having enough magnetisation for sudden load peaks must be given to ensure reliable operation. See fig 4.12 Automatic Energy Optimisation.

The average energy saving potential for small to medium-sized drives is 3 to 5 % of the rated motor power during operation at low loads. As a very important side-effect, the motor runs almost noiselessly at low loads – even at low to medium switching frequencies.

4.6 Load over Time

Every component in a system has some losses, so adding components to a system should be avoided if possible. This applies also to FC's. Adding a unit to a motor which has to run all day at full load and full speed will only result in additional losses. But as soon as reducing speed and torque make sense to the application, the use of a FC will reduce the energy consumption. The achievable savings depend on the load profile over time, the torque characteristics and the efficiency of the motor and drive system at the given part load points.

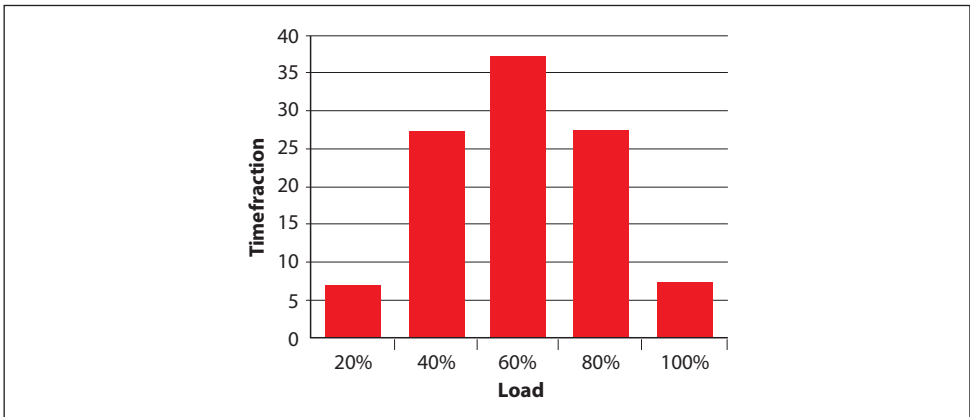

Fig. 4.13 Load over Time fraction diagram indicates how long a load is operated at part load

Part load is used in two different contexts. When a motor is operated from the mains, the feeding motor frequency is fixed and the speed only varies with load. When the motor is operated by a FC, part load describes torque at a certain speed where the torque characteristic is given by the application. Actually the majority of applications are operated at part load. This is also true for mains driven motors as they are typically oversized.

4.6.1 Applications with Variable Torque

Variable torque applications often involve pumps and fans. However, a distinction has to be made in the case of pumps. Although the most popular types of centrifugal pump have a quadratic torque characteristic, eccentric, vacuum or positive displacement pumps have a constant torque characteristic.

The energy saving potential of pumps and fans is very high as these machines follow the affinity laws.

$$\frac{Q_1}{Q_2} = \left(\frac{n_1}{n_2}\right) \text{ Flow is proportional to speed}$$

$$\frac{H_1}{H_2} = \left(\frac{n_1}{n_2}\right)^2 \text{ Pressure or head is proportional to square of speed}$$

$$\frac{P_1}{P_2} = \left(\frac{n_1}{n_2}\right)^3 \text{ Power is proportional to cube of speed}$$

The flow Q increases linearly with increasing speed (RPM), while the pressure/head H increases quadratically and the power consumption P increases cubically. In theory a reduction in speed of 20% results in an energy reduction of 50%.

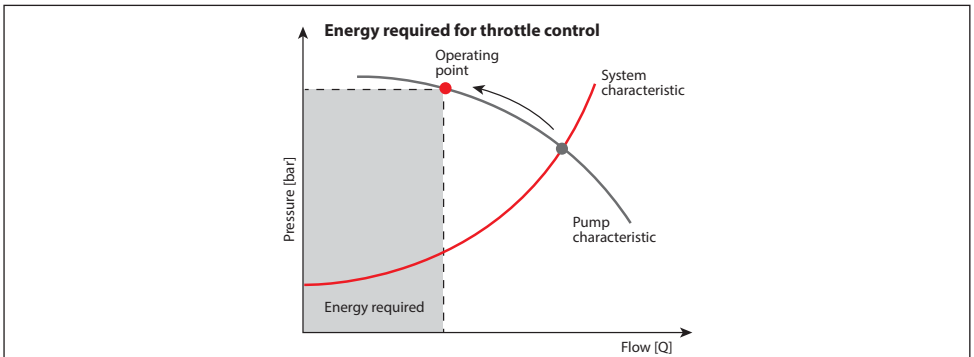

Fig. 4.14 Energy required in a variable torque pump application for throttle control

In many fan and pumps systems, swirl flaps, dampers or throttles are used for controlling the flow of the system. If a centrifugal pump is controlled using a throttle valve, throttling moves the machine’s working point along the pump characteristic. The reduction in energy requirement achieved is minimal compared with the pump’s nominal operating point.

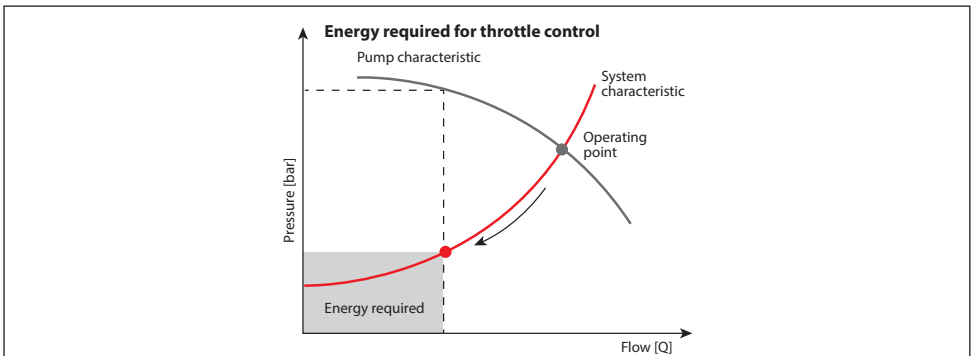

Fig. 4.15 Energy required in a variable torque pump application for speed control

If a fan/pump is speed-controlled, the operating point moves along the system characteristic. This moves the unit out of its best efficiency point and efficiency will typically decrease slightly but the energy saving due to the reduced speed is still much higher compared to throttle or other mechanical controls. In real applications, the achieved energy savings will differ from the theoretical because losses in piping and duct-work result in a basic load and thus additional losses.

In pump applications often a minimum speed (application and pump type/make-related) is required for avoiding sedimentation of solids and ensuring sufficient lubrication of the pump. If the range between minimum speed and speed for the maximum required power is too big the system can be cascaded. When pumps are cascaded, one speed-controlled pump covers the base load. If consumption increases, the frequency converter will switch in more pumps sequentially. The pumps accordingly operate at maximum efficiency whenever possible. Pump control ensures that the system is always as energy-efficient as possible. In some applications more than one pump is speed controlled. Cascades can be used in a similar way for other applications like fans or compressors.

4.6.2 Applications with Constant Torque

Applications with constant torque are applications for which the load is typically not significantly altered by the speed. This includes conveyor belts, hoists and mixers.

If, for example, an engine block is positioned on a horizontal conveyor belt, the weight of that engine block will not change, regardless of the conveyor belt speed. The torque required to move this engine block is always the same. Of course, the friction and acceleration torque would change according to the operating conditions, but the torque needed to move the load still remains constant.

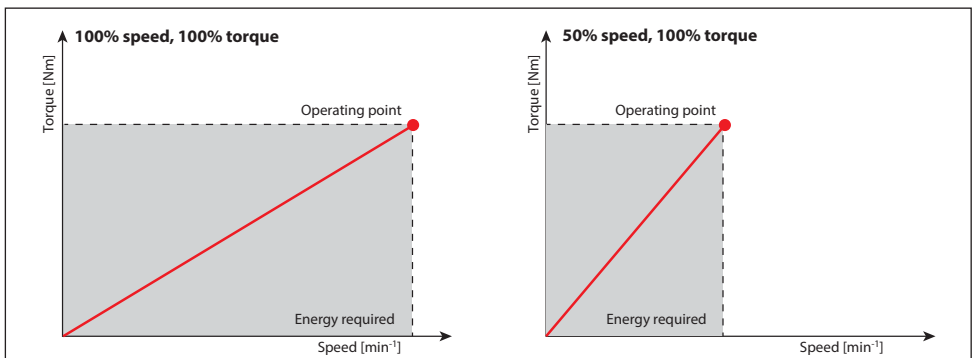

Fig. 4.16 Energy required at different speed and loads

The energy required by such a system is proportional to the required torque and the speed of the motor.

$$P \sim T \times n$$

If the speed can be reduced with a constant load as is the case in refrigeration cycles, one of the direct results will be energy savings. In other constant load applications, reduced speed will not have a huge impact. If, for example, the speed of a conveyor belt is reduced, the energy required to transport the goods from A to B stays approximately the same as the distance stays the same. Small savings are achieved through such factors as reduced frictional loss or optimised acceleration. Nevertheless the use of speed control in constant torque applications is continuously increasing because of the benefits to the process itself.

4.7 Life Cycle Costs

Potential ways to save energy can be found in almost all sectors, like building services, conveyor belt systems or chemical processes.

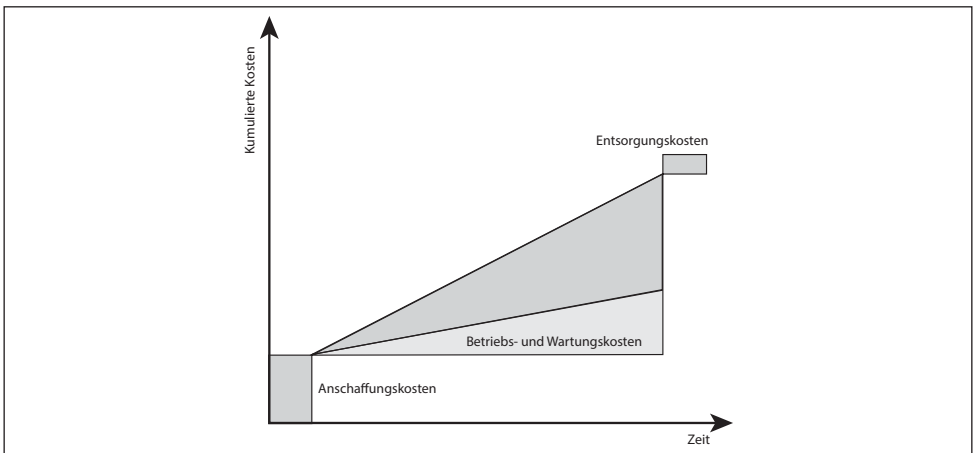

Fig. 4.17 Initial costs usually account for only approximately 10% of overall life cycle costs. The higher initial costs of an energy-saving device often pay for themselves in next to no time

4.8 System Savings

Regardless of whether the energy efficiency of a new or existing process/machine shall be improved, the whole system must always be considered. Existing installations have the advantage that measurements can be made to determine the losses, creating a benchmark as to whether improvements to the system are working as expected

Fig. 4.18 Overview of motor drive system with various accessories – illustrates a drive system operating a conveyor showing the majority of components which can be found in a drive system.

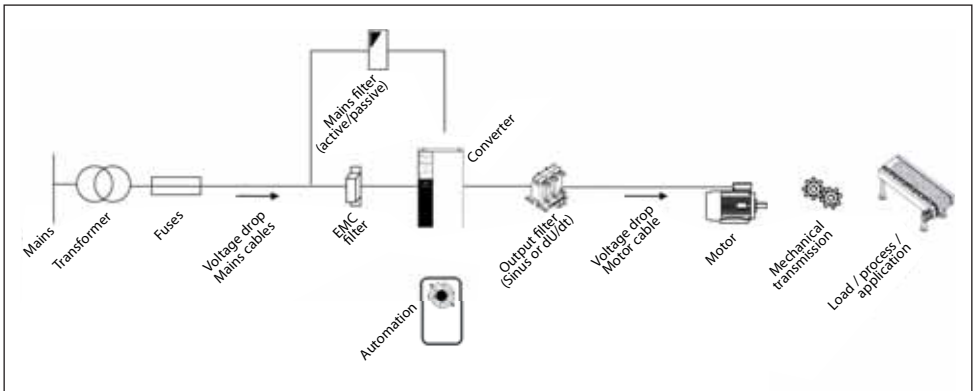

Fig. 4.18 Overview of motor drive system with various accessories

The setup and the whole dimensioning of the system depend on the application (transmission, motor, output filter and motor cable) and its environment (EMC filter, output filters, cables, mains, climate, etc.). Therefore the engineering and the energy saving assessment should always start with the application assessment. It makes no sense to select one or two highly- efficient components if they have a negative impact on the system efficiency. This is illustrated in the following example.

Before deciding to make an investment, it is necessary to examine not only the technical, but also the commercial and logistical aspects, so that measures which are not cost-effective, or which are counter-productive, can be avoided or minimised. TCO (Total Cost of Ownership = total costs within a certain timeframe) and LCC (Life Cycle Costs = costs incurred within a lifecycle) are methods used for such an evaluation.

A life cycle cost analysis includes not only the procurement and installation costs, but also the costs of energy, operation, maintenance, downtime, the environment and disposal. Two factors – energy cost and maintenance cost, have a decisive effect on the life cycle cost.

$$LCC = C_{ic} + C_{in} + C_e + C_o + C_m + C_s + C_{env} + C_d$$

C_{ic} = initial capital cost (procurement cost)

C_{in} = installation and commissioning costs

C_e = energy cost C_s = downtime and lost production costs

C_o = operating cost C_{env} = environmental cost

C_m = maintenance cost C_d = decommissioning and disposal costs

One of the biggest factors in the life cycle cost formula is the energy cost. Higher Investments which bring the energy consumption down will, in many applications, have only a minor impact

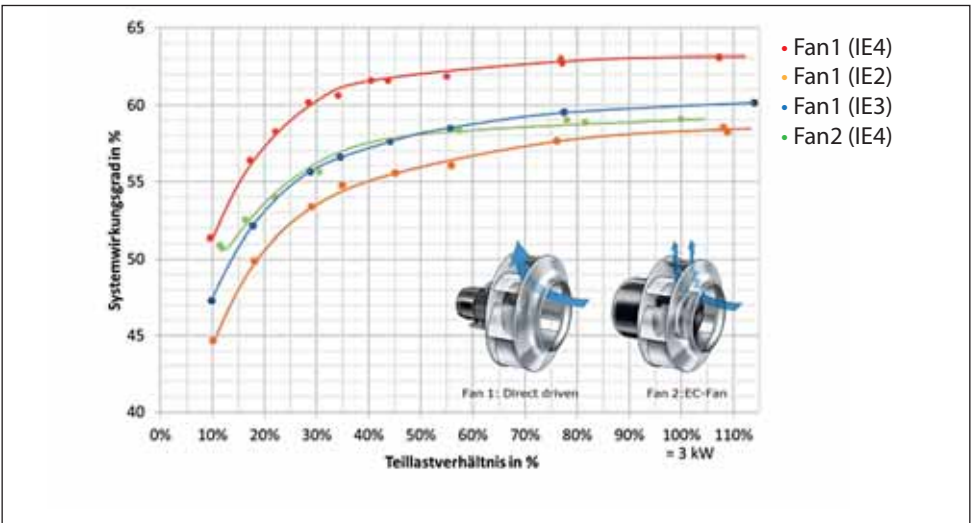

Fig. 4.19 Measurement of different ventilator fan systems with 3 kW acc. DIN EN ISO 5801 in same ventilation unit

Fan 1 is a direct-driven type and the system efficiency increases when more efficient motors (better IE class) are used. Fan 2 is EC fan with a high-efficiency motor. The lower system efficiency results from the fan design. As the motor is placed as hub in the EC fan the air flow is disturbed and the system efficiency decreases.

The majority of applications are suitable for speed control but it must be validated case by case. For example, not all compressors are designed for speed control and their minimum and maximum speed limits must be respected and too short or too fast ramp times can be critical.

4.9 Using Regenerated Power

Electric motors can be operated in generative mode when e.g. an asynchronous motor runs faster than its synchronous speed. This can happen when decelerating the motor from one speed to another. In most cases, the user will then channel the generated energy into braking resistors which will convert it into heat. In practice, there are two common technical solutions to feed this energy back into the grid or to supply it to other machines:

Intermediate circuit coupling

Some FC's are able to interlink their DC intermediate circuit with the intermediate circuits of other devices. This enables other devices to be directly supplied with regenerated energy. However, there are some constraints that should be noted. For example, users should always ensure that, if one device short circuits, it will not damage the others. Users must, of course, also take note of what happens if all coupled devices emit regenerated energy at the same time.

Power feedback (regenerating)

Active Front End or Active Infeed Converters can feed regenerated power back into the grid. If the use of regenerative devices is economic depends on 3 factors:

Available energy

Most applications generate energy during deceleration processes. This energy decreases continuously during the speed change. Theoretically, the regenerated energy is equal to 50% of the difference between the energy which is in the system when starting and stopping the deceleration, but in reality this figure lies somewhere between 10 and 20%. Exceptions to this are seen in lifts, cranes and hoists. Furthermore the nominal motor performance is not equal to the regenerated energy as oversizing of motors is common practice. Only very rarely does the nominal motor power hit exactly the required application power.

Losses

Motor, cables, gears and even the AIC itself create losses which reduce the energy which can be fed back into the grid.

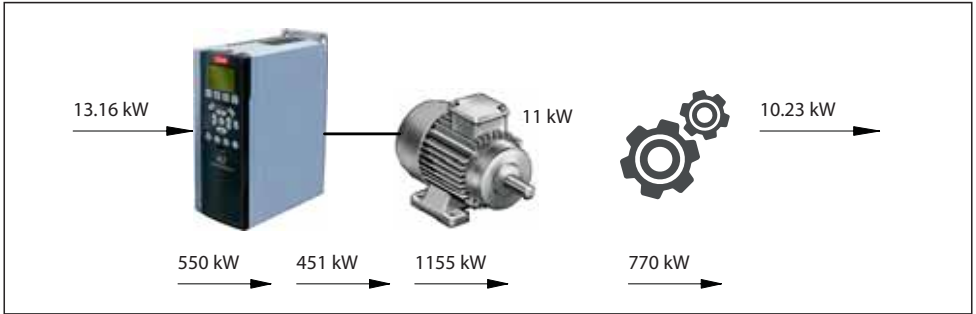

Fig. 4.20 System losses during motor operation

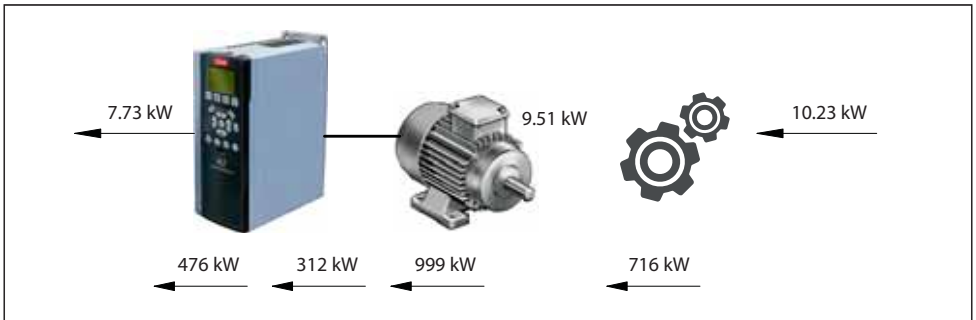

Fig. 4.21 System losses at regenerative operation

The losses caused by the AFE or AIC itself are much higher than for a standard FC due to the active rectifier whose losses can be twice as high in operation but also in standby. Depending on the construction, regenerative FC's without the necessary filters create more harmonic currents, which can also lead to higher losses in the grid.

Occurrence

The more often the motor is operated in regenerative mode the more energy is fed back to the grid. Therefore situations during a load cycle where energy is generated must be considered. As well as the load cycle itself, the number of load cycles defines the resulting amount of energy for a given time.

The majority of applications will never justify an investment in AIC which are typically more costly than standard inverters. The example of an elevator illustrates that AIC can also have a negative impact even though elevators are usually seen as the optimal application for AIC.

Application: Elevator in residential building
 Load: 1100 kg
 Operation: 1h per day
 $\eta_{gear}=90\%$ $\eta_{Hoist\ way}=80\%$ $\eta_{Motor}=88\%$ (IE2) $\eta_{AIC}=95\%$ $\eta_{VSD}=97\%$
 Standby losses: AIC = 40 W, VSD = 40W

Result:

	AFE/AIC	Standard VSD
Losses motor per year	47 kWh	34 kWh
Losses standby per year	336 kWh	168 kWh
Generated Energy per year	170 kWh	-
Balance	213 kWh	202 kWh

Table 4.2 Energy consumption for elevator example

The values used in the example are very conservative. It may be surprising but one hour operation is very high for an elevator in a typical residential building. Nevertheless the energy balance is negative. This illustrates that applications where potentially AIC can be used require special consideration.

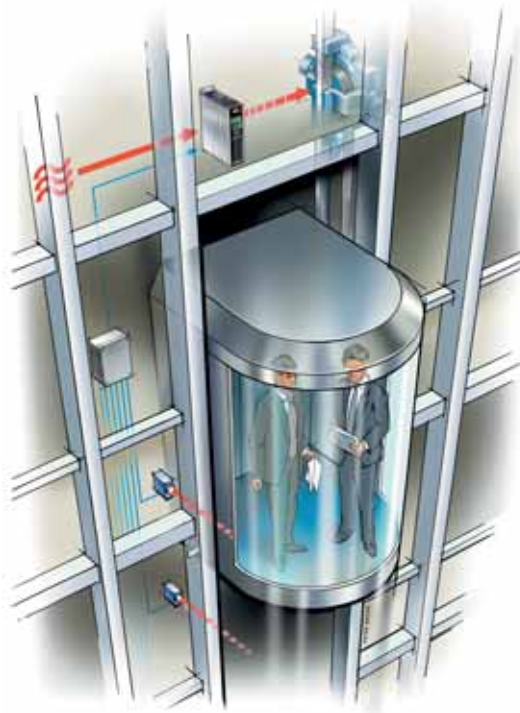

5 Electromagnetic Compatibility

5.1 EMI and EMC

Electromagnetic interference (EMI) is the degradation of the performance of equipment caused by electromagnetic disturbance.

An example of EMI is when random dots and lines (commonly called “snow”) appear on the screen of a television when a vacuum cleaner is operated in the same room. In this example the vacuum cleaner is the source of interference and the TV set is the victim equipment.

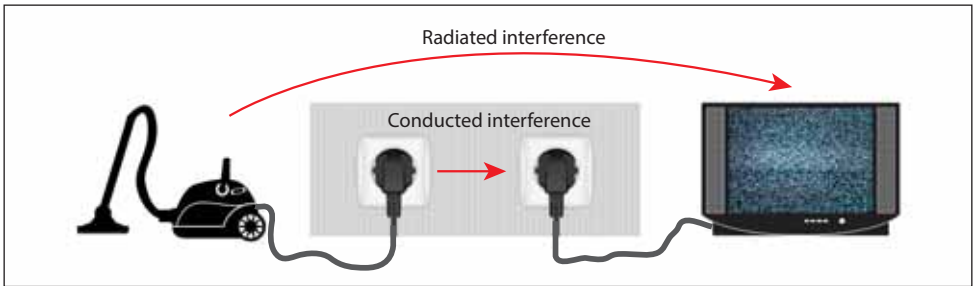

Fig. 5.1 Difference between radiated and conducted interference

Electromagnetic noise can be propagated through conductors (conducted interference) or through electromagnetic waves (radiated interference). There are four interference coupling mechanisms:

- Galvanic coupling occurs when two circuits (noise source and victim) share a common electrically conductive connection
- Capacitive coupling (also known as electric coupling) occurs when two electric circuits have a common reference and the noise couples between two conductors through parasitic capacitances
- Inductive coupling (also known as magnetic coupling) occurs when the magnetic field around a current carrying conductor is induced in another conductor
- Electromagnetic coupling occurs when the noise source radiates electromagnetic energy through a conductor that acts as a transmitting antenna. The victim circuit receives the disturbance through a conductor that acts like a receiving antenna

There can be various sources of electromagnetic interference, such as:

- Natural sources such as lightning
- Electrical equipment which is not intended to produce electromagnetic radiation: for example a frequency converter or power supply

- Electrical equipment intended to produce electromagnetic radiation: for example a portable radio transmitter

The art of EMI troubleshooting consists of identifying the noise source, coupling mechanism and reducing the interference coupling to an acceptable level.

When a piece of equipment or system is able to function satisfactorily in its electromagnetic environment without introducing intolerable disturbances in that environment, it is called electromagnetic compatibility (EMC). It is important to note that the definition of EMC contains two aspects:

- Immunity: the ability of equipment to function in the presence of some level of electromagnetic interference
- Emission: the unintended emissions from equipment need to be limited to a tolerable level

The difference between the emission margin and the immunity margin is called compatibility gap.

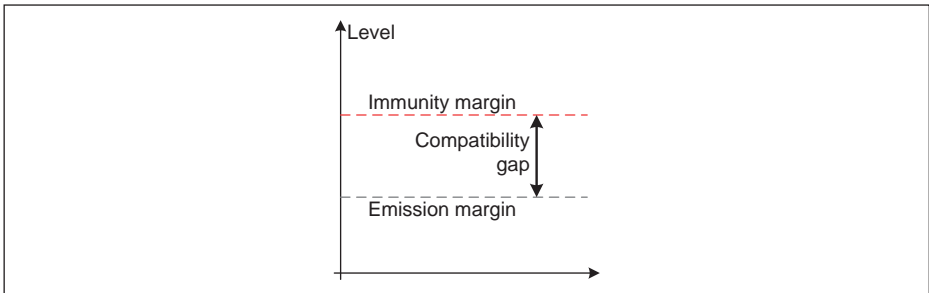

Fig. 5.2 Explanation of compatibility gap

RFI or EMI?

The term radio frequency interference (RFI) is often used interchangeably with EMI. RFI is an older term and refers to the interference of the reception of radio signals (radio, TV, wireless communication). EMI is a newer term which refers broadly to interference of any electrical equipment, including Frequency Converters.

Common-mode and differential mode

When referring to conducted interference the terms common-mode (CM) and differential-mode (DM) are often used.

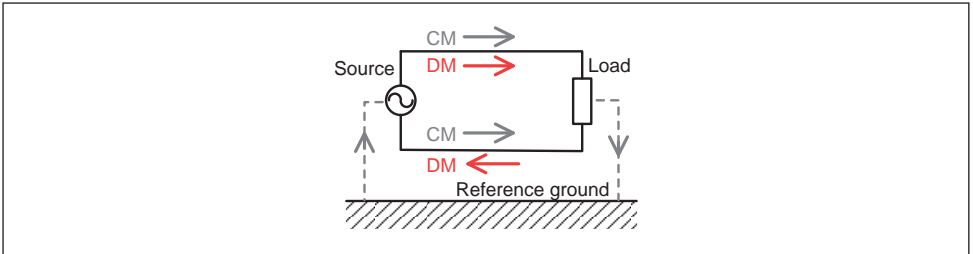

Fig. 5.3 Common-mode and differential-mode

The differential mode (DM) noise is conducted on both lines of the current loop in opposite directions, in series with the desired signal. The common-mode (CM) noise is conducted on both lines in the same direction and its return path is through a common reference ground.

5.2 EMC and FC's

Emission

FC's involve fast switching of voltages (high du/dt rates) in the thousands of V/μs range with amplitudes in the 500 V – 1000 V range FC's (depending on supply voltage) and high current levels. This makes FC a potential source of EMI and their EMC-correct installation needs to be carefully followed.

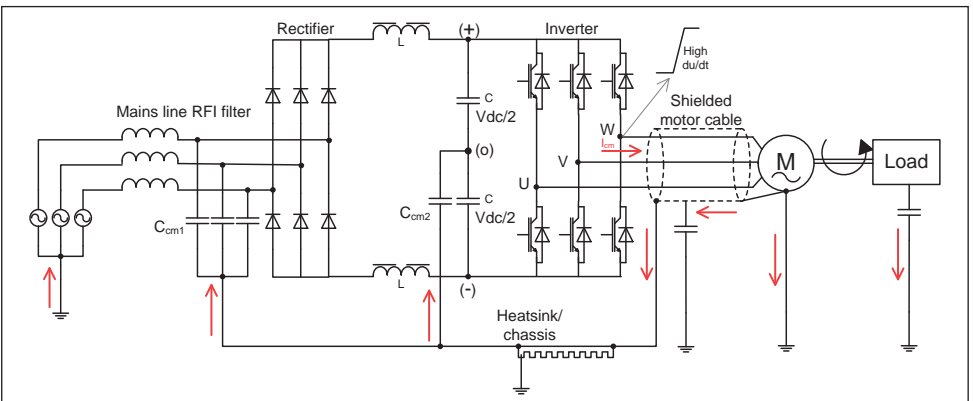

Fig. 5.4 Propagation of interference in a Frequency Converter

The noise source is the voltage source inverter that produces a pulse-shaped output voltage with very short rise- and fall times (also expressed as high du/dt). This voltage is applied across parasitic capacitances to ground in the motor cable and motor results in a common-mode current:

$$I_{cm} = C_{cm} \times \frac{du}{dt}$$

where C_{cm} is the parasitic capacitance to ground.

The common-mode current needs to close the loop and return to its source, the DC-link. Controlling the return path of the common-mode current is a key element of keeping electromagnetic interference under control. Inside the FC there are common-mode capacitors – that means capacitors between the FC circuit and ground/earth. The common-mode capacitors can be found in the RFI circuit (C_{cm1}) or as decoupling capacitors in the DC-link (C_{cm2}). If a shielded motor cable is used and the motor end of the cable is connected to the motor chassis and the FC end is connected to the FC chassis then, ideally, the common mode current will return to the DC link via the common-mode capacitors. The common-mode current returning through the mains supply is unwanted because it can cause interference in other equipment connected to the mains. Therefore this current must be minimised, for example by using RFI filters. When unshielded motor cables are used, then only a part of the common-mode current returns through the FC's chassis and common-mode capacitors thus causing more interference on the mains grid.

Immunity

Immunity, as well as noise emission need be considered in a FC application. The control signals connected to a FC can be quite susceptible to noise. In general, analogue signals are more susceptible than digital signals. Therefore it is better to use digital bus communication instead of analogue reference signals. If analogue signals cannot be avoided, a 4 – 20 mA current reference signal is preferred to a 0 – 10 V voltage reference signal because it is less susceptible to noise.

5.3 Grounding and Shielding

Grounding

Grounding means to connect electrical equipment to a common reference ground or earth. There are two reasons for doing this:

- **Electrical safety:** Safety grounding ensures that in the case of the degradation of electrical isolation no live voltage is present on conductive parts that can be touched by humans – thus avoiding the risk of electric shock.
- **Reduce interference:** Signal grounding reduces voltage differences that might cause noise emission or susceptibility problems.

It is very important to note that electrical safety always has the highest priority – higher than EMC.

Various types of grounding are common.

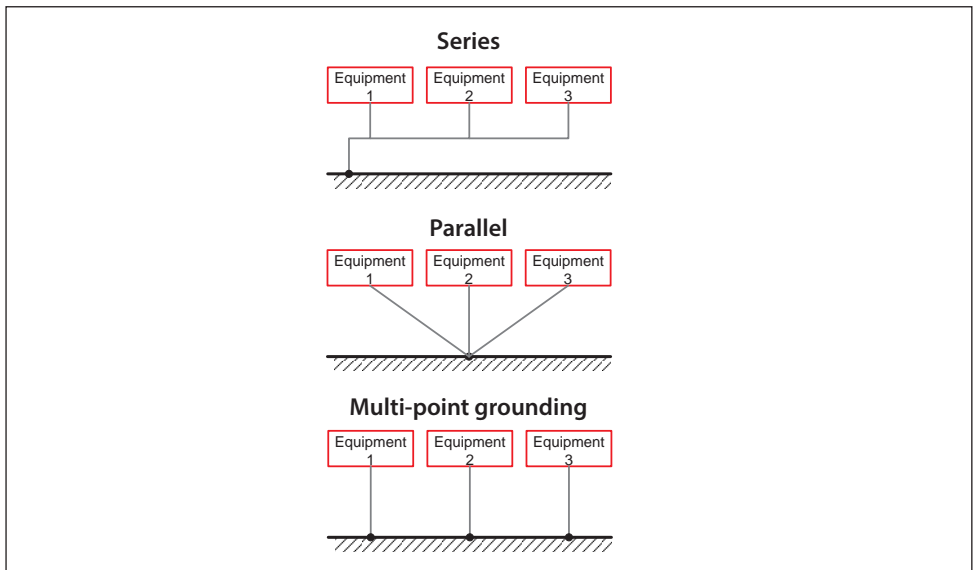

Fig. 5.5 Single point grounding in series or parallel and multi-point ground is possible

The different types of grounding have advantages and disadvantages, but what matters at the end of the day is that the impedance of the grounding connection is as low as possible in order to provide potential equalisation of the connected equipment.

Shielding

Shielding is used both for immunity (protecting against external interference) and emission (preventing interference to be radiated). In FC applications, shielded cables are used both for power (motor cable and brake resistor cable) and for signals (analogue reference signals, bus communication).

The shielding performance of a cable is indicated by its transfer impedance Z_T . The transfer impedance relates a current on the surface of the shield to the voltage drop generated by this current on the opposite surface of the shield:

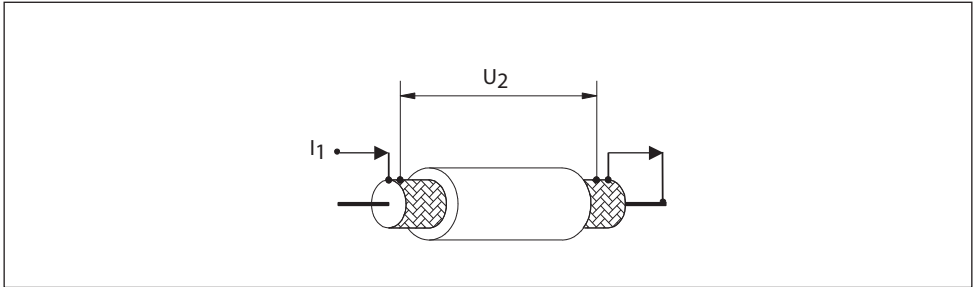

Fig. 5.6 Illustration of transfer impedance

$$Z_T = \frac{U_2}{I_1 \cdot L}$$

where L is the cable length

The lower the transfer impedance value the better the shielding performance. The table below shows typical values of transfer impedance for different kinds of motor cable. The most common type of motor cable is the single layer braided copper wire as it offers a good shielding performance at a reasonable price.

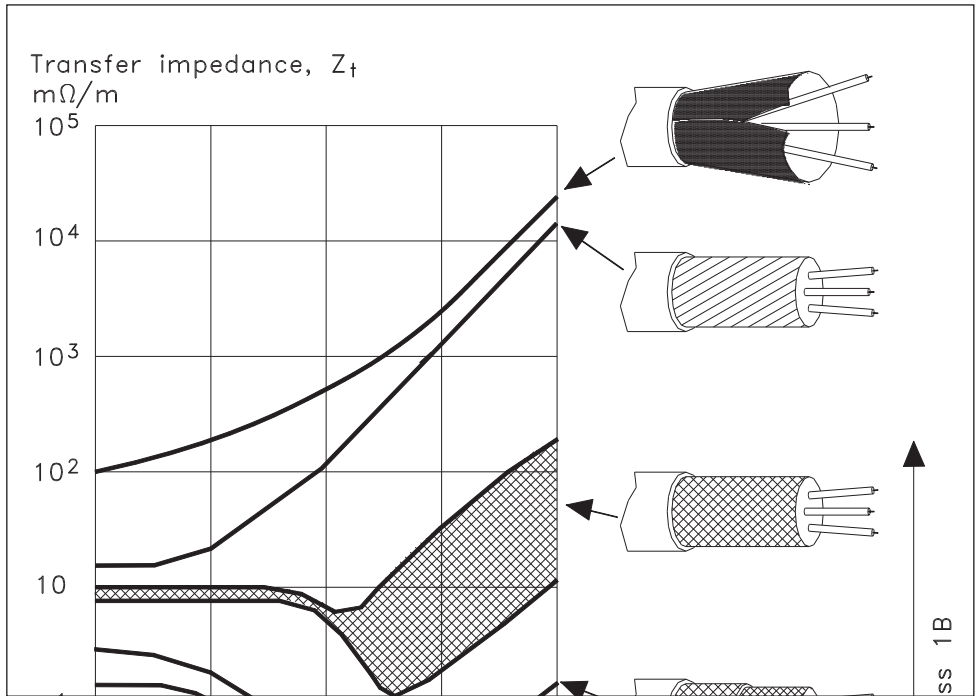

Fig. 5.7 Shielding performance of different cable types

Transfer impedance can be drastically increased by incorrect shield termination. The shield of a cable needs to be connected to the chassis of the equipment through a 360 degree connection. Using “pigtailed” to connect the shield increases transfer impedance and ruins the shielding effect of the cable.

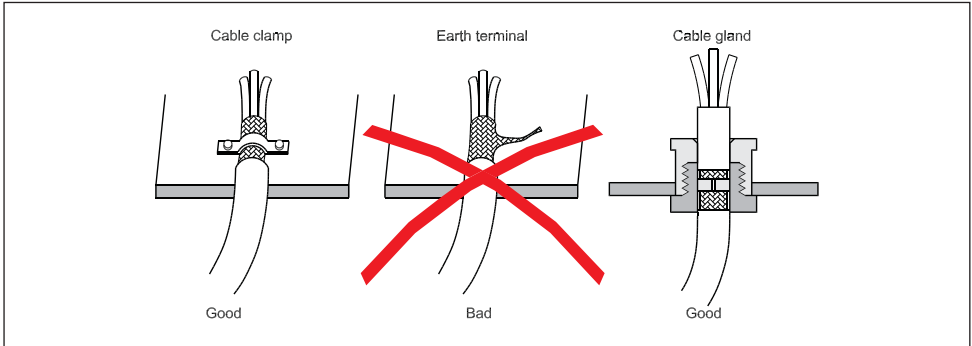
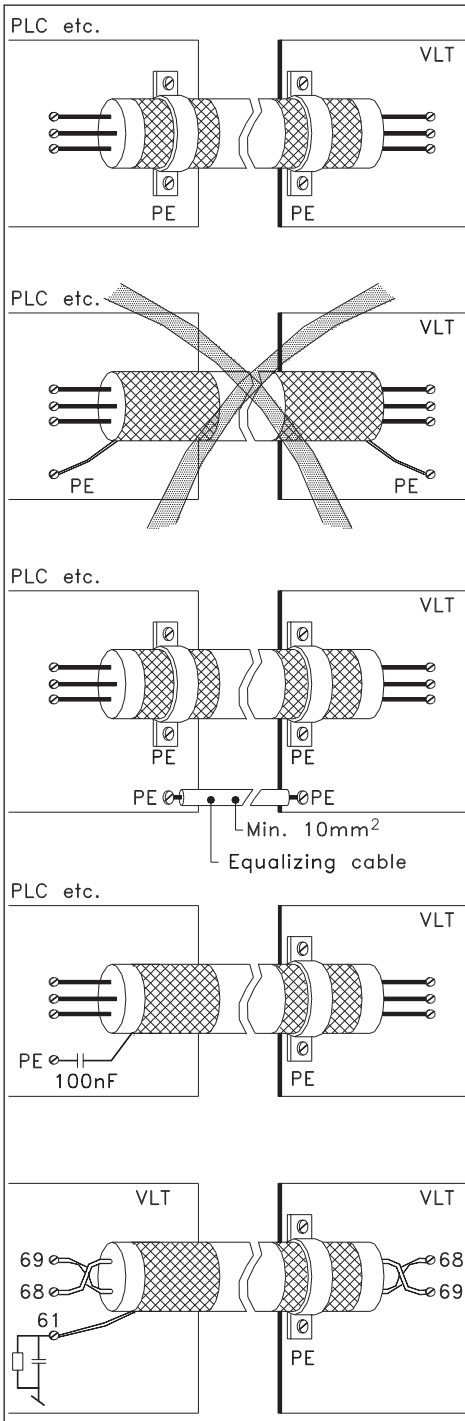

Fig. 5.8 Installation of cable shield

The question about terminating both ends or only one end of a shielded cable often occurs. It is important to realise that the effect of a shielded cable is reduced when only one end is terminated. It is very important to terminate correctly both ends of the motor cable, otherwise interference problems may occur.

The reason why in some situations only one end is terminated is to do with ground loops in signal cables. This means that there is a voltage potential difference between the chassis of the two pieces of equipment that are connected (for example frequency converter and PLC) and if the shield connects the two chassis a ground current will occur (with the frequency of 50 Hz/60 Hz). This current then couples into the useful signal disturbing it – in audio applications this is commonly known as “hum”. The best solution is to use an equalising connection in parallel with the shielded cable. If this is not possible then one end of the shielded cable can be terminated via a 100 nF capacitor. This breaks the ground loop at low frequency (50 Hz) while maintaining the shield connection in the high frequency range. In some equipment this capacitor is already built in. For example in the case of Danfoss VLT® frequency converters the shield connection for signal cables is provided at terminal 61.



Control cables and serial communication cables should normally be grounded at both ends.

Never terminate shield through pigtail.

Earth potential between PLC and drive: Disconnect cables and measure voltage with voltmeter to check. Use equalizing cable or make sure units are bolted together.

50/60 Hz ground loop: Use current clamp meter to check. => Ground one end through 100 nF capacitor with short leads.

Potential equalizing currents in serial communication cable shield between two drives: => Connect one end of the shield to the special shield connection terminal with RC decoupling. Remember "correct" pigtail installation!

Fig. 5.9 Grounding of cable shield

5.4 Installations with Frequency Converters

It is important to follow good engineering practice when installing frequency converters for ensuring electromagnetic compatibility. When designing an installation, an EMC plan can be made following these steps:

- List components, equipment and areas
- Divide into potential noise sources and potentially sensitive equipment
- Classify the cables connecting the equipment (potentially noisy or potentially sensitive)
- Set requirements and select the equipment
- Separate potential noise sources from potentially sensitive equipment
- Control interfaces between noise sources and sensitive equipment
- Route cables according to the classification

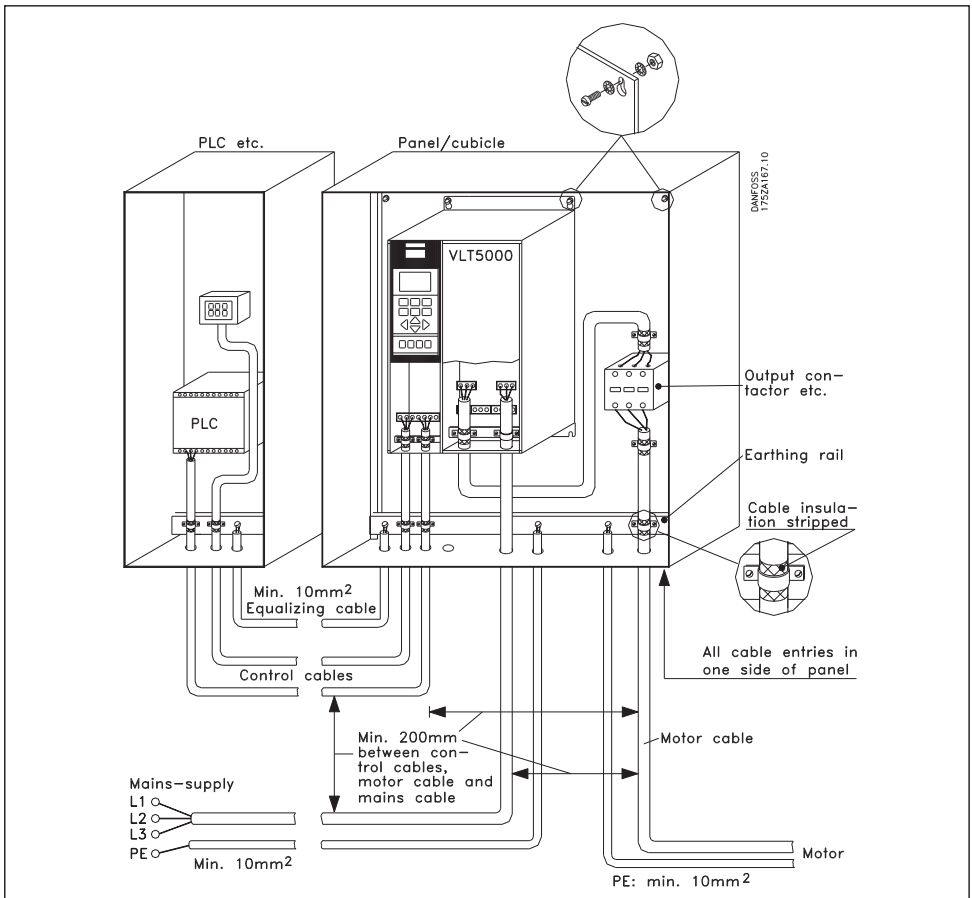

Fig. 5.10 Typical measures in practice in a simple frequency converter installation

5.5 Legislation and Standards

Legislation vs. standards

Legislation is issued by the legislative branch of national or local government and is mandatory to comply with – it is law. It is a political document, free of specific technical details – these details can be found in standards. Standards are written by experts in relevant standardisation bodies (such as the International Electrotechnical Commission IEC or the European Committee for Electrotechnical Standardisation CENELEC) and reflect the technical state of the art. Their role is to establish a technical common ground for cooperation between market players.

European EMC Directive

The latest EMC Directive is 2014/30/EU and comes into force on the 20th of April 2016 replacing the previous directive 2004/108/EC. This directive is a legal requirement in the European Union. In essence the requirements are simple:

- Products must not emit unwanted electromagnetic interference (limits emission)
- Products must be immune to a reasonable amount of interference (sets immunity requirements)

The directive itself is a political document and gives no specific technical requirements. A producer has the possibility of using harmonised standards to demonstrate compliance with the directive. Compliance with the EMC Directive (and also with other relevant directive such as the Low Voltage Directive – LVD) is stated in the product's Declaration of Conformity and the "CE" mark is affixed to the product.

The scope of the EMC Directive consists of following two categories:

- Apparatus: a finished appliance made commercially available as a single-function unit and intended for the end user. Apparatus complying with the requirements of the Directive are marked with the CE mark
- Fixed installations: a combination of apparatus or other devices which is permanently installed at a predefined location. Fixed installations are built following "good engineering practices" and respecting the information on the intended use of its components. Fixed installations are not CE marked

EMC Standards

There are different categories of standards, as follows:

- Basic standards deal with general aspects such as test set-up, measurement technique and emission lines. For adjustable speed drives the emission limits specified in EN55011 are commonly used

- Generic standards deal with specific environments and have been mainly developed to fill in the lack of specific product standards. For residential, commercial and light industry environments the generic immunity standard is EN61000-6-1 and the generic emission standard is EN61000-6-3. For industrial environments the generic immunity standard is EN61000-6-2 and the generic emission standard is EN61000-6-4
- Product standards apply for a specific product family. For frequency converters the standard is EN/IEC61800-3

The product standard for frequency converters sets both immunity and emission limits depending on the environment where the FC is used: residential environment (more strict emission limits, not so high immunity levels) or industrial environment (less strict emission limits, higher immunity levels).

EN/IEC 61800-3 Category	EN55011 Class	Generic Standard
C1	Class B	Residential area EN61000-6-3
C2	Class A, Group 1	Residential area
C3	Class A, Group 2	Industrial area EN61000-6-4
C3 (I > 100A)	Class A, Group 2, I > 100A	Industrial area
C4	No limits. Make an EMC plan	Industrial area

Table 5.1 Overview of different EMC standards

6 Protection against Electric Shock and Energy Hazards

6.1 General

Electrical products are often operated with voltages and currents that are potentially hazardous to people, animals and systems. These hazards can result from physical contact, overloading, short-circuiting, destruction of components or the influence of heat or moisture.

The resulting potential hazards must be avoided, or at least reduced to an acceptable minimum, by means of precautionary planning and design combined with fault analysis and estimation of the residual risk.

Considerations to ensure safety of Frequency Converters during installation, normal operating conditions and maintenance needs to be addressed during the design and construction of the FC. Also consideration shall be given to minimise hazards resulting from reasonably foreseeable misuse of the FC which might occur during its lifetime.

The protection against electrical shock is basically obtained by two levels of protection.

- Basic protection which protects the user against electrical shock under normal operating conditions. The basic protection is normally obtained by physical enclosure or barriers, or clearance /creepage distances
- Fault protection which protects the user against electrical shock under a single fault condition. The fault protection in FC's is normally obtained by use of plastic enclosures or appropriate protective earth connection

Additionally, a protective galvanic isolation is provided between the accessible control components/circuits and power components of FC's. This is to ensure that no dangerous voltage (e.g. mains voltage, DC-voltage and motor voltage) can appear on the control lines. This would make contact with the control lines potentially lethal, as well as creating a risk of damage to the equipment.

The international/European standard IEC/EN61800-5-1 describes in detail the requirement for protection against electrical shock as well as protection against other hazards applicable to FC's.

The enclosure rating of the FC provides protection against injury or damage from contact. An enclosure rating better than IP 21 prevents personal injury due to contact. Compliance with national accident prevention regulations (such as BGV-A3, which is

mandatory for electrical equipment in Germany) is also necessary to ensure protection against contact hazards.

Temperature and fire hazards

FC's can pose a fire hazard as a result of overheating. For this reason, they should be provided with a built-in temperature sensor that stops the operation of the FC if the cooling arrangement fails.

Under certain conditions, a motor connected to a FC can restart unexpectedly. For example, this can occur if timers are enabled in the FC or temperature limits are monitored.

Emergency stops

Depending on system-specific regulations, it may be necessary to fit an emergency stop switch near the motor. This switch can be incorporated in the mains supply line or the motor cable without damaging either the FC or the motor.

6.2 Mains Supply Systems

There are different ways of connecting the mains supply to earth, each with advantages and disadvantages. There are three main earth arrangements, as defined in IEC 60364:

TN, TT and IT. The letters stand for

T – Terra (lat.) = connection to earth

N – Neutral = direct connection to the neutral

I – Isolated = no connection/floating

TN-S system

Distribution inside a building must fulfill the requirements of a TN-S system, so no combined PEN conductors may be used.

The TN-S system has the best EMC performance because the neutral and PE conductors are separated. Thus a current through the N does not produce any effects on the voltage potential of the PE. This is the preferred system for frequency converter applications.

The disadvantage of the TN-S system, which is in general the disadvantage of both TN and TT systems, is that in the case of an earth fault on the line, the protection fuses will stop the operation.

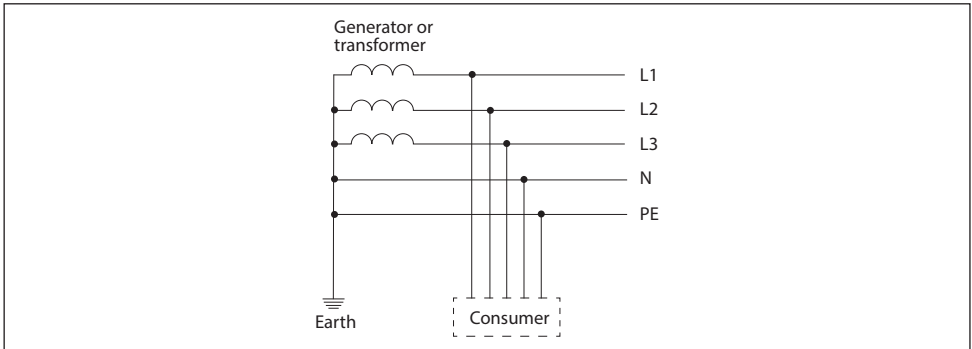

Fig. 6.1 TN-S system: Separate neutral and PE conductors.

TN-C system

In the TN-C system the PE and N conductors are combined in a PEN conductor. The disadvantage is that a current through the N conductor is also a current through the PE, thus a voltage potential between earth and the chassis of the connected equipment occurs. In a 50 Hz/60 Hz world, with linear loads, this system does not pose any special issues. But when electronic loads are present, including FC's, the high frequency currents that occur can cause malfunctions. Although this system is compatible with FC's it should be avoided because of the associated risks. From an EMC perspective the TN-C system is not optimal.

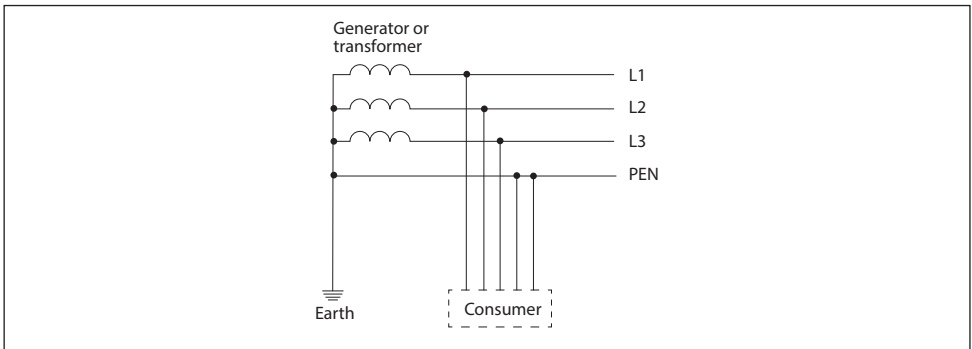

Fig. 6.2 TN-C system: In the entire system, the neutral conductor and the PE conductor are combined in the PEN conductor.

TN-C-S system

The TN-C-S system is a hybrid between TN-C and TN-S. From the transformer to the building distribution point the PE and N are common (PEN) – just like in the TN-C system. In the building the PE and N are separated, like in the TN-S. As the impedance of the PEN conductor between the transformer and the building distribution point is typically low, it reduces the negative effects that occur on the TN-C mains.

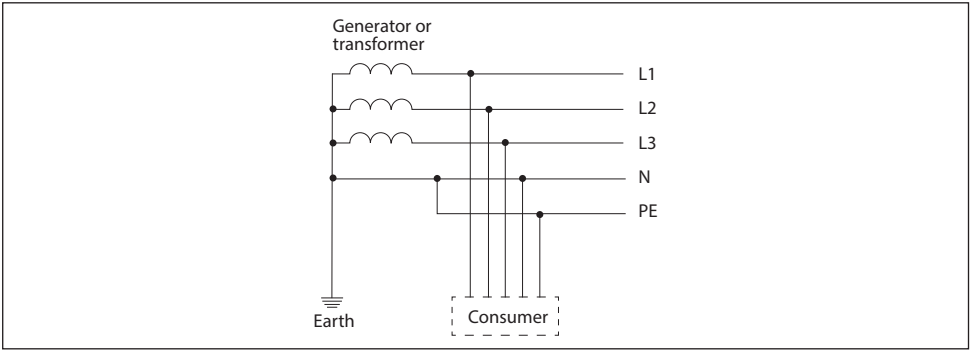

Fig. 6.3 TN-C system: In the entire system, the neutral conductor and the PE conductor are combined in the PEN conductor

TT system

In the TT system the PE at the consumer is provided by a local earth electrode. The main advantage of the TT system is that the high frequency currents in the PE circuit of the consumer are separated from the low frequency currents in the N conductor. From an EMC perspective this is the ideal system.

However, because of the unknown impedance of the earth connection between the earth of the transformer and the earth of the consumer, it cannot be guaranteed that a line to PE short circuit at the consumer will blow the fuses quickly enough and protect against electrical chock. This disadvantage can be mitigated by using residual current devices (RCD).

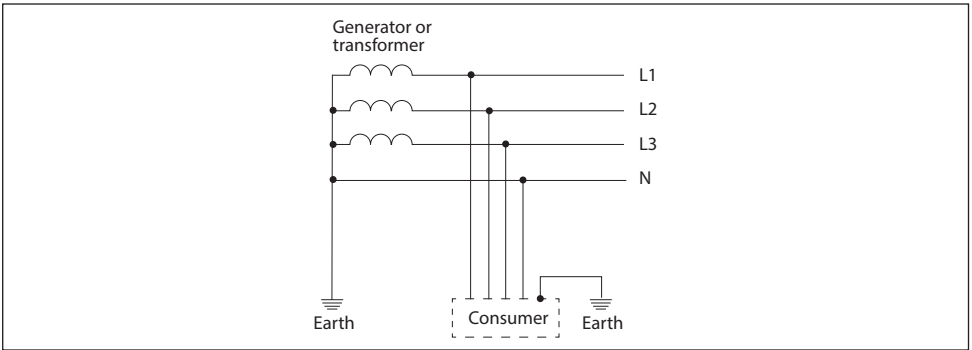

Fig. 6.4 TT system: Earthed neutral conductor and individual equipment/installation earthing

IT system

In the IT mains the transformer is unearthed and the three phases are floating. The rationale for such a system is the ability of continuing operation after a line to earth fault occurs. Isolation monitoring devices are used for observing the integrity of the isolation between phases and earth. If the isolation is degraded, corrective maintenance can be carried out.

The disadvantage of this system is its poor EMC performance. Indeed, any earth noise current will cause the entire system to float with the noise, possibly causing malfunction of electronic equipment. When FC's are used on IT mains special considerations have to be taken, for example by disconnecting all capacitors to earth (such as the common-mode capacitors in the RFI filter). Consequently, conducted emissions will be unfiltered and a lot of high frequency noise can be found on IT mains.

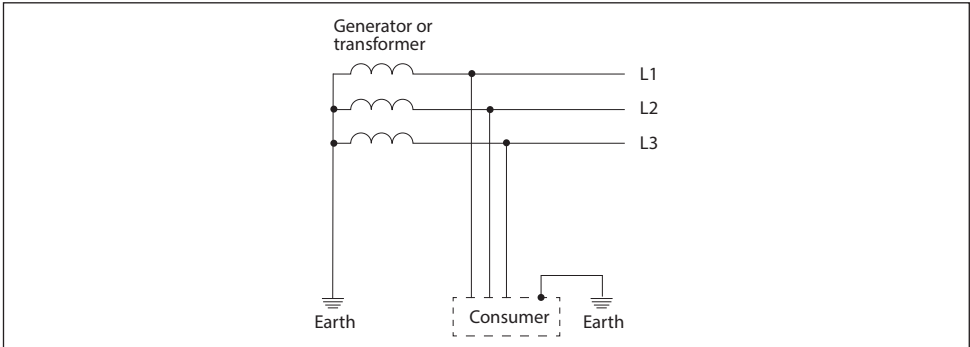

Fig. 6.5 IT system: Isolated mains; the neutral conductor may be earthed via an impedance or unearthed

6.3 Additional Protection

The degradation of the isolation between live parts and chassis leads to earth leakage currents and can compromise both personal safety (risk of electric shock) and equipment safety (the risk of over-heating components that can eventually lead to a fire). The use of additional protective devices depends on local, industry-specific or statutory regulations.

There are two types of protection relays for additional protection. One type uses a fault voltage relay, while the other uses a residual current relay. Additional protection with a fault voltage relay (FU relay) can be provided in most installations. Protection is achieved by connecting the relay coil between the earthing terminal of the FC and the system earthing point. A fault voltage trips the relay and disconnects the FC from the mains.

In practice, FU relays are advantageous in situations where earthing is not allowed. Whether or not they are allowed to be used depends on the regulations of the electricity supply company. This form of protection is very rarely used. Earth Leakage protection with a residual current operated circuit breaker (RCCB) is allowable under certain conditions. Residual current operated circuit breakers contain

a sum-current transformer. All of the supply conductors for the FC pass through this transformer. The sum-current transformer senses the sum of the currents through these conductors.

The sum is zero if there is no leakage current in the installation. If there is a leakage current, the sum is not zero and a current is induced in the secondary winding of the transformer. This current switches off the relay and disconnects the FC from the mains. Conventional RCCBs use inductive sensing and are therefore only suitable for sensing AC currents.

FC's with B6 input bridge rectifiers can cause a pure DC current to flow in the supply cable in the event of a fault. It is recommended to check whether DC current can be present at the input to the FC. If it can, a Type B RCD (sensitive to both AC and DC) must be used to obtain reliable protection. This type of RCD has additional integrated circuitry that allows it to detect both AC and DC residual current.

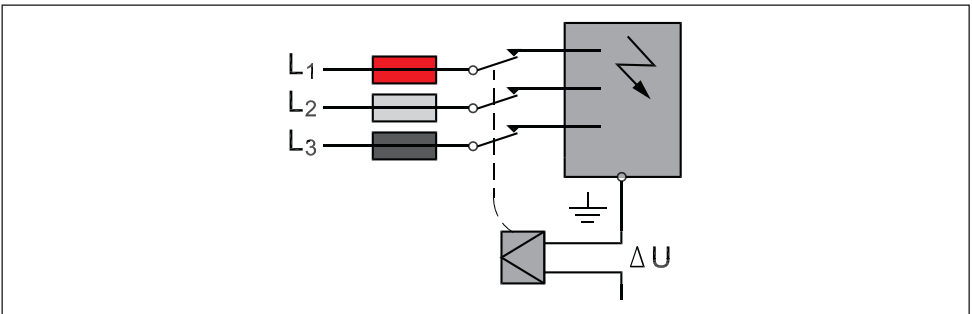

Fig. 6.6 Fault voltage relay

These devices are commonly known as residual current operated circuit breakers (RCCBs). The higher-level term is "residual current operated device" (RCD) in accordance with EN 61008-1.

Filters and components for RFI suppression (common-mode capacitors) always cause a certain amount of leakage current. The leakage current produced by a single RFI suppression filter is usually just a few milliamperes. However, if several filters or large filters are used, the resulting leakage current may reach the trip level of the RCD.

The interference suppression components used with FC's generate leakage currents. For this reason, the earth connection must be made as follows:

- If the leakage current is greater than 3.5 mA, the cross-section of the PE conductor must be at least 10 mm²

- Otherwise, the equipment must be earthed using two separate PE conductors. This is often called "reinforced earthing"



	Alternating fault currents
	Pulsating DCs (pos. and neg. half-wave)
	Sloping half-wave currents Angle of slope $\frac{90^\circ \text{ el.}}{135^\circ \text{ el.}}$
	Half-wave current with overlay of smooth fault DCs of 6 mA
	Smooth fault DCs

Fig. 6.7 Waveforms and designations of residual currents

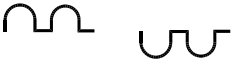
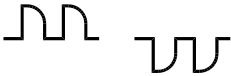
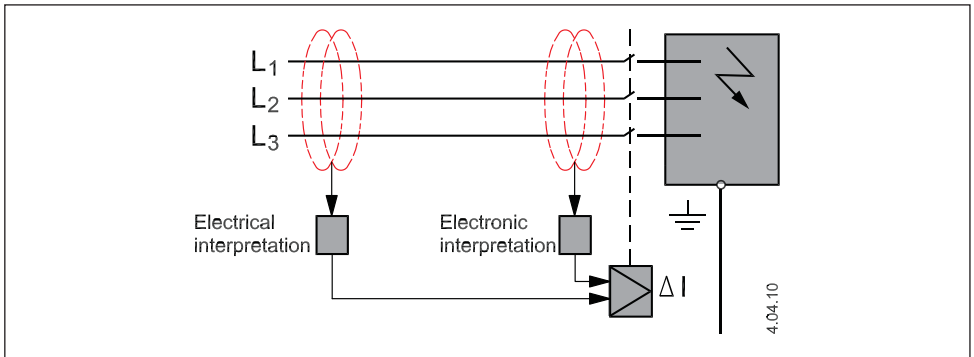

Fig. 6.8 Universal RCCB

6.4 Fuses and Circuit Breakers

For protecting FC's and the installation against electrical and fire hazard they need to be protected against short-circuit and over-current by means of an over-current protective device (e.g. fuse or circuit breaker). The protection needs to comply with relevant local, national and international regulations.

A fuse interrupts excessive current, to prevent further damage to the protected equipment. It is characterised by a rated current (the current that a fuse can

continuously conduct) and speed (which means how long it takes to blow the fuse at a given overcurrent). The higher the current the shorter time it takes to blow the fuse. This is expressed by time current characteristics, as shown in Fig. 6.9 Time-current characteristics of fuses:

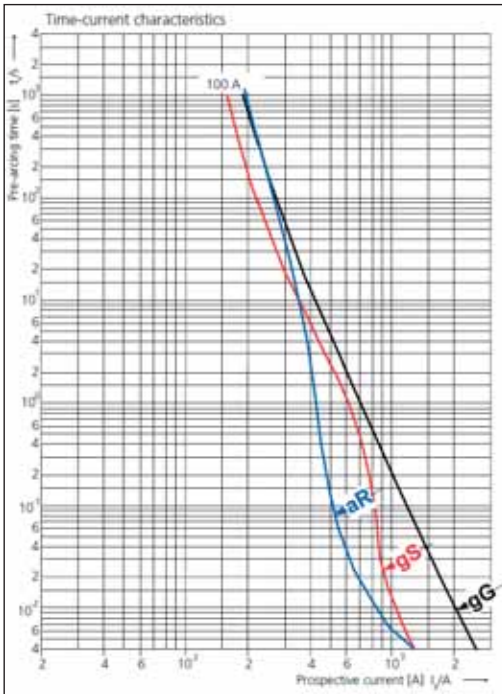

Fig. 6.9 Time-current characteristics of fuses

There are different standardised time-current characteristics depending on the intended application. For protecting FC's typically aR fuses for semiconductor protection are used to limit the damage in case of a short-circuit or internal component breakdown. In some situations gG type general purpose fuses can be used. For the specific fuse selection it is important to consult the documentation of the FC and strictly follow those recommendations, since the recommended fuses are tested together with the FC.

Circuit breakers

Unlike fuses which are sacrificial devices that need to be exchanged after being blown, circuit breakers are electromechanical devices that can be simply reset after being activated. Because the speed of circuit breakers can be slower than fuses, their use needs to be carefully considered. The slow speed can lead to extensive damage in the protected device, subsequent overheating and even a fire risk. Not all FC's are suitably-designed to be protected with circuit breakers. Special considerations are taken in the design phase of FC's to limit the damage in the case of a component breakdown inside the FC. Such measures are, for example, special internal mechanical features in the enclosure, use of shields, use of deflecting foils, etc. to limit the consequences of internal failures.

It is essential to consult and strictly follow the recommendations found in the documentation of the specific FC regarding the use of circuit breakers, including the type and manufacturer of circuit breaker to be used, since the recommended devices have been tested with that FC.

7 Mains Interference

7.1 What are Harmonics?

7.1.1 Linear Loads

On a sinusoidal AC supply a purely resistive load (for example an incandescent light bulb) will draw a sinusoidal current, in phase with the supply voltage.

The power dissipated by the load is: $P = U \times I$

For reactive loads (such as an induction motor) the current will no longer be in phase with the voltage, but will lag the voltage creating a lagging true power factor with a value less than 1. In the case of capacitive loads the current is in advance of the voltage, creating a leading true power factor with a value less than 1.

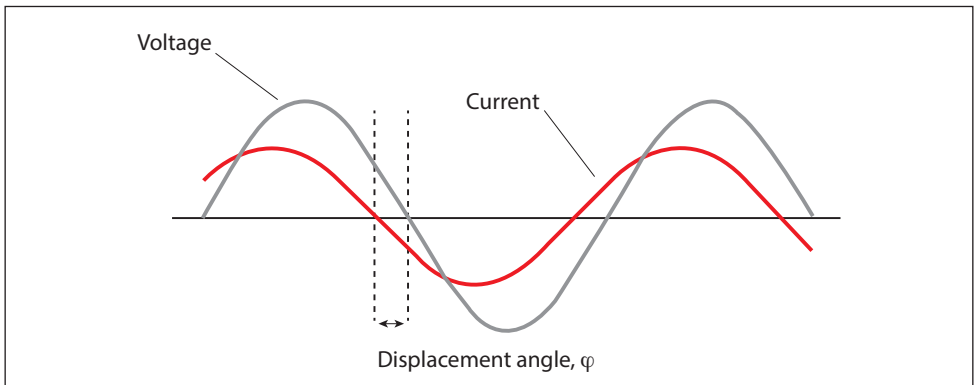

Fig. 7.1 Linear Load

In this case, the AC power has three components: real power (P), reactive power (Q) and apparent power (S).

The apparent power is: $S = U \times I$

In the case of a perfectly sinusoidal waveform P , Q and S can be expressed as vectors that form a triangle:

$$S^2 = P^2 + Q^2$$

Units: S in [kVA], P in [kW] and Q in [kVAR].

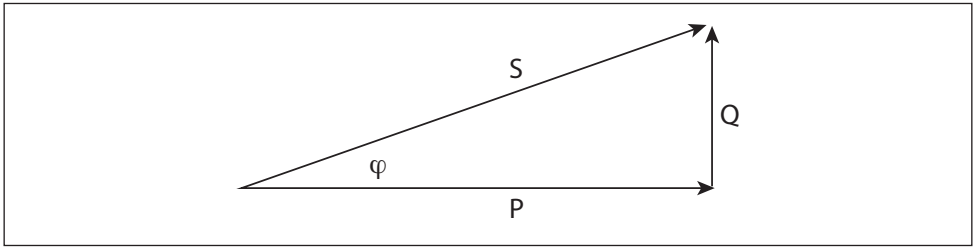

Fig. 7.2 Components of AC Power: Real Power (P), Reactive Power (Q) and Apparent Power (S)

The displacement angle between current and voltage is ϕ .

The displacement power factor is the ratio between the active power (P) and apparent power (S):

$$DPF = \frac{P}{S} = \cos(\phi)$$

7.1.2 Non-linear Loads

Non-linear loads (such as diode rectifiers) draw a non-sinusoidal current. Fig. 7.3 shows the current drawn by a 6-pulse rectifier on a three phase supply.

A non-sinusoidal waveform can be decomposed in a sum of sinusoidal waveforms with periods equal to integer multiples of the fundamental waveform.

$$f(t) = \sum a_h \times \sin(h \omega t)$$

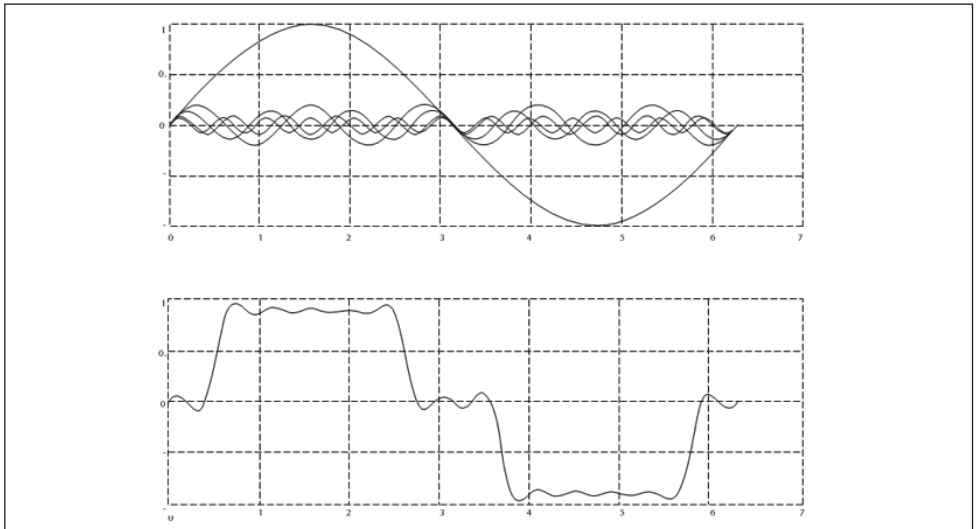

Fig. 7.3 Non-linear Load: Current drawn by a 6-pulse rectifier on a 3-phase supply

The integer multiples of the fundamental frequency ω_1 are called harmonics. The RMS value of a non-sinusoidal waveform (current or voltage) is expressed as:

$$I_{\text{RMS}} = \sqrt{\sum_{h_1}^{h_{\text{max}}} I(h)^2}$$

The amount of harmonics in a waveform gives the distortion factor, or total harmonic distortion (THD), represented by the ratio of RMS of the harmonic content to the RMS value of the fundamental quantity, expressed as a percentage of the fundamental:

$$\text{THD} = \sqrt{\sum_{h_2}^{h_{\text{max}}} \left(\frac{I_h}{I_1}\right)^2} \times 100 \%$$

Using the THD, the relationship between the RMS current I_{RMS} and the fundamental current I_1 can be expressed as:

$$I_{\text{RMS}} = I_1 \times \sqrt{1 + \text{THD}^2}$$

The same applies for voltage.

The true power factor PF (λ) is:

$$\text{PF} = \frac{P}{S}$$

In a linear system the true power factor is equal to the displacement power factor:

$$\text{PF} = \text{DPF} = \cos(\varphi)$$

In non-linear systems the relationship between true power factor and displacement power factor is:

$$\text{PF} = \frac{\text{DPF}}{\sqrt{1 + \text{THD}^2}}$$

The power factor is decreased by reactive power and harmonic loads. Low power factor results in a high RMS current that produces higher losses in the supply cables and transformers.

In the power quality context, the total demand distortion (TDD) term is often encountered. The TDD does not characterise the load, but it is a system parameter.

TDD expresses the current harmonic distortion in percentage of the maximum demand current I_L .

$$THD = \sqrt{h_{\max} \sum_{h_2} \left(\frac{I_h}{I_L}\right)^2} \times 100 \%$$

Another term often encountered in literature is the partial weighted harmonic distortion (PWHHD). PWHHD represents a weighted harmonic distortion that contains only the harmonics between the 14th and the 40th, as shown in the following definition.

$$PWHHD = \sum_{h=14}^{40} h \left(\frac{I_h}{I_1}\right)^2 \times 100 \%$$

7.1.3 The Effect of Harmonics in a Power Distribution System

The picture below shows an example of a small distribution system. A transformer is connected on the primary side to a point of common coupling PCC1, on the medium voltage supply. The transformer has impedance Z_{xfr} and feeds a number of loads. The point of common coupling where all loads are connected together is PCC2. Each load is connected through cables that have respective impedance Z_1, Z_2, Z_3 .

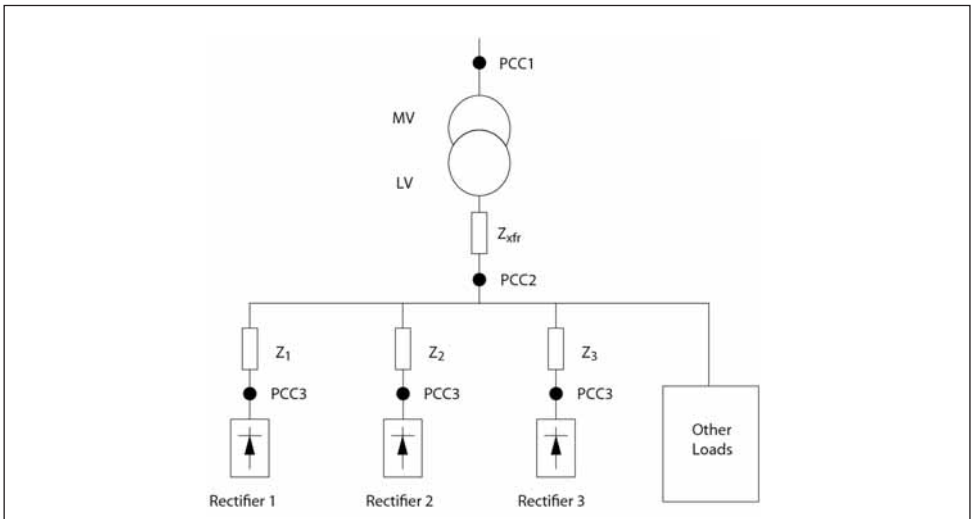

Fig. 7.4 Example of Distribution System

Harmonic currents drawn by non-linear loads cause distortion of the voltage, due to the voltage drop on the impedances of the distribution system. Higher impedances result in higher levels of voltage distortion.

Current distortion relates to apparatus performance and it relates to the individual load. Voltage distortion relates to system performance. It is not possible to determine the voltage distortion in the PCC knowing only the harmonic performance of the load. In order to predict the distortion in the PCC the configuration of the distribution system and relevant impedances must be known.

A commonly used term for describing the impedance of a grid is the short circuit ratio R_{sce} , defined as the ratio between the short circuit apparent power of the supply at the PCC (S_{sc}) and the rated apparent power of the load (S_{equ}).

$$R_{sce} = \frac{S_{sc}}{S_{equ}}$$

$$\text{where } S_{sc} = \frac{U^2}{Z_{supply}} \quad \text{and} \quad S_{equ} = U \times I_{equ}$$

The negative effect of harmonics is twofold

- Harmonic currents contribute to system losses (in cabling, transformer)
- Harmonic voltage distortion causes disturbance to other loads and increase losses in other loads

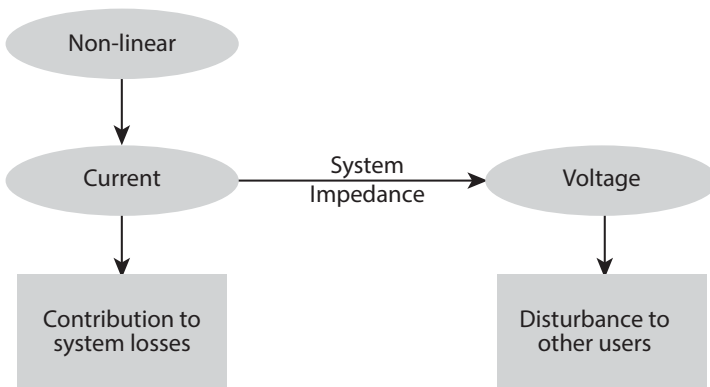

Fig. 7.5 Negative Effects of Harmonics: System Losses and Disturbance

7.2 Harmonic Limitation Standards and Requirements

The requirements for harmonic limitation can arise from:

- Application-specific requirements
- Requirements for compliance with standards

The application-specific requirements are related to a specific installation where there are technical reasons for limiting the harmonics.

Example: 250 kVA transformer with two 110 kW motors connected.

Motor A is connected directly to mains supply, and Motor B is supplied through Frequency Converter B. There is a need to retrofit FC A, so that Motor A is supplied through its own FC, but the transformer will, in this case, be undersized. Solution: In order to retrofit without changing the transformer, mitigate the harmonic distortion from FC's A and B using harmonic filters.

There are various harmonic mitigation standards, regulations and recommendations. Different standards apply in different geographical areas and industries. The most common are the following:

- IEC/EN 61000-3-2, Limits for harmonic current emissions ($\leq 16A$ per phase)
- IEC/EN 61000-3-12, Limits for harmonic currents ($>16A$ and $\leq 75A$)
- IEC/EN 61000-3-4, Limitation of emission of harmonic currents ($> 16A$)
- IEC/EN 61000-2-2 and IEC/EN 61000-2-4 Compatibility levels for low frequency conducted disturbances
- IEEE519, IEEE recommended practices and requirements for harmonic control in electrical power systems
- G5/4, Engineering recommendation, planning levels for harmonic voltage distortion and the connection of nonlinear equipment to transmission systems and distribution networks in the United Kingdom

7.3 Harmonic Reduction Methods in Frequency Converters

The line current of unmitigated diode rectifiers has a total harmonic distortion (THD) of at least 80%. This high distortion value is unacceptable in most applications with FC's. Therefore it is necessary to have some harmonic mitigation. The level of harmonic mitigation depends, as explained earlier, on the specific installation and the harmonic standards the installation needs to comply with.

An overview of the various harmonic mitigation methods is shown in Table 7.1 – Harmonic Mitigation Methods.

Mitigation method	Circuit diagram	Typical current waveform
No mitigation THD > 80%		
DC inductors THD < 40%		
AC inductors THD < 40%		
Passive harmonic filter THD < 10%		
Multi-pulse rectifier (12/18) THD < 10%		
Active front end THD < 5%		
Active filter THD < 5%		Waveform similar to AFE

Table 7.1 Harmonic Mitigation Methods

Harmonic mitigation can be achieved by using either passive or active circuits.

7.3.1 Passive Harmonic Mitigation

DC inductors

DC inductors are placed in the DC link between the rectifier and the bulk DC capacitor. It is possible to use a single inductor in either the + or the – side or use two inductors. This solution reduces THDi to values between 35 and 45%.

AC inductors

AC inductors are placed on the line side of the rectifier. Their harmonic performance is similar to DC inductors and reduce THDi to typical values of between 35 and 45%, depending on the size of the inductor.

DC vs. AC inductors

Since DC and AC inductors have similar harmonic performance levels the question about the differences between the two solutions often arises. First of all, even if the THD value is similar, the effect of the two solutions on the components of the harmonic spectrum is different. DC inductors attenuate more the low frequency components (5th, 7th, 11th harmonic) while the AC inductors have a better performance for higher harmonic orders.

Across inductors an AC voltage drop occurs. In the case of AC inductors, a voltage drop will occur, typically around 4%. In the case of DC inductors, the DC current does not cause a voltage drop. The only voltage drop across DC inductors results from the current ripple of the rectifier. Consequently, using DC inductors will result in a higher DC link voltage, thus the ability to provide more torque at the motor shaft. This is the major advantage of DC inductors. The main advantage of AC inductors is that they protect the rectifier against transients from the mains.

Passive harmonic filters

Passive harmonic filters are connected in series with the mains supply. They can be realised with various circuit topologies that typically consist of combinations of inductors (L) and capacitors (C), sometimes also damping resistors R. The filter circuit can be a low-pass circuit, tuned to specific harmonics (5th, 7th, etc.) or slightly de-tuned, to avoid the risk of resonances. The performance of passive filters depends on the specific frequency converter's DC link configuration (with/without DC chokes, value of capacitance) and a performance level can be assured for a specific configuration. Danfoss Advanced Harmonic Filters (AHF) are designed specifically for Danfoss VLT® frequency converters and can reduce THD to 10 % (AHF10 series) or even 5% (AHF 5 series). These filters use a proprietary topology with a two-stage de-tuned LC harmonic- absorbing circuit.

Passive filters have the disadvantage of being quite bulky (comparable in size with the FC). They have a capacitive power factor that needs to be considered during system level design for avoiding resonances.

Multi-pulse rectifiers

Multi-pulse rectifiers are fed from phase-shift transformers. The most common solutions are with 12 pulses (2 x 3 phases) or 18 pulses (3 x 3 phases). Through phase-shifting, low order harmonics are in 180° opposition, cancelling each other. For example, in the case of 12 pulse rectification the phases of the secondary have a 30° phase offset (the offset between the D and Y windings). In this configuration the 5th and 7th harmonics are cancelled and the largest harmonics will be the 11th and 13th. Multi-pulse harmonic mitigation requires large transformers – larger than the FC. Another disadvantage is that the performance is reduced in non-ideal conditions such as voltage imbalance.

7.3.2 Active Harmonic Mitigation

Active Front End (AFE)

The diode rectifier can be replaced with an inverter with active switches (usually IGBT transistors), similar to the inverter at the motor side. The grid-side inverter is pulse-width modulated and the input current is nearly sinusoidal. The harmonics of the mains frequency are not present. On the other hand the switching frequency components are injected to the mains grid. In order to reduce the switching noise a passive filter is used, usually in a low-pass L-C-L topology (two inductors and capacitors between the inductors).

The main advantage of the AFE is that it allows four-quadrant operation: that means that the energy flow is bi-directional and in the case of regenerative braking the energy can be injected back to the grid. This is advantageous in applications with frequent braking or long-time braking such as cranes or centrifuges.

The disadvantage of the AFE solution is a relatively low efficiency and a high complexity. When the application does not require bi-directional energy flow the energy efficiency of the AFE is inferior to an active filter solution.

Active filters

Active filters (AF) consist of an inverter that generates harmonic currents in anti-phase with the harmonic distortions on the grid thus achieving a 180° cancellation effect. The operation principle is illustrated in the illustration below, where the AF cancels the harmonic currents from a diode rectifier.

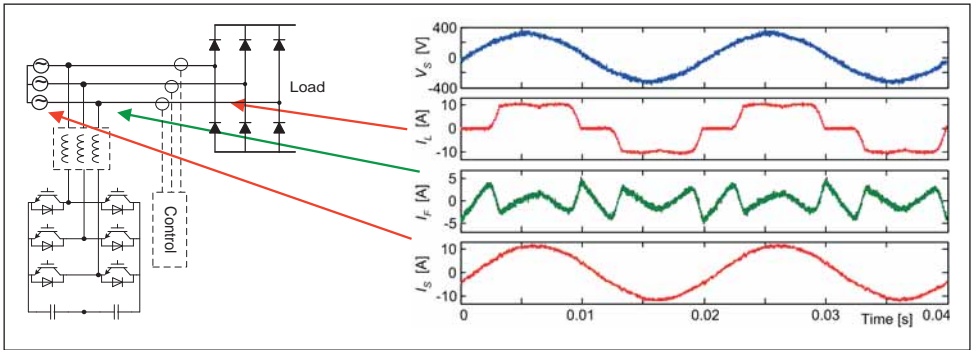

Fig. 7.6 Operation Principle of an Active Filter

As in the case of AFE, an LCL filter is needed to eliminate the noise at the switching frequency.

Active filters are connected in parallel with the non-linear (harmonic generating) load. This allows for several harmonic mitigation possibilities:

- Individual compensation of non-linear loads: an active filter compensates harmonics from a single load. Danfoss offers an optimised filter + FC package called “Low Harmonic Drive (LHD)”
- Group compensation: harmonics from a group of several loads (for example FC’s) are compensated by a single filter
- Central compensation: harmonics are compensated directly at the point of common-coupling of the main transformer

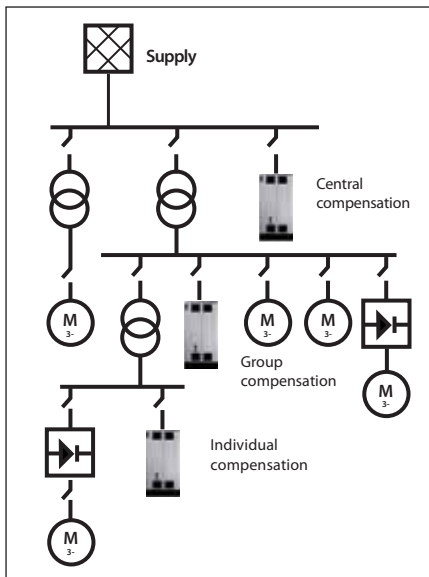

Fig. 7.7 Harmonic compensation can take place in different areas of the network

7.4 Harmonic Analysis Tools

Harmonic analysis tools can be used to calculate harmonics in a system and design the optimal harmonic mitigation solution to meet specific requirements. The advantage of software tools is that different solutions can be compared, allowing the selection of the best solution.

There are a variety of commercially available software tools ranging from simple calculation tools for a non-linear load to complex software packages that allow the design of an entire power system.

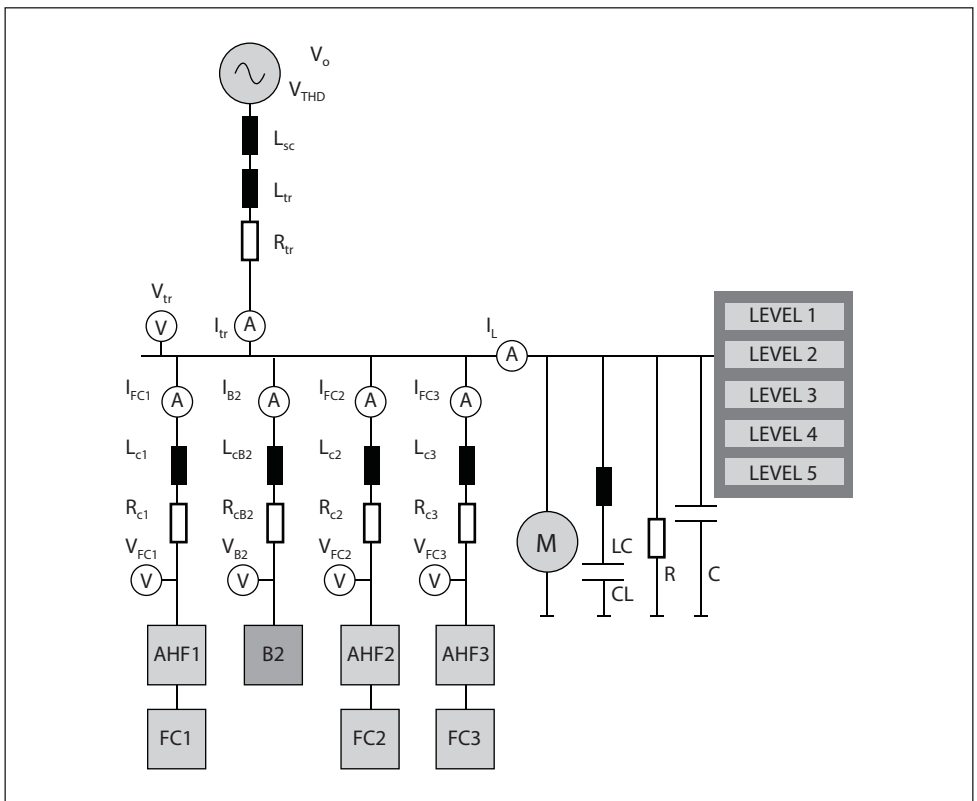

Fig. 7.8 Calculation model with current and voltage measurement points

Danfoss offers two software tools:

- the offline tool VLT® Motion Control Tool MCT 31 and
- the on-line tool HCS (Harmonic Calculation Software)

7.4.1 VLT® Motion Control Tool MCT 31

MCT 31 is an off-line software package used to calculate harmonics based on polynomial interpolation between pre-defined simulation results. The advantage of this method is speed and the disadvantage is that it is less precise compared to a simulation.

MCT 31 enables simulations with all Danfoss products, including mitigation solutions such as AHF passive filters and AAF active filters. Generic, non-Danfoss frequency converters can be simulated as well. MCT 31 can generate harmonic reports.

7.4.2 Harmonic Calculation Software (HCS)

The HCS tool can be accessed on-line at Danfoss website. It is available in two levels: basic for simple calculations and expert for more complex system level calculations.

Behind the web interface of the HCS tool there is a powerful circuit simulator that performs a simulation of the specific system designed by the user. Therefore it is more precise than the interpolation-based MCT 31.

HCS has a vast library containing Danfoss FC's, AHF passive filters, AAF active filters. It also features the time-domain and frequency domain graphical visualisation of the voltages and currents in a system and comparing the harmonics to different limit lines. HCS can also generate reports in HTML or PDF format.

8 Interfaces

8.1 Human Machine Interface (HMI)

The Human Machine Interface (HMI) is an important and vital part of Frequency Converters today. The HMI interface can vary from a basic LED status indicator to a sophisticated field bus system with detailed FC information. The HMI will set up an interface between a human and an application that allow the user to control, monitor and diagnose the application.

Modern FC's today often have these HMI interfaces:

LED

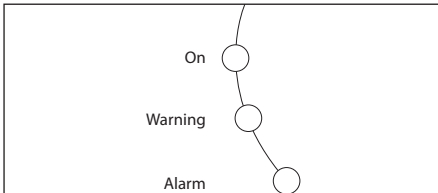

Fig. 8.1 LED indication

An LED to indicate that power is applied to the FC

An LED to indicate that a warning is present

An LED to indicate an alarm on the FC

Numerical and/or alphanumerical panels



Fig 8.2 Numerical and/or alphanumerical panels

These devices provide an easy possibility to control the FC, monitor its actual status and for easy commissioning of the application.

Input and output terminals



Fig. 8.3 Input and output terminals

Dedicated input and output control terminals are available in order to build an interface between a PLC control and the FC.

Input control signals like start/stop, coast or reverse control will ensure that the user has functions to control the FC according to the application. For controlling the speed, and feedback signals from the application analogue input signals like 0-10 V or 0/4-20 mA can be applied.

Feedback signals from the FC to the PLC are digital output or relay output which can be configured to indicate status like “motor running” or “alarm”. Also analogue output signals from the FC can be configured to monitor, for instance, the actual load conditions.

Software tools

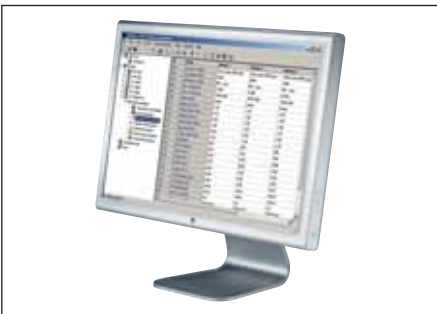

Fig. 8.4 Software tools

Integration of the FC into PC software gives the user full system configuration and control. With PC Software it is possible to monitor the entire system more effectively for faster diagnosis, and better preventive maintenance.

A modern PC Software tool can be used as follows:

- For planning a new communication network offline. PC Software tools contain a complete database with supported FC products
- For commissioning FC's online
- For easy replacement of a FC, in the event of failure
- For easy expansion of the network with more FC's
- For back-up of parameter settings of FC's in a communication network
- Software supports fieldbus protocol. This will eliminate the need for an extra communication network

Fieldbus

Use a standardised fieldbus interface between the PLC and FC for commissioning, control and monitoring of the application.

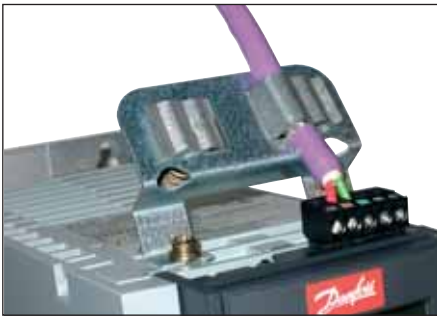

Fig. 8.5 Fieldbus connection

8.2 Operating Principles of Serial Interfaces

In serial data transmission, the bits (with a state of 0 or 1) are transmitted individually, sequentially. A logical 0 or a logical 1 is defined by specified voltage levels. Various methods and standards have been developed to ensure fast, error-free data transfer. The method used depends on the specification of the interface. If we look at the lowest level of data transfer, a distinction can be made between how the bits are transmitted electrically (current or voltage signal) and the system used (line coding). If the bits are transmitted via a voltage signal, the focus is less on the voltage level than the reference potential of the level.

Principle	Standard (application)	Devices connected per trunk circuit	Max. distance in mm	Number of lines	Signal level
	RS 232 (point to point)	1 sender 1 receiver	15	Duplex min. 3+ various status signals	$\pm 5\text{ V min.}$ $\pm 15\text{ V max.}$
	RS422 (point to point)	1 sender 10 receivers	1200	Duplex: 4	$\pm 2\text{ V min.}$
	RS485 (Bus)	32 senders 32 receivers	1200	Semi duplex: 2	$\pm 1.5\text{ V min.}$

Table 5.1 3 fieldbus principles and typical specifications

RS-232/ EIA-232 interface

The RS-232 interface, launched as early as 1962, was for a long time the serial interface par excellence. When a serial interface was mentioned in relation to PCs, it referred to RS-232. RS-232 was conceived for communication between two devices (point-to-point connection) at low transmission speeds.

RS-422/ EIA-422 interface

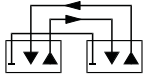
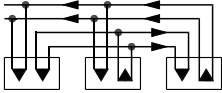
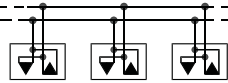
RS-422 allows both point-to-point and multi-drop networks to be built. In multi-drop networks, it is possible to connect multiple receivers to one transmitter. The data is transmitted differentially via twisted data cables. One pair of lines is needed for each transmission direction for full duplex operation.

RS-485/ EIA-485 interface

RS-485 is regarded as a higher-level version of the RS-422 standard and accordingly has similar electrical properties.

In contrast to RS-422, however, RS-485 is designed as a multi-point (bus-capable) interface over which up to 32 devices can communicate. There are now also transceiver modules (combined transmitter and receiver module) with which networks of up to 256 devices can be implemented. The actual maximum possible network size depends on both the transmission rate (line length) and the structure of the network (network topology).

USB interface

The Universal Serial Bus (USB) standard was developed in 1995 by Intel in conjunction

with companies in the IT industry. The USB 2.0 extension of the standard in 2000 increased the transmission speed from 12 Mbps to 480 Mbps. Additionally, in 2008 USB 3.0 was introduced, allowing transmission speeds of up to 5 Gbitps. The data is transmitted differentially via a twisted pair. The maximum cable length between two devices must not exceed 5 m.

Despite its name, USB is not a physical data bus, but rather a point-to-point interface. The term “bus” in the name USB refers only to the structure with which a network can be built. The USB specification provides for a central host (master) to which up to 127 different devices can be connected. Only one device can be connected directly to a port. An additional hub is required to connect more than one device to a port.

Ethernet interface

The Ethernet standard was developed back in the early 1970's. Since then Ethernet has become more and more present in all kinds of products. In the 90's Ethernet found its way to the automation field via protocols like: MAP, Modbus TCP and EtherNet/IP. Ethernet typically runs on 100 Mbps, over STP cables (Shielded Twisted Pair), but is also available in wireless, fibre optic and other media. The benefit of using Ethernet is not only the fast speed and standardised cables & connectors, but the ability to access data inside automation equipment from the office network. This allows status to be read from all over the plant, even from another continent.

Despite the fact that all Ethernet protocols runs on Ethernet, it does not mean that it is possible to run different Ethernet technologies in the same network. Technologies that change the arbitration or have strict demands towards timing make a mix of technologies impossible. The mainstream Ethernet technologies today are PROFINET, EtherNet/IP, Modbus TCP, POWERLINK and EtherCAT. Today, these technologies have more than 90% of the market share in new installations.

8.3 Standard Serial Interfaces in Frequency Converters

Today, most FC's today are fitted as standard with a serial system interface that can be used for connection to a network.

Various standardised protocols are generally supported, in addition to unpublished, manufacturer-specific (proprietary) protocols. Physically, the interfaces are very often based on the specification of the RS-485 interface.

Since FC's usually only have a serial RS-485 interface available, interface converters are required for implementation. Manufacturer-specific solutions in which a particular FC' is required are widespread. If the interface specification is published, simple industry-standard converters (such as USB to RS-485) can be used.

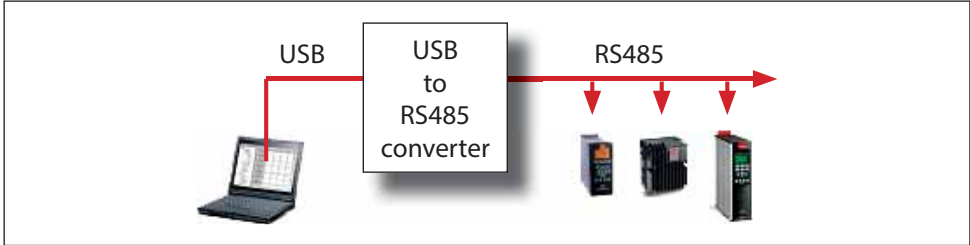

Fig. 8.6 USB to RS 485 communication

FC's are increasingly being fitted with USB interfaces for simple data exchange with a PC. Since many PCs have USB interfaces, the use of interface converters is becoming obsolete.

8.4 Fieldbus Interfaces in Frequency Converters

The use of modern FC's without a serial communication interface is almost inconceivable today. In the simplest case, the interface consists of two data lines through which the FC can be controlled, monitored, configured and documented. Almost all bus systems enable multiple devices to be on the same network.

Compared with conventional FC control via digital and analogue inputs and outputs, there is less cabling involved in serial bus systems, which reduces installation cost. On the other hand, costs are incurred for the interfaces and additional components are required to control the bus system. Depending on the bus system used, only a few networked devices are necessary to generate considerable cost benefits compared with conventional control.

Traditional wiring. No fieldbus.

In this type of network, communication between the drive and PLC requires one cable for each parameter that needs to be controlled. The advantage of such a system is that the individual components themselves are relatively cheap, and the system itself is not among the most complex.

This, however, comes at a price, as such systems are relatively expensive both to install and extend, as each additional parameter or drive requires new cabling, PLC programming and often more I/O hardware. For owners this means higher capital costs and restricted flexibility. At the same time the risk of error is high, as the risk of a faulty connection to the PLC increases with the number of cables.



Fig. 8.7 Traditional wiring. No fieldbus

Fieldbus wiring

A typical fieldbus system only uses twisted pair cables to connect the drive to the PLC. Despite the higher cost of components, fieldbus systems offer several advantages over older, hardwired systems: fewer cables, faster commissioning and a reduced risk of faults.

Additional drives are connected in a serial Ethernet-based network that can be extended easily. New parameters only need to be coded into the PLC, which is both faster, safer and at significantly lower cost than a hardwired system.

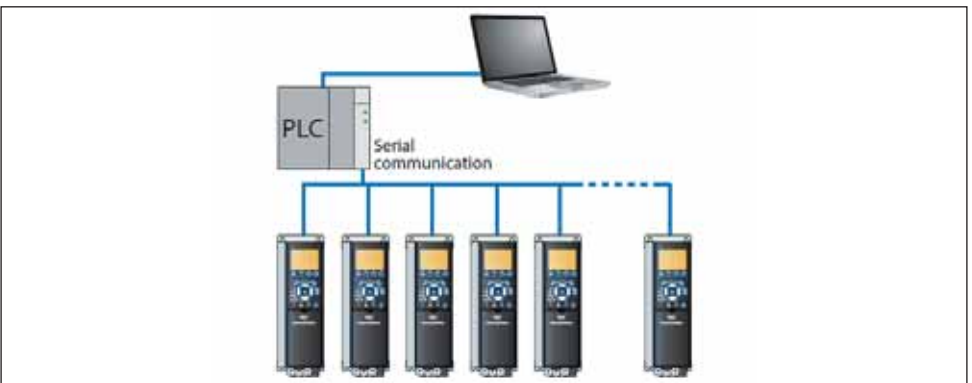

Fig. 8.8 Fieldbus wiring

Fieldbus over Ethernet

The Ethernet interface enables the possibility to access drive parameters and information from locations outside the production facility. This method bypasses the traditional control hierarchy, as communication with the fieldbus-fitted drives and other equipment does not necessarily need to pass through the PLC.

External access is routed through a firewall, enabling communication with the fieldbus option's built-in webserver.

Not only does this provide a high degree of flexibility during commissioning, it also provides advantages such as external monitoring and application support.

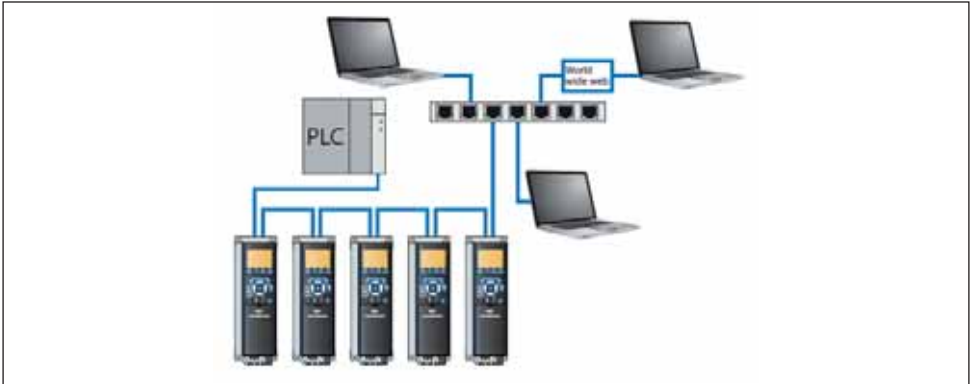

Fig. 8.9 Fieldbus over Ethernet

8.5 Fieldbuses Standardisation

The development of fieldbuses began in the 1980s so that the benefits of serial communication could also be used in the field. The driving force for the development included not only the potential to save cost and time during planning and installation but also the ease of expansion and increased interference immunity when transmitting analogue signals.

In the years that followed, it became clear that the success of a system depends not only on industrial capability in a demanding environment but also on "openness". In open-bus systems, the installation and control are the same, irrespective of the manufacturer of the bus components. The end user can therefore replace a (defective) device from one manufacturer with a device from another manufacturer without having to make major changes to the system.

The principal difference between the interfaces and bus systems available on the market are the physical design and the protocols used. Which system is used depends on the requirements of the application in question.

Fast processes such as packaging machines may need bus cycle times of just a few milliseconds, whilst response times of seconds may suffice for climate control systems.

For the purposes of better classification, communication systems can be considered in terms of data volume, transfer time and transmission frequency. The diagram below shows the basic division into three different levels.

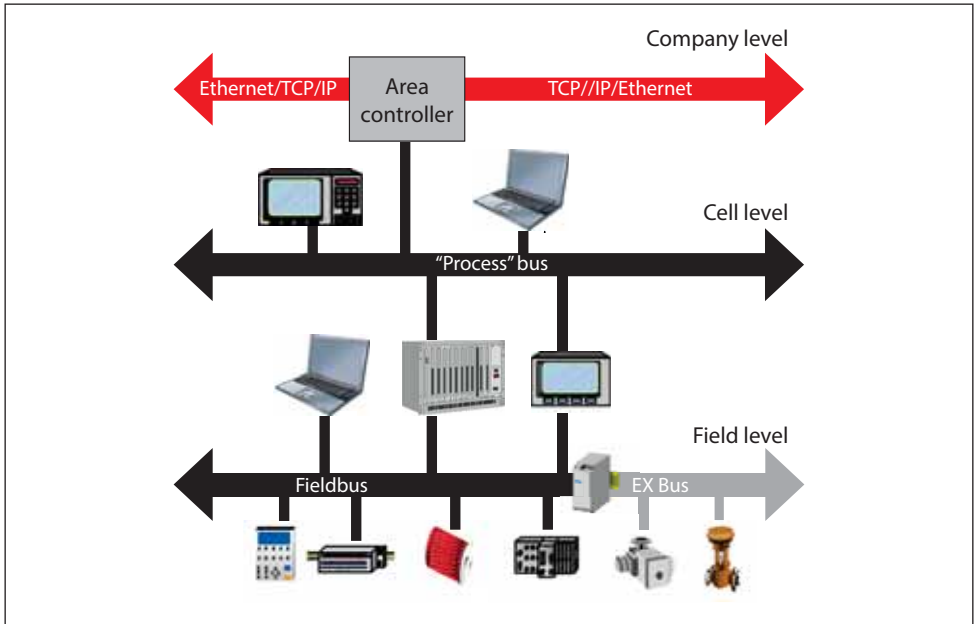

Fig. 8.10 Production pyramid

- At the company level, large data volumes in the megabyte range are exchanged. The transfer times can extend to hours.
- At the cell level, the data volume decreases to the kilobyte range. At the same time, the transfer time shortens (seconds) and frequency of data exchange (minutes/hours) rises.
- At the field level, very small data volumes of a few bytes or even bits are exchanged. The transfer time and transmission frequency are a matter of milliseconds.

The world's most important field buses have been standardised since 1999 in IEC 61158.



Fig. 8.11 Typical field buses

Different Bus systems have more or less significance depending on the region and application. If you look at drive technology, Profibus and its Ethernet based successor (PROFINET) can be considered to have a larger market share in Europe. In contrast, DeviceNet and EtherNet/IP are frequently used in North and South America as well as in Asia. This defines the precondition for the high market acceptance of the respective Ethernet based successors PROFINET in Europe and EtherNet/IP in North America.

9 Sizing and Selection of Frequency Converters

9.1 Get the Drive Rating Right

Selecting the right Frequency Converter is a key aspect of designing a variable speed drive system. If the selected unit is too small, it will not be able to control the connected motor optimally at all necessary operating points. If, on the other hand it is too large, there is a risk that the motor will not always be controlled properly, and the design may not be cost-effective.

For the design of most FC's, knowledge of the following basic parameters is sufficient:

- Rating of FC from motor specifications
- Current distribution in the FC ($\cos \varphi$ of the motor)
- Overload capacity
- Control range and field weakening
- Derating of FC
- Regenerative energy
- Motor cable length
- Environment
- Central versus de-centralised installation

After clarification of the basic design parameters for an application, design and analysis of the mechanical components is carried out. The motor to be used must be determined before a suitable FC can be selected. In facility service systems, for example, final selection often takes place only shortly before the building is completed.

Only at this time are most of the components to be used defined, so that an optimised analysis of flow conditions can be carried out reliably.

The more dynamic and challenging the application, the greater the number of factors that must be taken into account in the design. Since FC manufacturers can save costs by restricting the technical features, for each particular case it is necessary to confirm that the features needed for the drive are actually available.

9.2 Rating of the Frequency Converter from Motor Specifications

A widely used method for selecting FC's is simply based on the rated power of the motor to be used. Although manufacturers specify the power ratings of their FC's, this data normally relates to standard four-pole motors. Since the rated currents of motors differ significantly at the same power depending on the construction of the motor (e.g. standard motor and geared motor) and its number of pole pairs, this method is only suitable for providing a rough estimate of the proper FC size. Fig. 9.1 – Nominal current for 1.50kW motors of different poles and manufacturer – shows examples of the rated currents of various 1.5 kW motors.

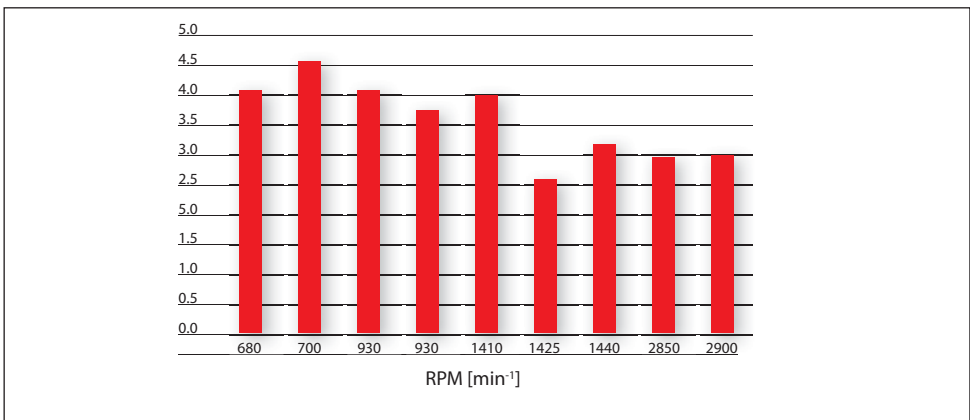

Fig. 9.1 Nominal current for 1.50kW motors of different poles and manufacturer

Furthermore, it should be noted that the current drawn by a motor depends on whether it is connected in star or delta configuration. For this reason FC's should be selected based on the rated current for the type of configuration selected (star or delta).

In addition to the motor current, the required motor voltage must be taken into account. Many FC's can operate over a wide mains supply voltage range (e.g. 3 x 380 – 500V) and thus provide a wide output voltage range. However, the apparent power that the unit can supply is constant over the whole voltage range. Thus the maximum output current is higher at a lower mains voltage and, correspondingly, lower at a higher voltage.



Fig 9.2 Identification data of a Danfoss frequency converter

The nameplate in Fig. 9.2 Identification data of a Danfoss frequency converter comes from a 0.75 kW FC. The specified current values apply to two different voltage ranges. The FC can deliver 2.4 A with a mains voltage of 380 – 440 V. If the unit is supplied with a mains voltage of 441 – 500 V, it can deliver 2.1 A. However, the apparent power available with both voltage ranges is always 1.70 kVA.

9.3 Overload Capacity

When selecting a FC, the load conditions of the application should always be taken into account first. A fundamental distinction is made between quadratic and constant load characteristics, which are the most common in practice.

When a FC controls a motor, torque limits can be set for that motor. Selecting a FC with an apparent power rating that matches the rated current or power of the motor ensures that the required load can be driven reliably. However, an additional reserve is necessary in order to enable smooth acceleration of the load and also cater for occasional peak loads.

Below are examples of a constant load torque characteristic. If a load is placed on a conveyor belt, the torque that must be applied to transport the load is constant over the entire speed range.

Application	Excess load
Lifting equipment	160%
Conveyor belt	160%
Stirrer / Mixer / centrifuge	160%
Rotary piston compressor / piston compressor	150%
Spiral pump (thick sludge)	150%
Sludge dehydration press	150%
Piston pump	150%
Rotary gate valve	150%
Rotary piston blower	110%
Surface aerator	110%
Metering pump	110%
Booster pumps (2-stage)	110%
Recirculation pump	110%
Side channel blower for pool aeration	110%

Table 9.1 Typical overloads in constant torque applications

With a constant load, an over-load reserve of approximately 50 to 60% for 60 seconds is typically used. If the maximum over-load limit is reached, the response depends on the FC used. Some types switch off their output and lose control of the load. Others are able to control the motor at the maximum over-load limit until they trip for thermal reasons.

A quadratic load characteristic usually occurs in applications where increasing speed leads to an increasing quadratic load torque. Fans and centrifugal pumps are amongst the types of equipment that display behaviour of this kind. Furthermore, most applications with a quadratic torque characteristic, such as centrifugal pumps or fans, do not require rapid acceleration phases. For this reason excess load reserves of 10 % are usually chosen for quadratic torques.

See next page with examples of a quadratic load torque characteristic.

Application	Excess load
Fan	110%
Well pump	110%
Booster pump / centrifugal pump	110%
Filter infeed pump	110%
Groundwater pump	110%
Hot water pump	110%
Non-clogging pump (solid materials)	110%
Centrifugal pump / fan	110%
Primary and secondary heating pump	110%
Primary and secondary cooling water pump	110%
Rainwater basin evacuation pump	110%
Recycling sludge pump	110%
Spiral pump (thin sludge)	110%
Submerged motor pump	110%
Excess sludge pump	110%

Table 9.2 Typical overloads in variable torque applications

Even with quadratic load and an over-load capacity of 10% modern FC’s can be set up to have a higher break-away torque at start to ensure the proper start of the application.

Remember to consider whether the application will always require a quadratic torque. For example, a mixer has a quadratic torque requirement when it is used to mix a very fluid medium, but if the medium becomes highly viscous during processing, the torque requirement changes to constant.

9.3.1 Energy Efficiency Concerns

In chapter 4 Saving Energy with Frequency Converters we have seen different considerations to be taken to save energy. It is important to remember, that the most energy efficient solution is where the machine, the motor and the FC are selected for the best system efficiency. For example fans speed will typically differ from nominal speed, and so the motor, but many motors have their highest efficiency at a speed between 75 and 100% of nominal speed.

Some brands of FC have a built-in software function, which secure the best motor shaft power related to the FC input power.

9.4 Control Range

The advantage of a FC lies in its ability to regulate smoothly the speed of the motor. However, a wide variety of limits are set for the available controlling range.

On the one hand the possible controlling range (speed range) depends on the control algorithms available of the unit. With the simple U/f control, control ranges that can vary within 1:15 can usually be achieved. If a control algorithm with a voltage vector control is used, a range of 1:100 is possible. If the actual motor speed is fed back to the FC by an encoder, adjustment ranges from 1:1,000 to 1:10,000 can be realised.

In addition to the limits of the control algorithms used, the field-weakening range around the rated frequency of the motor and also low speed running must be taken into account. At low speeds, the motor's self-cooling capacity is reduced. Therefore, in the event of continuous operation in this speed range, either a separately powered external fan must be used to cool the motor or the shaft load must be reduced. The speed below which the torque must be reduced can be found in the manufacturer's data sheets.

If the motor is operated in the field-weakening range, the reduction in the available torque with $1/f$ and the breakdown torque with $1/f^2$ must also be taken into account. The field-weakening range begins when the FC can no longer hold the U/f ratio constant. In Europe this point typically lies at 400 V/50 Hz and in North America at 460 V / 60 Hz.

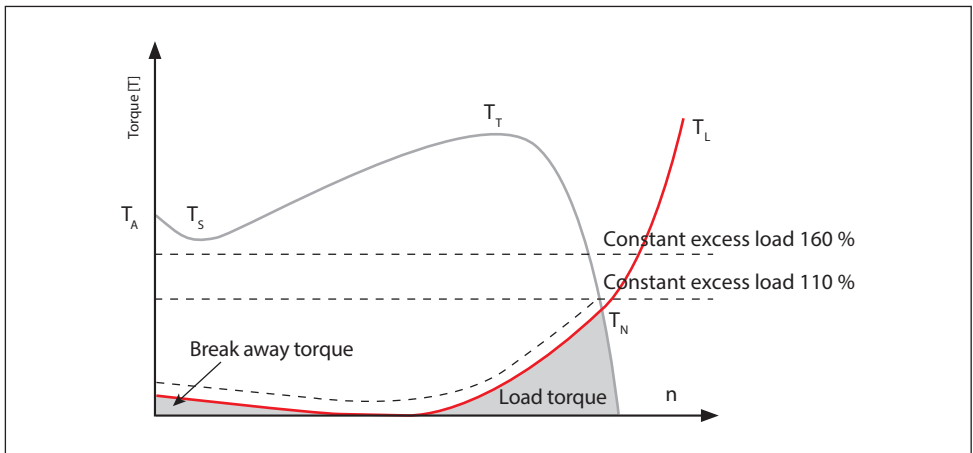

Fig. 9.3 Frequency converter with an optimised characteristic for quadratic loads and an over-load of 110%. In order to achieve higher breakaway torque, the drive is sometimes started with a constant torque before the quadratic characteristic is used

Sometimes motor manufacturers specify higher available torque at a lower duty cycle. A design optimised for intermittent operation can be economical, but it requires a more complex design as shown in Fig. 9.4 Obtaining a good match in speed selection.

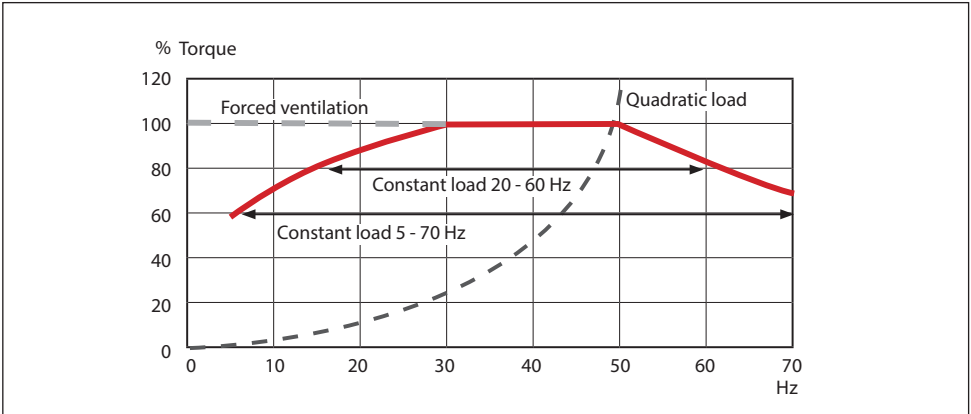

Fig. 9.4 Obtaining a good match in speed selection

9.5 Derating of FC

Maximum ambient temperatures are defined for FC's, as for all electronic units. If the maximum ambient temperature is exceeded, it could lead to failure of the FC, but it also reduces the life-time of the electronics. According to Arrhenius' law, the life-time of an electronic component is reduced by 50% for each 10°C that it is operated above its specified temperature. If FC's have to be operated continuously near the maximum rated operating temperature and the specified life-time of the FC still must be maintained, one option is to derate the power.

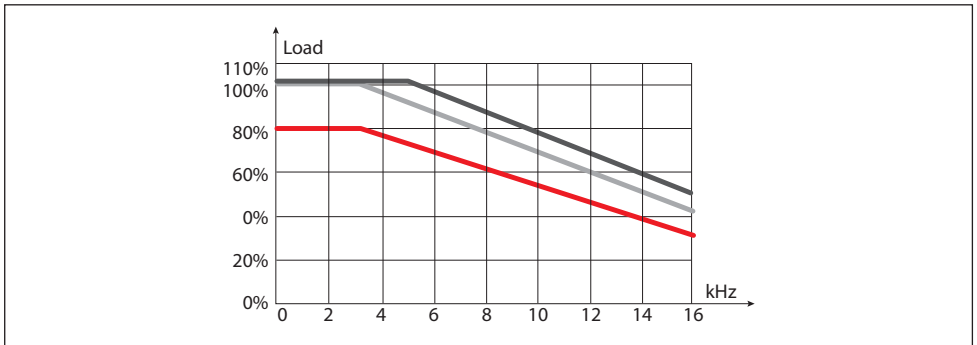

Fig. 9.5 Power reduction diagram for switching frequency and temperature

In the diagram 9.5 Power reduction diagram for switching frequency and temperature, the switching frequency of the inverter is plotted on the X axis. The output current (in %) of the unit is plotted on the Y axis.

Higher switching frequencies result in less irritating motor noise levels. However, the power dissipation in the inverter increases with the switching frequency, leading to additional heating of the unit. Reducing the switching frequency allows the switching losses to be reduced. If the switching frequency is too low, the motor tends to run less smoothly. The switching frequency is thus always a compromise between noise generation, smooth running, and losses.

If, for example a unit is operated at an ambient temperature of 45°C, it can continuously deliver 100% of its rated output current at a switching frequency of 4 kHz. If the ambient temperature increases to 55°C, a current of only around 75% is possible in continuous operation without a reduction of life-time. If the reduction of life-time is not acceptable, a larger FC with sufficient power reserve must be used.

Power derating curves must be observed not only at elevated temperatures, but also at reduced air pressures, such as when FC's are used at elevations above 1000metres.

9.6 Regenerative Energy

If a motor is driven by an FC that during deceleration the rotor will run faster than the rotating magnetic field causing the motor to act as a generator.

Depending on how much energy is fed back from the motor and how often, various measures must be taken. If the power exceeds the total power losses of the motor and the FC, the intermediate circuit voltage will increase until, at a defined voltage, the FC disables its output and consequently loses the control of the motor.

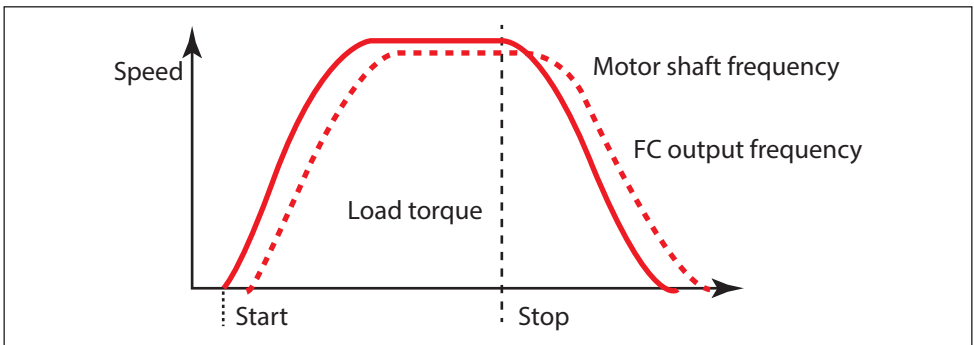

Fig. 9.6 Start/Stop illustrations for regenerative principle

A simple way to avoid such an overvoltage situation is to oversize the FC which would then be able absorb more regenerative energy and hence reduce the risk over-voltage. However, this is often a more expensive solution compared to dynamic braking methods, including the possibility of feeding back the energy to the supply grid. For details please refer to the corresponding subsections in chapter 3 Frequency Converters and Motors.

9.7 Motor Cables

The power components of FC's are designed for specific motor cable lengths. If the specified cable length is exceeded, malfunctions can occur and the FC could trip with an error/alarm message. The capacitance of the cable used is partly responsible for this behaviour. If the capacitance at the FC output exceeds a specified value, transients can occur on the cables that can lead to a malfunction of the FC.

Most manufacturers prescribe shielded cables for their FC's to prevent potential EMC problems. If the user decides on other suitable measures for compliance with EMC requirements then unshielded cables can be used. Since the unshielded cable places a lower capacitive load on the FC, a longer cable length is possible in this case. Typically cable lengths that can be used are 50 m / 75 m (shielded) or 150 m /300 m (unshielded).

Not using shielded motor cables can only be recommended if other measures are taken. Even if an installation operates properly during its acceptance test without shielded motor cables, EMC problems can occur sporadically, or as a result of modifications or extensions to the installation. The financial expenditure then required to eliminate such problems is usually greater than the money saved by using unshielded cables.

When installing cables, care must be taken to avoid additional inductance resulting from routing cables in the form of an air-core coil and additional capacitance resulting from parallel conductors.

If several motors are connected in parallel to the output of a FC, the lengths of the individual motor cables must be added together to determine the connected cable length. Here it should be noted that some manufacturers specify geometrical addition of the individual cable lengths. In such cases, daisy-chaining the motor cable is advisable (Fig. 9.7 Total motor cable length is the sum of all connected parts). A star formation can cause problems due to the additional capacitance between the individual conductors.

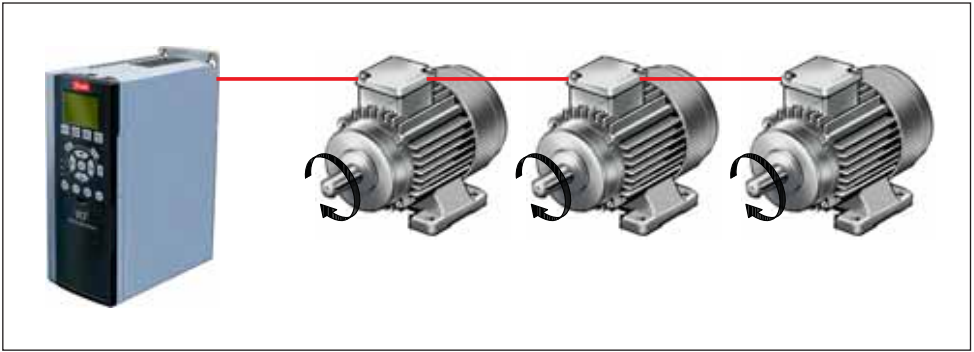

Fig. 9.7 Total motor cable length is the sum of all connected parts

9.8 Environment

Several considerations to the environment should be taken before installing a FC. The following factors should be checked:

- Ambient temperature
- Altitude
- Environment
- EMC
- Harmonic distortion

Minimum and maximum ambient temperature limits are specified for all FC's. Avoiding extreme ambient temperatures prolongs the life of the equipment and maximises overall system reliability. If the FC is installed in environment where the ambient temperature is higher than specified, derating of the power is needed, see Derating of FC.

The cooling capability of air is decreased at lower air pressure. Above 1000 m derating of FC's should be considered.

Electronic equipment is sensitive to the environment. For instance moisture, dust and temperature can all influence the reliability of electronics. Reduced reliability causes downtime in the application with reduced productivity as a result. Therefore it is important to choose the right solution for the actual application.

Basically, it is important to protect the electronics from a harsh environment. The best way to do that is to avoid the harsh environment by placing the electronics outside the harsh environment.

In most cases you cannot directly see how critical the environment is. It depends mainly on 4 factors, the concentration of pollutants present, dirt, the relative humidity

and temperature. Most FC manufacturers offer these solutions to minimize the effect of the environment:

- Mount the FC's in a central cabinet with long motor cables. In this way the FC's are remote from the critical environment
- Install air-conditioning in the control cabinet that ensures critical environment does not contact the FC's and other electronics. (Positive-pressure).
- Some FC's are fitted with a cold plate. With this solution you can place the FC inside a cabinet and via the cold plate the heat is transmitted to the outside. Then the FC's electronics are kept away from the critical environment
- Use a FC which is fitted with a sealed enclosure. FC manufacturers today offer an enclosure ingress protection up to IP66/Nema 4X which will protect the electronics from the outside environment and eliminates the cost of a separate enclosure
- Order the FC's with conformal coating which will significantly improve protection against chlorine, hydrogen sulphide, ammonia and other corrosive environments



Fig. 9.8 Printed circuit board with conformal coated

The FC is mostly used by professionals of the trade as a complex component forming part of a larger appliance, system, or installation. Therefore note that the responsibility for the final EMC and harmonics properties of the appliance, system or installation rests with the installer who has to ensure compliance with the local regulations.

For details about EMC and harmonics please refer to chapter 5 Electromagnetic Compatibility and chapter 7 Mains Interference.

9.9 Centralised versus Decentralised Installation

The most common form of installation is beyond doubt centralised installation of FC's in control cabinets. The advantages of centralised control cabinet technology lie, above all, in the protected installation of the units and centralised access to them for power, control, maintenance, and fault analysis.

With installation in the control cabinet, the primary aspect that must be taken into account is heat management, not only of the units but also of the whole installation. As a result of the heat dissipation in the control cabinet, additional cooling of the control cabinet may be necessary.

Depending on the FC manufacturer's mounting regulations, minimum distances must be maintained above and below the unit and between the unit and adjacent components. For better heat removal, direct mounting on the rear wall of the control cabinet is recommended. Some manufacturers also specify minimum distances between the individual units. It is however, preferable to mount the units side-by-side if possible in order to utilise mounting surface area effectively.

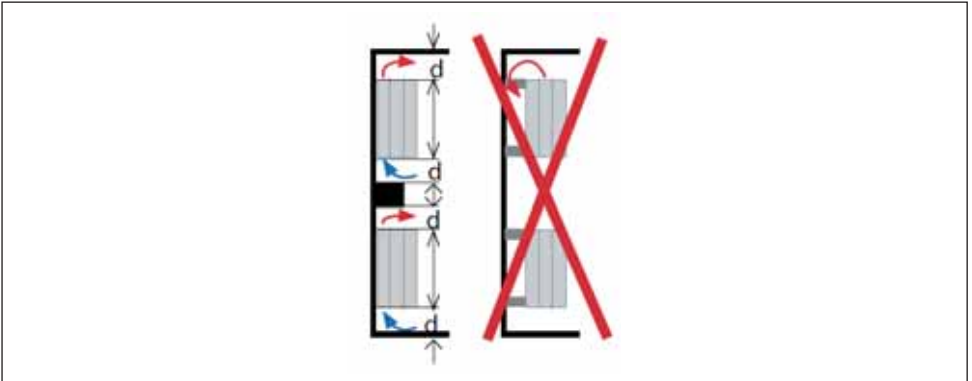

Fig. 9.9 Recommendations for mounting of converters (centralised solution)

A disadvantage of centralised installation in some cases is the long cable lengths to the motors. While the use of shielded cables definitely reduces the RFI effects of the motor cable, these effects are not completely eliminated.

As an alternative to centralised installation, a decentralised approach to the lay-out of a facility can also be chosen. Here the FC is located very close to or directly on the motor.

Motor cable lengths are thereby reduced to a minimum. In addition, decentralised installation offers advantages in fault detection, since the relationship between the

controllers and their associated motors is easy to see. In decentralised configurations, a field-bus is usually used to control the drives.

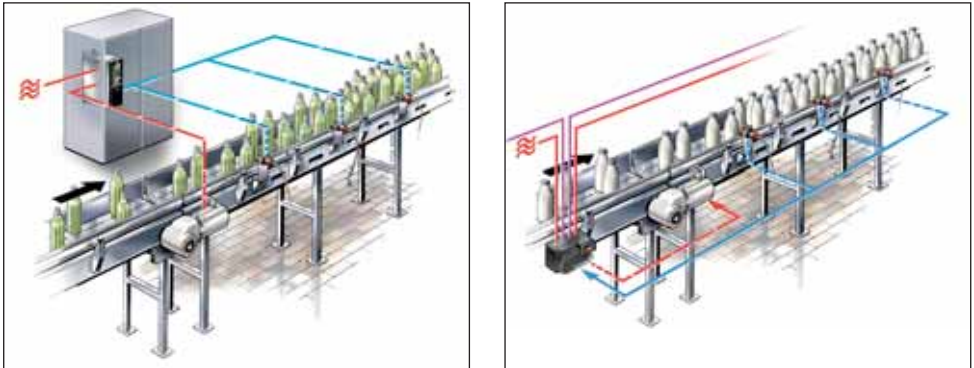

Fig. 9.10 Two concepts – different sets of benefits

When planning a decentralised installation, factors such as ambient temperatures, mains voltage drops, the limited motor cable lengths, etc. must be taken into account. Important factors such as these are often overlooked in the high-level design of engineering projects.

For example, not only the decentralised units but also the supply cables must be suitable for the installation environment. For instance the field-bus cable must be suitable for a harsher environment and sometimes also of the flexible type. In addition, installation of units in inaccessible locations should be avoided in order to ensure quick access for servicing.

Another major consideration is the segmentation of a decentralised network. For economic reasons it is beneficial to combine units into groups or segments. Careful consideration must be given to determining which segments require other segments for their operation, and which segments can, must, may, or should continue to operate autonomously. For example, if certain chemical processes cannot be interrupted, the failure of a lower-level segment must not be allowed to disrupt important segments.

Finally the expertise that is necessary for the installation of a decentralised network should not be underestimated. In addition to knowledge of the field-bus systems used, the technician must be aware of the structure (what happens to the total system if an individual unit fails) and the ambient conditions of a decentralised network and must be able to estimate these effects.

Although decentralised units are always more expensive than centralised units, well-conceived decentralisation concepts can achieve savings of around 25% compared

to centralised systems. The potential for savings in the installation arise from reduced cable lengths and from using equipment modules that have already been built and tested by the machine manufacturer or supplier.

9.10 Examples

The following examples illustrate the basic procedure for selecting a FC in the design process. Here the data sheet reproduced below is used for the selection process. The VLT® AutomationDrive FC 302 is selected as a FC that can operate with a 150m shielded cable.

		P11K		P15K		P18K		P22K	
		HO	NO	HO	NO	HO	NO	HO	NO
Output Current									
Continuous (380-440 V)	[A]	24	32	32	37.5	37.5	44	44	61
Intermittent (380-440V)	[A]	38.4	35.2	51.2	41.3	60	48.4	70.4	67.1
Continuous (441-500 V)	[A]	21	27	27	34	34	40	40	52
Intermittent (441-500 V)	[A]	33.6	29.7	43.2	37.4	54.4	44	64	57.2
Output Power									
Continuous (400 V)	[KVA]	16.6	22.2		26		30.5		42.3
Continuous (460 V)	[KVA]	21.5		27.1		31.9		41.4	
Typical shaft output	[kW]	11	15		18.5		22.0		30.0
Max. Input Current									
Continuous (380-440 V)	[A]	22	29		34		40		55
Intermittent (380-440V)	[A]	35.2	31.9	46.4	37.4	54.4	44	64	60.5
Continuous (441-500 V)	[A]	19	25		31		36		47
Intermittent (441-500 V)	[A]	30.4	27.5	40	34.1	49.6	39.6	57.6	51.7
Estimated power loss at rated max. load	[W]	291	392	379	465	444	525	547	739
Efficiency 0.98									
Max. cable size (mm ²)	([AWG ²])	16 (6)				35 (2)			
Max. pre-fuses	[A]	63				80			

Table 9.3 Data for the VLT® AutomationDrive

Example 1

A 15.0 kW, 3 x 400 V motor (4-pole) is installed together with a transport system (a screw conveyor with a break-away torque of approximately 160%). The current consumption of the motor is 30.0A in continuous operation.

Recommended solution 1

A VLT® AutomationDrive P15K (typical for a 15 kW motor with a high constant load torque) can supply 32 A in continuous operation and has sufficient excess load reserve (160 % / 60 s) to enable it to be used in this application.

Example 2

A 15.0 kW, 3 x 400 V motor (4-pole) is installed together with a centrifugal pump (break-away torque of approximately 60 %).

The current consumption of the motor is 30.0 A at its rated speed.

Recommended solution 2

A VLT® AutomationDrive P11K (typical for an 11 kW motor with a high constant load torque) can nevertheless supply 32 A with a nominal excess load torque of 110 % / 60 s (max.) and can therefore be used in this application. The unit also has tailored functions for additional energy savings.

Contributors:

John Bargmeyer, Michael Burghardt, Norbert Hanigovszki, Marie Louise Hansen, Anna Hildebrand Jensen, Johnny Wahl Jensen, Hans Seekjar, Ana-Mari Tataru-Kjar, Firuz Zare.

Danfoss can accept no responsibility for possible errors in catalogues, brochures and other printed material. Danfoss reserves the right to alter its products without notice. This also applies to products already on order provided that such alterations can be made without consequential changes being necessary in specifications already agreed. All trademarks in this material are property of the respective companies. Danfoss and the Danfoss logotype are trademarks of Danfoss A/S. All rights reserved.
