

MODEL 15T/H – INCREMENTAL ENCODER

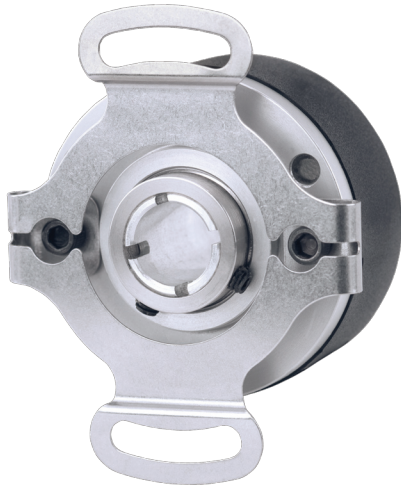

Ø1.5"

FEATURES

- High Performance Economical Encoder
- Low Profile – 1.0" (25.4 mm) Height and 1.5" (38 mm) Diameter
- Thru-Bore with sizes up to 0.375" (10 mm)
- Simple, Innovative Flex Mounting System (Global Mounting Standards)
- Up to 12 Pole Commutation Optional for Brushless Motor Control

The Model 15T or 15H Accu-Coder™ offers a high performance feedback solution in a low profile package. Unlike modular or kit encoders, the Model 15 utilizes an integral bearing set and an innovative flexible mounting system, which are much more tolerant to axial misalignment or radial shaft runout. The slotted flex mounts provide 20 to 30 degrees of rotational adjustment for commutation or index pulse timing. Installation is quick and easy; for brushless servo motor applications, three 120° electrical phase tracks can provide up to 12 pole commutation feedback. The optional 100° C and 120° C temperature options allow servo motors to operate at higher power outputs and duty cycles. With its stable and reliable operation, the Model 15 is an excellent replacement modular encoder when you need a high-performance solution.

COMMON APPLICATIONS

Servo Motor Control, Robotics, Specialty Assembly Machines, Digital Plotters, High Power Motors

MODEL 15T/H ORDERING GUIDE

Blue type indicates price adder options. Not all configuration combinations may be available. Contact Customer Service for details.

Mechanical				Electrical				Optional Features			
Leave Blank for Standard Options				Leave Blank for Standard Options				None Std			
15T	01	SF	0500	N	5	A	OC	F00			
MODEL 15T Thru-Bore 15H Hollow Bore	BORE SIZE¹ 15 3/16", 0.1875" 01 1/4", 0.250" 03 5/16", 0.3125" 02 3/8", 0.375" 08 4 mm 06 5 mm 04 6 mm 14 8 mm 05 10 mm	CYCLES PER REVOLUTION See CPR Options below Price adder for CPR>1999	INPUT VOLTAGE 5 5 VDC V1 5 to 28 VDC	COMMUTATION³ N No Commutation A 4 Pole B 6 Pole C 8 Pole E 10 Pole D 12 Pole	CONNECTOR TYPE⁷ F00 18" Cable ⁸ (Std) F01 12" Cable F02 24" Cable F03 36" Cable M00 2M Cable ⁹ J00 18" Cable with 5-pin M12 ¹⁰ K00 18" Cable with 8-pin M12 ¹⁰ A00 15-pin Header with 18" Cable ¹¹	OPERATING TEMPERATURE -20° to 85° C (Std) T1 -40° to 85° C T2 -20° to 100° C T3 -20° to 120° C ¹²	CERTIFICATION None (Std) CE CE Marked ¹³	OUTPUT TYPE OC Open Collector PP Push-Pull HV Line Driver PU Pull-Up Resistor ⁶ OD Open Collector with Differential Outputs <i>Available on special request.</i> <i>Additional lead times may apply:</i> LO Line Driver on ABZ Open Collector on UVW ⁶	MAXIMUM FREQUENCY Standard F3 Extended See Specifications	SEALING IP50 (Std) S1 IP64 for Thru-Bore & Blind Hollow Bore	
MOUNTING SF 1.812" (46 mm) Slotted Flex-Mount SA 1.812" (46 mm) Two Hole Flex Mount SB 1.142" (29 mm) Slotted Flex Mount ² SC 1.2795" (32.5 mm) Slotted Flex Mount ² SD 1.575" (40 mm) Slotted Flex Mount ²		NUMBER OF CHANNELS⁴ A Channel A Channel A Leads B Q Quadrature A & B R Quadrature A & B with Index Channel B Leads A⁵ K Reverse Quadrature A & B D Reverse Quadrature A & B with Index									

MODEL 15T/H CPR OPTIONS

0001 thru 0189	0198	0200	0250	0256	0300	0315	0360
0400	0500	0512	0580	0600	0750	0800	1000
1125	1200	1250	1500	1800	2000	2048	2500
3000	3600	4000	4096	5000	6000	7200	8192
							10,000

New CPR values are periodically added to those listed. Contact Customer Service to determine all currently available values. Special disk resolutions are available upon request and may be subject to a one-time NRE fee.

NOTES:

- Contact Customer Service for additional options not shown.
- This mount requires button head screws and a modified Hex wrench. Order appropriate Installation Kit listed under Specifications.
- Not available in all configurations, and not available with V1 Input Voltage. Contact Customer Service for availability.
- Contact Customer Service for non-standard index gating or phase relationship options.
- Reverse Quadrature not available with PU output type.
- With Input Voltage above 16 VDC, operating temperature is limited to 85° C.
- For mating connectors, cables, and cordsets see [Accessories](#) at [encoder.com](#). For Connector Pin Configuration Diagrams, see Technical Information or see [Connector Pin Configuration Diagrams](#) at [encoder.com](#).
- For non-standard English cable lengths enter 'F' plus cable length expressed in feet. Example: F06 = 6 feet of cable. Frequency above 300 kHz standard cable lengths only.
- For non-standard metric cable lengths enter 'M' plus cable length expressed in meters. Example: M06 = 6 meters of cable.
- Not available with commutation. 5-pin not available with Line Driver (HV, OD, LO) outputs. Additional cable lengths available. Please consult Customer Service.
- Pin Header available with 5 VDC Input Voltage, HV Line Driver and standard quadrature phasing only. Not available with CE Certification. IP50 sealing option only.
- Only available with 5 VDC Input Voltage.
- Please refer to Technical Bulletin [TB100: When to Choose the CE Mark](#) at [encoder.com](#)

MODEL 15T/H SPECIFICATIONS

Electrical

Input Voltage..... 5 VDC $\pm 10\%$ Fixed Voltage
 4.75 to 28 VDC max for temperatures up to 85° C
 4.75 to 24 VDC for temperatures between 85° and 100° C

Input Current 140 mA max (65 mA typical for most configurations) with no output load

Output Format..... Incremental – Two square waves in quadrature with channel A leading B for clockwise shaft rotation, as viewed from the encoder mounting face. See *Waveform Diagrams*.

Output Types..... Open Collector – 20 mA max per channel
 Push-Pull – 20 mA max per channel
 Pull-Up – Open Collector with 2.2K ohm internal resistor, 20 mA max per channel
 Line Driver – 20 mA max per channel (Meets RS 422 at 5 VDC supply)

Index..... Once per revolution
 1 to 189 CPR: Ungated
 190 to 10,000 CPR: Gated to output A See *Waveform Diagrams*.

Max. Frequency Standard Frequency Response is 200 kHz for CPR 1 to 2540
 500 kHz for CPR 2541 to 5000
 1 MHz for CPR 5001 to 10,000
 Extended Frequency Response (optional) is 300 kHz for CPR 2000, 2048, 2500, and 2540

Electrical Protection .. Reverse voltage and output short circuit protected. NOTE: Sustained reverse voltage may result in permanent damage.

Noise Immunity..... Tested to BS EN61000-6-2; BS EN50081-2; BS EN61000-4-2; BS EN61000-4-3; BS EN61000-4-6; BS EN500811

Quadrature..... 67.5° electrical or better is typical,
 Edge Separation 54° electrical minimum at temperatures > 99° C

Waveform Symmetry... 180° ($\pm 18^\circ$) electrical (single channel encoder)

Accuracy..... Within 0.017° mechanical or 1 arc-minute from true position (for CPR > 189)

Commutation..... Up to 12 pole. Contact Customer Service for availability.

Comm. Accuracy 1° mechanical

Mechanical

Max Shaft Speed 8000 RPM. Higher speeds may be achievable, contact Customer Service.

Bore Tolerance -0.0000" / +0.0006"

User Shaft Tolerances
 Radial Runout 0.008" max
 Axial Endplay..... ± 0.030 " max

Starting Torque IP50 Hollow Bore: 0.2 oz-in
 IP50 Thru-Bore: 0.3 oz-in
 IP64: 0.6 oz-in

Moment of Inertia ... 6.7×10^{-5} oz-in-sec² (4.8 gm-cm²)

Weight..... 3 oz typical

Environmental

Storage Temp -25° to 85° C
 Humidity..... 98% RH non-condensing
 Vibration..... 10 g @ 58 to 500 Hz
 Shock..... 80 g @ 11 ms duration
 Sealing..... IP50 standard; IP64 available

MODEL 15T/H 1.811" (46 MM) SLOTTED FLEX MOUNT (SF)

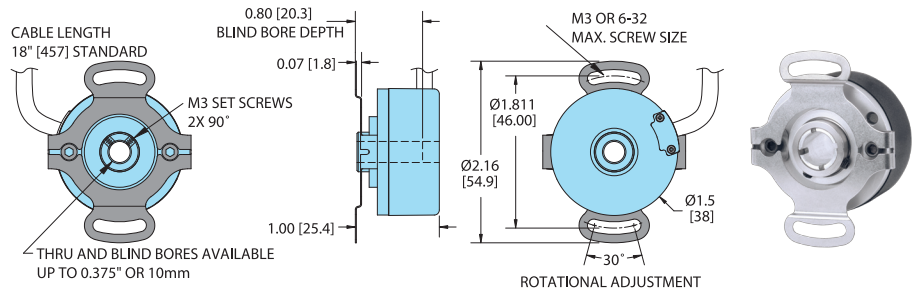

MODEL 15T/H 1.811" (46 MM) TWO HOLE FLEX MOUNT (SA)

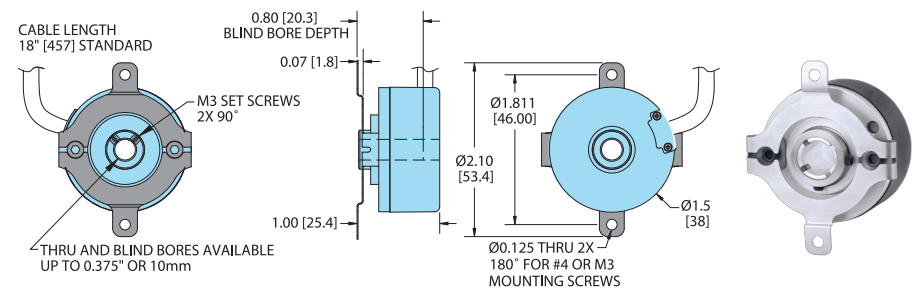

MODEL 15T/H SMALL DIAMETER SLOTTED FLEX MOUNTS

1.142" (29 mm) SB*

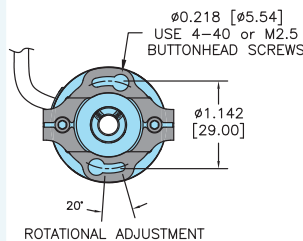

1.2795" (32.5 mm) SC*

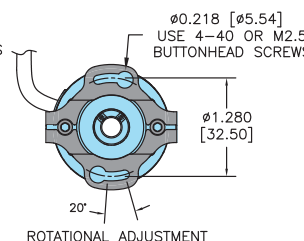

1.575" (40 mm) SD*

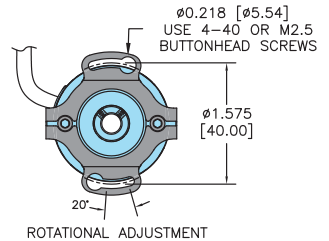

*Order Appropriate No Charge Mounting and Installation Kit for SB, SC, or SD Option. Each kit contains 10 screws for mounting 5 encoders.

- 176150-01** Installation Kit, 4-40 Buttonhead Screws with 0.062" Shortened Hex Wrench
- 176149-01** Installation Kit, M2.5 Buttonhead Screws with 1.5 mm Shortened Hex Wrench

Encoder length and diameter are the same as SF and SA mounts detailed above. All dimensions are in inches with a tolerance of ± 0.005 " or ± 0.01 " unless otherwise specified. Metric dimensions are given in brackets [mm].



SB Slotted Flex Mount

WIRING TABLE

For EPC-supplied mating cables, refer to wiring table provided with cable.

Trim back and insulate unused wires.

Function	Flying Leads Cable† Wire Color	5-pin M12**	8-pin M12**	15-pin Header
Com	Black	3	7	1
+VDC	White	1	2	2
A	Brown	4	1	4
A'	Yellow	--	3	3
B	Red	2	4	6
B'	Green	--	5	5
Z	Orange	5	6	7
Z'	Blue	--	8	8
U	Violet	--	--	10
U'	Gray	--	--	9
V	Pink	--	--	14
V'	Tan	--	--	13
W	Red/Green	--	--	12
W'	Red/Yellow	--	--	11
Shield	Bare*	--	--	--

15-pin Header

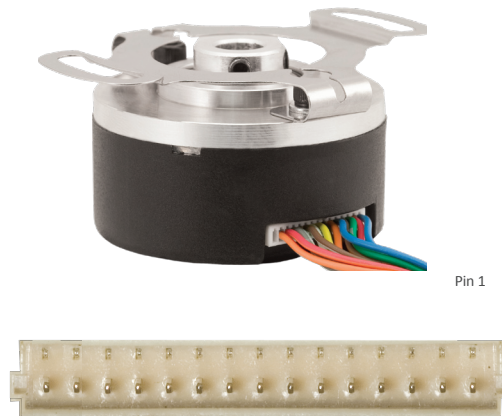

*CE Option: Cable shield (bare wire) is connected to internal case.

†Standard cable for non-commutated models is 24 AWG For commutated units, conductors are 28 AWG.

**CE Option: Use cable cordset with shield connected to M12 connector coupling nut.

WAVEFORM DIAGRAMS

Incremental Signals

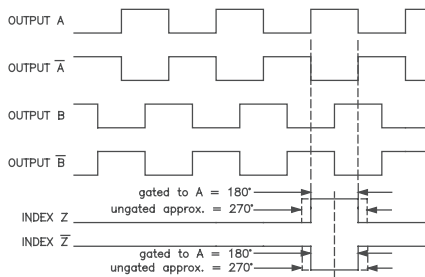

Commutation Signals

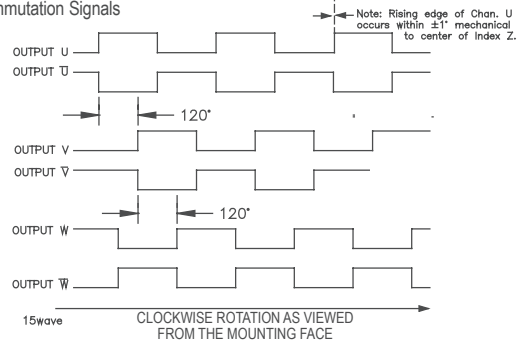

NOTE: ALL DEGREE REFERENCES ARE ELECTRICAL DEGREES. WAVEFORM SHOWN WITH OPTIONAL COMPLEMENTARY SIGNALS A', B', Z' FOR HV AND OD OUTPUTS ONLY.