

MODEL 702 – INCREMENTAL SHAFT ENCODER



Ø2.0"

FEATURES

- Standard Size 20 Package (2x2)
- Flange and Servo Mounting
- Up to 30,000 CPR
- 80 lb Maximum Axial and Radial Shaft Loading
- IP67 Sealing Available

The Model 702 Size 20 Accu-Coder™ is a heavy duty, extremely rugged, reliable, yet compact industry standard 2" diameter encoder, designed for harsh factory and plant floor environments. The double shielded ball bearings are rated at 80 lb maximum axial and radial shaft loading to ensure a long operating life. Made to withstand the harsh effects of the real world, both the flange and servo models are rated IP67 with the optional heavy duty shaft seal. With a variety of mounting options in both the flange and servo models, the Model 702 is ideal for both new applications and replacements. If you need an encoder that won't let you down, the Model 702 is it.

COMMON APPLICATIONS

- Motion Control Feedback, Conveyors, Elevator Controls,
- Machine Control, Food Processing, Process Control, Robotics,
- Material Handling, Textile Machines

MODEL 702 ORDERING GUIDE

Blue type indicates price adder options. Not all configuration combinations may be available. Contact Customer Service for details.

702	20	S	1000	R	HV	1	F	1	E	X	N	CE
MODEL 702 Size 20 (2.0")	OPERATING TEMPERATURE S 0° to 70° C L -40° to 70° C H 0° to 100° C ³	OUTPUT TYPE 5 - 28V In/Out ⁵ OC Open Collector PU Pull-Up Resistor PP Push-Pull HV Line Driver ⁶ 8 - 28V In/5V Out ^{7,8} H5 Line Driver ⁶ P5 Push-Pull	SEALING N No Seal 1 IP66 2 IP64 5 IP67	CONNECTOR LOCATION E End S Side	MATING CONNECTOR N No Y Yes	CERTIFICATION N None CE CE Marked ¹²	SHAFT SIZE¹ 07 1/4", 0.250" 20 3/8", 0.375" 21 10 mm 30 3/8", 0.375" ² 24 1/4", 0.250" No Flat	CYCLES PER REVOLUTION 1-30,000 See CPR Options below for available resolutions. Price adder for CPR >1270	MAXIMUM FREQUENCY 1 100 kHz (Standard) 2 200 kHz 5 250 kHz, >3000 CPR 3 500 kHz, >6000 CPR ⁹ 4 1 MHz, >10,000 CPR ⁹	MOUNTING Flange Mounts F 1.181" Female Pilot L 0.687" Male Pilot G 1.250" Male Pilot K Size 25 w/30 Shaft Servo Mounts S w/1.181" Female Pilot U S w/0.687" Male Pilot T S w/1.250" Male Pilot C w/1.181" Female Pilot E C w/0.687" Male Pilot D C w/1.250" Male Pilot P w/1.181" Female Pilot Q P w/0.687" Male Pilot R P w/1.250" Male Pilot J Size 25 w/30 Shaft	CONNECTOR TYPE¹⁰ W 6-pin MS ⁶ Y 7-pin MS ⁶ X 10-pin MS 9D 9-pin D-subminiature J 5-pin M12 (12 mm) ⁶ K 8-pin M12 (12 mm) G Gland, 24" Cable ¹¹ H 10-pin Bayonet	NUMBER OF CHANNELS⁴ A Channel A Channel A Leads B Q Quadrature A & B R Quadrature A & B with Index Channel B Leads A K Reverse Quadrature A & B D Reverse Quadrature A & B with Index

MODEL 702 CPR OPTIONS

0001*	0002*	0004*	0005*	0006*	0007*	0008*	0010*	0011*
0012*	0014*	0020	0021*	0024*	0025*	0028*	0030*	0032*
0033*	0034*	0035*	0038*	0040*	0042*	0045*	0050*	0060
0064*	0100	0120	0125	0128*	0144*	0150*	0160*	0192*
0200	0240*	0250	0254*	0256*	0300	0333*	0336	0360
0400	0500	0512	0600	0625*	0635	0665*	0720	0768*
0800	0889	0900*	1000	1024	1200	1201* ^a	1203* ^a	1204* ^a
1250 ^a	1270 ^a	1440	1500	1800	2000	2048	2400 ^a	2500
2540 ^a	2880 ^a	3000 ^a	3600 ^a	4000 ^a	4096 ^a	5000 ^a	6000 ^a	7200 ^a
7500 ^a	9000 ^a	10,000 ^a	10,240 ^a	12,000 ^a	12,500 ^a	14,400 ^a	15,000 ^a	
18,000 ^a	20,000 ^a	20,480 ^a	25,000 ^a	30,000 ^a				

*Contact Customer Service for High Temperature Option.

^aHigh Temperature Option (H) limited to 85° C maximum for these CPR options.

New CPR values are periodically added to those listed. Contact Customer Service to determine all currently available CPR values. Special disk resolutions are available upon request. A one-time NRE fee may apply.

NOTES:

- Contact Customer Service for additional options.
- Shaft with Size 25 Mounting Adapter, J or K mounting only.
- 0° to 85° C for certain resolutions, see CPR Options.
- Contact Customer Service for non-standard index gating options.
- 24 VDC max for high temperature option.
- Line Driver not available with 5-pin M12 or 6-pin MS connector. Available with 7-pin MS connector only without Index Z.
- Standard temperature, 60 to 3000 CPR only.
- H5 and P5 outputs are not available with CE option, or any End Mount MS Connector.
- Standard cable lengths only. For details, please refer to Technical Bulletin [TB116: Noise and Signal Distortion Considerations](#) at encoder.com.
- For mating connectors, cables, and cordsets see [Accessories](#) at encoder.com. For Connector Pin Configuration Diagrams, see Technical Information or see [Connector Pin Configuration Diagrams](#) at encoder.com.
- For non-standard cable lengths, add a forward slash (/) plus cable length expressed in feet. Example: G/6 = 6 feet of cable.
- Please refer to Technical Bulletin [TB100: When to Choose the CE Mark](#) at encoder.com.

MODEL 702 SPECIFICATIONS

Electrical

Input Voltage..... 4.75 to 28 VDC max for temperatures up to 70° C
4.75 to 24 VDC for temperatures between 70° C and 100° C

Input Current 100 mA max with no output load
Input Ripple 100 mV peak-to-peak at 0 to 100 kHz

Output Format..... Incremental – Two square waves in quadrature with channel A leading B for clockwise shaft rotation, as viewed from the encoder mounting face.
See *Waveform Diagrams*.

Output Types Open Collector – 100 mA max per channel
Pull-Up – Open Collector with 2.2K ohm internal resistor, 100 mA max per channel
Push-Pull – 20 mA max per channel
Line Driver – 20 mA max per channel
(Meets RS 422 at 5 VDC supply)

Index Occurs once per revolution. The index for units >3000 CPR is 90° gated to Outputs A and B. See *Waveform Diagrams*.

Max Frequency..... Up to 1 MHz

Electrical Protection .. Reverse voltage and output short circuit protected. NOTE: Sustained reverse voltage may result in permanent damage.

Noise Immunity Tested to BS EN61000-4-2; IEC801-3; BS EN61000-4-4; DDENV 50141; DDENV 50204; BS EN55022
(with European compliance option); BS EN61000-6-2; BS EN50081-2

Symmetry 1 to 6000 CPR: 180° (±18°) electrical at 100 kHz output

6001 to 20,480 CPR: 180° (±36°) electrical
Quad Phasing..... 1 to 6000 CPR: 90° (±22.5°) electrical at 100 kHz output

6001 to 20,480 CPR: 90° (±36°) electrical
Min Edge Sep..... 1 to 6000 CPR: 67.5° electrical at 100 kHz output
6001 to 20,480 CPR: 54° electrical
>20,480 CPR: 50° electrical

Rise Time Less than 1 microsecond

Accuracy..... Instrument and Quadrature Error: For 200 to 1999 CPR, 0.017° mechanical (1.0 arc minutes) from one cycle to any other cycle. For 2000 to 3000 CPR, 0.01° mechanical (0.6 arc minutes) from one cycle to any other cycle. Interpolation error (units > 3000 CPR only) within 0.005° mechanical. (Total Optical Encoder Error = Instrument + Quadrature + Interpolation)

Mechanical

Max Shaft Speed 8000 RPM. Higher shaft speeds may be achievable, contact Customer Service.

Shaft Rotation..... Bi-directional

Radial Shaft Load..... 80 lb max. Rated load of 20 to 40 lb for bearing life of 1.5×10^9 revolutions

Axial Shaft Load..... 80 lb max. Rated load of 20 to 40 lb for bearing life of 1.5×10^9 revolutions

Starting Torque 1.0 oz-in typical with IP64 seal or no seal
3.0 oz-in typical with IP66 shaft seal
7.0 oz-in typical with IP67 shaft seal

Moment of Inertia.... 5.2×10^{-4} oz-in-sec²

Housing..... Black non-corrosive finish

Bearings..... Precision ABEC ball bearings

Weight..... 11 oz typical

Environmental

Storage Temp -25° to 85° C

Humidity..... 98% RH non-condensing

Vibration..... 20 g @ 58 to 500 Hz

Shock..... 75 g @ 11 ms duration

Sealing..... IP50 standard; IP64, IP66 or IP67 optional

MODEL 702 2.0" SERVO MOUNT (S)

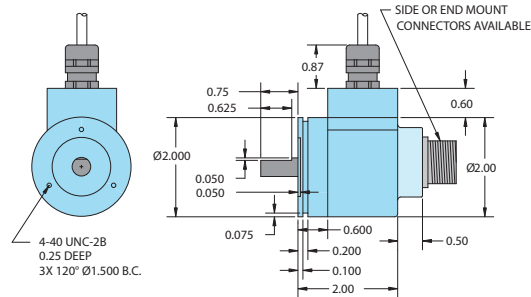

MODEL 702 2.0" SERVO MOUNT (C)

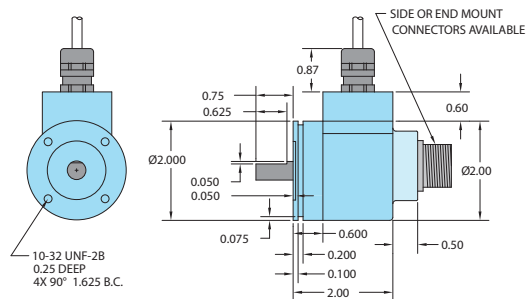

MODEL 702 2.0" SERVO MOUNT (P)

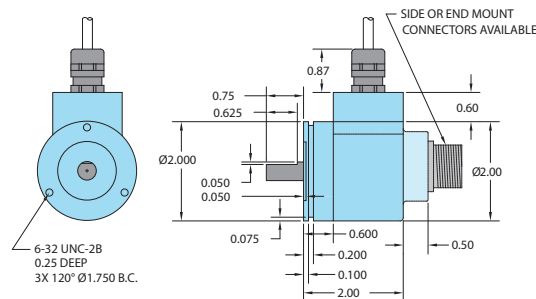

OPTIONAL PILOTS FOR FLANGE AND SERVO MOUNTS

(G, T, D, R)

(L, U, E, Q)

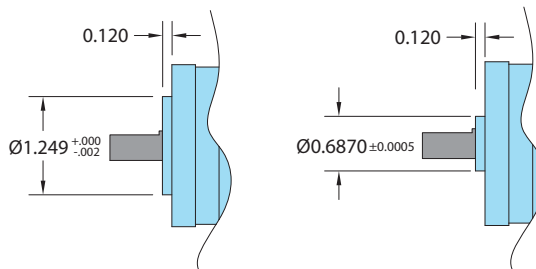

All dimensions are in inches with a tolerance of ± 0.005 " or ± 0.01 " unless otherwise specified.

MODEL 702 2.0" FLANGE MOUNT (F)

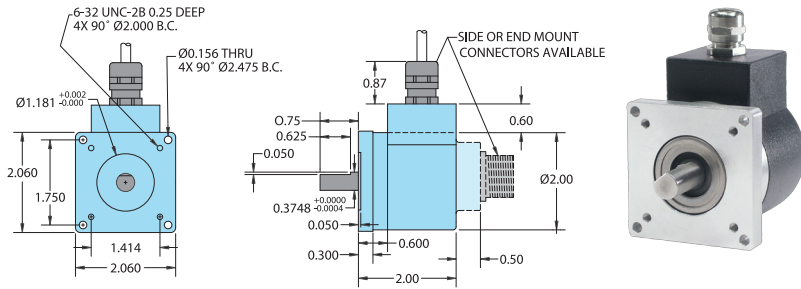

MODEL 702 WITH 2.5" FLANGE MOUNT (K)

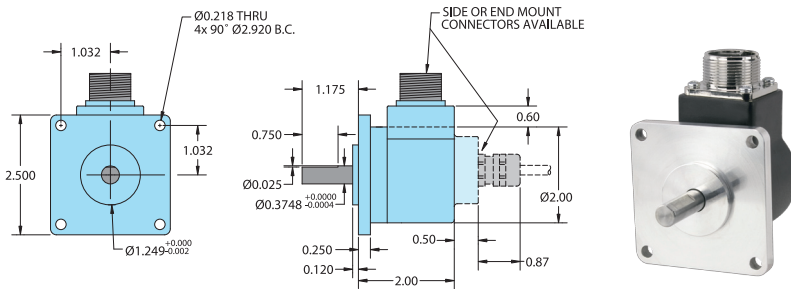

MODEL 702 WITH 2.5" SERVO MOUNT (J)

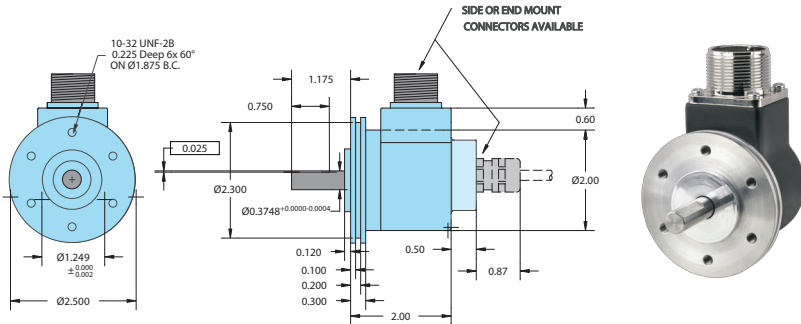

All dimensions are in inches with a tolerance of ± 0.005 " or ± 0.01 " unless otherwise specified.

WIRING TABLE

For EPC-supplied mating cables, refer to wiring table provided with cable.

Trim back and insulate unused wires.

Function	Gland Cable† Wire Color	5-pin M12**	8-pin M12**	10-Pin MS	7-pin MS HV,H5	7-pin MS PU,PP, OC,P5	6-pin MS PU,PP OC,P5	9-pin D-sub	10-pin Bayonet
Com	Black	3	7	F	F	F	A,F	9	F
+VDC	Red	1	2	D	D	D	B	1	D
A	White	4	1	A	A	A	D	2	A
A'	Brown	--	3	H	C	--	--	3	H
B	Blue	2	4	B	B	B	E	4	B
B'	Violet	--	5	I	E	--	--	5	J
Z	Orange	5	6	C	--	C	C	6	C
Z'	Yellow	--	8	J	--	--	--	7	K
Case	Green	--	--	G	G	G	--	8	G
Shield	Bare*	--	--	--	--	--	--	--	--

WAVEFORM DIAGRAMS

Line Driver and Push-Pull

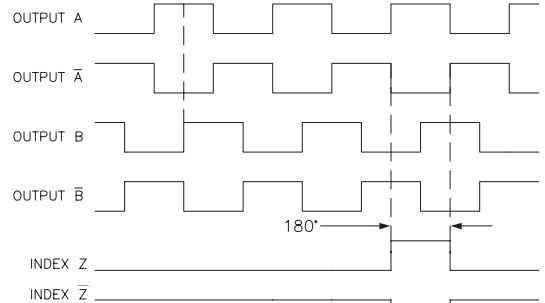

CLOCKWISE ROTATION AS VIEWED FROM THE MOUNTING FACE

NOTE: ALL DEGREE REFERENCES ARE ELECTRICAL DEGREES.
WAVEFORM SHOWN WITH OPTIONAL COMPLEMENTARY SIGNALS
A, B, Z FOR HV OUTPUT ONLY.

Open Collector and Pull-Up

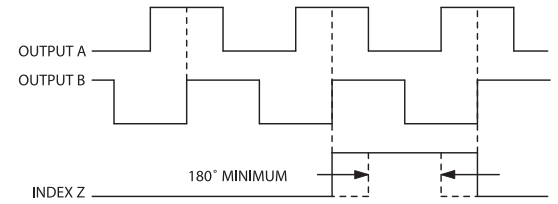

CLOCKWISE ROTATION AS VIEWED FROM THE MOUNTING FACE

NOTE: ALL DEGREE REFERENCES ARE ELECTRICAL DEGREES.
INDEX IS POSITIVE GOING.