

### Features

- Pilot operated, normally open or normally closed
- Snubber slows disc closing speed to protect system against water hammer damage more effectively than other techniques
- Pressure spike due to water hammer is reduced to a point eliminating the need for suppressors or other controls in most water systems
- Fluid Controls Institute Inc. evaluations have classified these valves:

Pipe Sizes	FCI-82-1 Class
3/8", 1/2", 3/4"	CC
1", 1 1/4", 1 1/2", 2", 2 1/2"	BB

### Construction

Valve Parts in Contact with Fluids	
Body	Brass
Disc	NBR
Seals	PTFE & NBR
Core Tube	305 Stainless Steel
Core and Plugnut	430F Stainless Steel
Springs	302 Stainless Steel
Piston	Stainless Steel or Brass
Shading Coil	Copper

### Electrical

Standard Coil and Class of Insulation	Watt Rating and Power Consumption				Spare Coil Part No.			
	DC Watts	AC			General Purpose		Explosionproof	
		Watts	VA Holding	VA Inrush	AC	DC	AC	DC
F	11.6	6.1	16	30	238210	238710	238214	238714
F	16.8	16.1	35	95	272610	97617	272614	97617
F	22.6	-	-	-	-	238710	-	238714

**Standard Voltages:** 24, 120, 240, 480 volts AC, 60 Hz (or 110, 220 volts AC, 50 Hz).  
6, 12, 24, 120, 240 volts DC. Must be specified when ordering.  
Other voltages are available when required.

### Solenoid Enclosures

**Standard:** RedHat II - Watertight, Types 1, 2, 3, 3S, 4, and 4X; RedHat - Type I.

**Optional:** RedHat II - Explosionproof and Watertight, Types 3, 3S, 4, 4X, 6, 6P, 7, and 9; RedHat - Explosionproof and Raintight, Types 3, 7, and 9. (To order, add prefix "EF" to catalog number.)

See *Optional Features Section* for other available options.

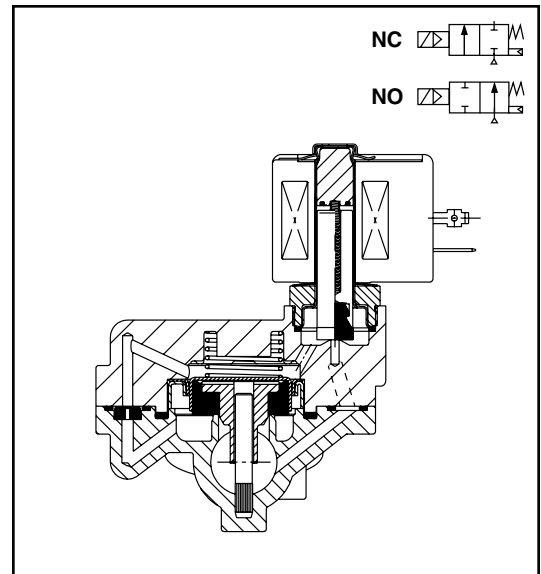

### Nominal Ambient Temp. Ranges:

- RedHat II/
- RedHat AC: 32°F to 125°F (0°C to 52°C)
- RedHat II DC: 32°F to 104°F (0°C to 40°C)
- RedHat DC: 32°F to 77°F (0°C to 25°C)  
(104°F/40°C occasionally)

Refer to *Engineering Section* for details.

### Approvals:

- CSA certified (Excludes 8221G015, -035, -G035).
- UL listed, General Purpose Valves.
- RedHat II meets applicable CE directives.

Refer to *Engineering Section* for details.

## Specifications (English units)

Pipe Size (in)	Orifice Size (in)	Cv Flow Factor	Operating Pressure Differential (psi)			Max. Fluid Temp. °F		Brass Body Catalog Number	Const. Ref.	Watt Rating/ Class of Coil Insulation ③	
			Min. ①	Max. AC	Max. DC	AC	DC			AC	DC
				Water ②	Water ②						
<b>NORMALLY CLOSED (Closed when de-energized)</b>											
3/8	9/16	3	5	150	125	180	150	8221G001	1	6.1/F	11.6/F
1/2	9/16	3.5	5	150	125	180	150	8221G003	1	6.1/F	11.6/F
3/4	3/4	5.5	5	150	125	180	150	8221G005	2	6.1/F	11.6/F
1	1	11.5	5	150	125	180	150	8221G007	5	6.1/F	11.6/F
1 1/4	1 1/8	13	5	150	125	180	150	8221G009	6	6.1/F	11.6/F
1 1/2	1 1/4	24	5	150	125	180	150	8221G011	7	6.1/F	11.6/F
2	1 3/4	36	5	150	125	180	150	8221G013	11	6.1/F	22.6/F
2 1/2	1 3/4	38	5	150	125	180	150	8221G015 ④	12	6.1/F	22.6/F
<b>NORMALLY OPEN (Open when de-energized)</b>											
3/8	9/16	3	5	-	125	-	150	8221 021	15	-	16.8/F
3/8	9/16	3	5	150	-	180	-	8221G021	3	16.1/F	-
1/2	9/16	3.5	5	-	125	-	150	8221 023	15	-	16.8/F
1/2	9/16	3.5	5	150	-	180	-	8221G023	3	16.1/F	-
3/4	3/4	5.5	5	-	125	-	150	8221 025	16	-	16.8/F
3/4	3/4	5.5	5	150	-	180	-	8221G025	4	16.1/F	-
1	1	11.5	5	-	125	-	150	8221 027	17	-	16.8/F
1	1	11.5	5	150	-	180	-	8221G027	8	16.1/F	-
1 1/4	1 1/8	13	5	-	125	-	150	8221 029	18	-	16.8/F
1 1/4	1 1/8	13	5	150	-	180	-	8221G029	9	16.1/F	-
1 1/2	1 1/4	24	5	-	125	-	150	8221 031	19	-	16.8/F
1 1/2	1 1/4	24	5	150	-	180	-	8221G031	10	16.1/F	-
2	1 3/4	36	5	-	125	-	150	8221 033	20	-	16.8/F
2	1 3/4	36	5	150	-	180	-	8221G033	13	16.1/F	-
2 1/2	1 3/4	38	5	-	125	-	150	8221 035 ④	21	-	16.8/F
2 1/2	1 3/4	38	5	150	-	180	-	8221G035 ④	14	16.1/F	-

① Valves require a 5 psi Minimum Pressure Differential to open. Once open, they remain open with 3 psi differential pressure.  
 ② Refer to Steam/Hot Water Valve Series for Hot Water constructions.  
 ③ On 50 hertz service, the watt rating for the 6.1/F solenoid is 8.1 watts.  
 ④ Not CSA certified.

### Specifications (Metric units)

Pipe Size (in)	Orifice Size (mm)	Kv Flow Factor (m3/h)	Operating Pressure Differential (bar)			Max. Fluid Temp. °C		Brass Body	Const. Ref.	Watt Rating/ Class of Coil Insulation ③	
			Min. ①	Max. AC	Max. DC	AC	DC			Catalog Number	AC
				Water ②	Water ②						
<b>NORMALLY CLOSED (Closed when de-energized)</b>											
3/8	14	2.6	0.3	10	9	82	65	8221G001	1	6.1/F	11.6/F
1/2	14	3.0	0.3	10	9	82	65	8221G003	1	6.1/F	11.6/F
3/4	19	4.7	0.3	10	9	82	65	8221G005	2	6.1/F	11.6/F
1	25	9.9	0.3	10	9	82	65	8221G007	5	6.1/F	11.6/F
1 1/4	29	11	0.3	10	9	82	65	8221G009	6	6.1/F	11.6/F
1 1/2	32	21	0.3	10	9	82	65	8221G011	7	6.1/F	11.6/F
2	44	31	0.3	10	9	82	65	8221G013	11	6.1/F	22.6/F
2 1/2	44	33	0.3	10	9	82	65	8221G015 ④	12	6.1/F	22.6/F
<b>NORMALLY OPEN (Open when de-energized)</b>											
3/8	14	2.6	0.3	-	9	-	65	8221 021	15	-	16.8/F
3/8	14	2.6	0.3	10	-	82	-	8221G021	3	16.1/F	-
1/2	14	3.0	0.3	-	9	-	65	8221 023	15	-	16.8/F
1/2	14	3.0	0.3	10	-	82	-	8221G023	3	16.1/F	-
3/4	19	4.7	0.3	-	9	-	65	8221 025	16	-	16.8/F
3/4	19	4.7	0.3	10	-	82	-	8221G025	4	16.1/F	-
1	25	9.9	0.3	-	9	-	65	8221 027	17	-	16.8/F
1	25	9.9	0.3	10	-	82	-	8221G027	8	16.1/F	-
1 1/4	29	11	0.3	-	9	-	65	8221 029	18	-	16.8/F
1 1/4	29	11	0.3	10	-	82	-	8221G029	9	16.1/F	-
1 1/2	32	21	0.3	-	9	-	65	8221 031	19	-	16.8/F
1 1/2	32	21	0.3	10	-	82	-	8221G031	10	16.1/F	-
2	44	31	0.3	-	9	-	65	8221 033	20	-	16.8/F
2	44	31	0.3	10	-	82	-	8221G033	13	16.1/F	-
2 1/2	44	33	0.3	-	9	-	65	8221 035 ④	21	-	16.8/F
2 1/2	44	33	0.3	10	-	82	-	8221G035 ④	14	16.1/F	-

① Valves require a 0.3 bar Minimum Pressure Differential to open. Once open, they remain open with 0.2 bar differential pressure.  
 ② Refer to Steam/Hot Water Valve Series for Hot Water constructions.  
 ③ On 50 hertz service, the watt rating for the 6.1/F solenoid is 8.1 watts.  
 ④ Not CSA certified.

Dimensions: inches (mm)

Const. Ref.		H	K	L	P	W
1	in	4.34	2.69	2.72	3.59	3.41
	mm	110	68	69	91	87
2	in	4.53	2.85	2.78	3.75	3.41
	mm	115	72	71	95	87
3	in	5.22	3.14	2.72	4.47	3.69
	mm	133	80	69	114	94
4	in	5.41	3.30	2.78	4.62	3.69
	mm	137	84	71	117	94
5	in	5.62	3.15	3.75	4.03	3.16
	mm	143	80	95	102	80
6	in	5.56	3.15	3.66	4.03	3.56
	mm	141	80	93	102	90
7	in	6.12	3.30	4.38	4.19	4.12
	mm	156	84	111	106	105
8	in	6.53	3.59	3.75	4.91	3.16
	mm	166	91	95	125	80
9	in	6.47	3.59	3.56	4.91	3.56
	mm	164	91	93	125	90
10	in	7.03	3.74	4.38	5.06	4.12
	mm	179	95	111	129	105
11	in	7.38	3.71	5.06	4.59	4.72
	mm	188	94	129	117	120
12	in	7.38	3.71	5.50	4.59	5.19
	mm	188	94	140	117	132
13	in	8.22	4.15	5.06	5.47	4.72
	mm	209	105	129	139	120
14	in	8.22	4.15	5.50	5.47	5.19
	mm	209	105	140	139	132
15	in	5.22	-	2.72	4.47	3.69
	mm	133	-	69	114	94
16	in	5.41	-	2.78	4.62	3.69
	mm	137	-	71	117	94
17	in	6.53	-	3.75	4.91	3.16
	mm	166	-	95	125	80
18	in	6.47	-	3.66	4.91	3.56
	mm	164	-	93	125	90
19	in	7.03	-	4.38	5.06	4.12
	mm	179	-	111	129	105
20	in	8.22	-	5.06	5.47	4.72
	mm	209	-	129	139	120
21	in	8.22	-	5.50	5.47	5.19
	mm	209	-	140	139	132

**IMPORTANT:** Valves may be mounted in any position.

Const. Ref. 1, 2

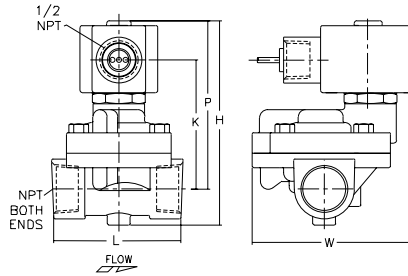

Const. Ref. 3, 4

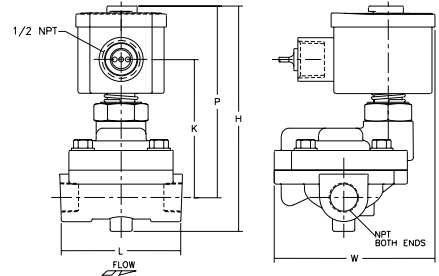

Const. Ref. 5, 6

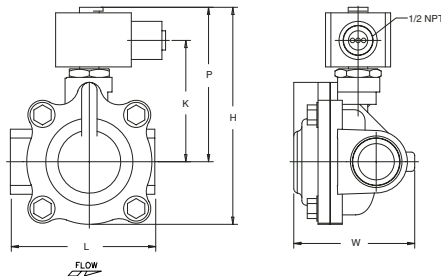

Const. Re. 7, 11, 12

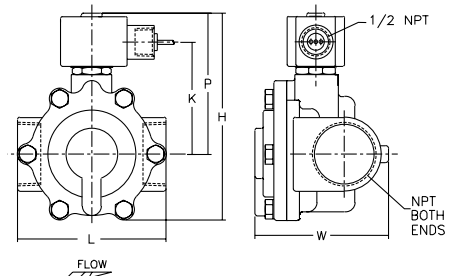

Const. Ref. 8, 9, 10, 13, 14

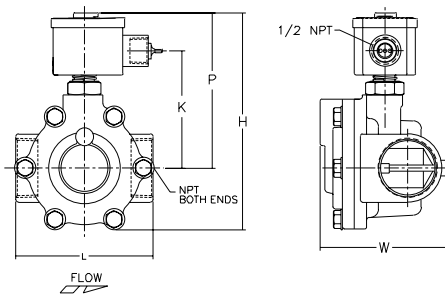

Const. Ref. 15, 16

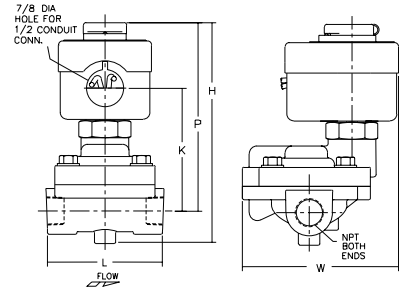

Const. Ref. 17 - 21

