

S3Z SERIES

The high operating distances and cost-effective price, makes the S3Z series in the miniature format with dimensions and standard fixing affirmed in the market, in particular in Far-East. Different models are available: 15m through beam, 4m polarised retroreflex, 2m polarized for transparent, 70 cm diffuse proximity, narrow beam from 50 to 150mm and 5 to 30cm background suppression model with multi-turn mechanical trimmer setting. Also available LASER models class I: 30m through beam, 10m polarised retroreflex and 40 to 300mm background suppression. Versions with NPN or PNP output, with dark or light operating mode and with cable or M8 connection are available. The plastic housing is completely overprinted, guaranteeing maximum mechanical protection also in presence of frequent washing.

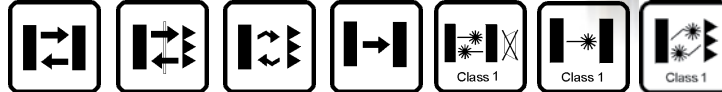

HIGHLIGHTS

- Complete range of optic function LED or LASER emission
- 2m polarized for transparent detection
- 40-300 mm background suppression with both LASER or LED technology emission
- 1m long diffused, 15 cm diffused narrow beam
- 4 m polarised retroreflex or 10m LASER model
- 15 m through beam or 30m Laser model
- Standard 3 wire output configuration
- IP67 mechanical protection
- Interference prevention allows two units to be mounted side by side

APPLICATIONS

Automotive



Beverage & Bottling



Packaging lines



INDICATORS AND SETTING

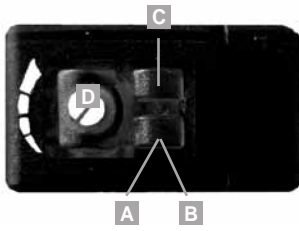

- A** Output status LED
- B** Power on LED (S3Z ... G00)
- C** Stability LED
- D** Sensitivity trimmer
- E** Cable output
- F** M8 connector output

DIMENSIONS

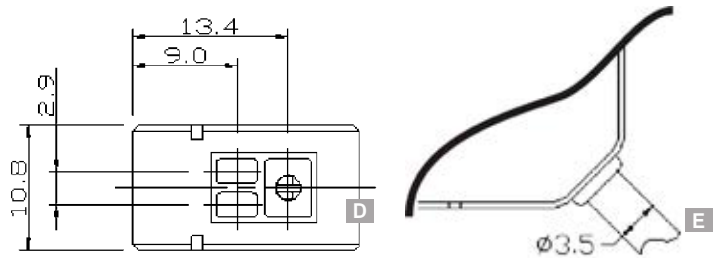
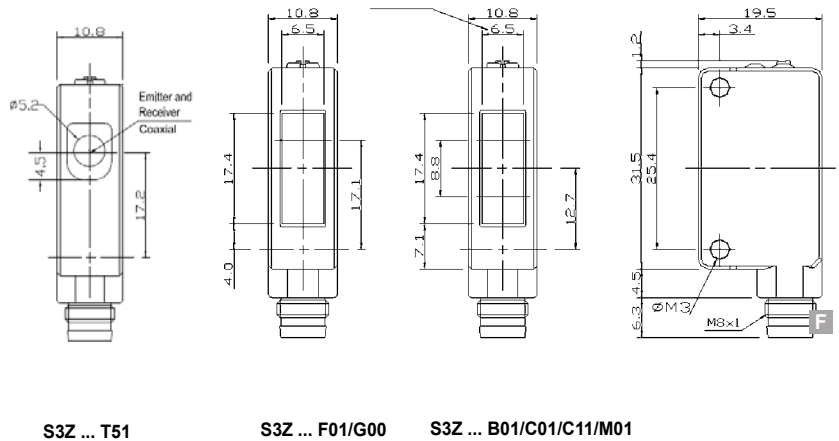

SLIT

Two different slit models, with rectangular or circular slot, can be easily mounted on the front side of the through beam sensors to reduce the emission beam. The resolution and the minimum object detectable can be improved with the slit positioned on the receiver (S3Z...F01). The installation of the two aligned sensor couples is eased by mounting the slit also on the emitter (S3Z...G00), avoiding reciprocal interference. The slit reduces the operating distance as shown in the following table.

Slit		Operating distance		Minimum object detectable (mm)	
Model	Width (mm)	Used on F01	Used on F01 and G00	Used on F01	Used on F01 and G00
S3Z-SLIT1	∅ 0.5	0.8	0.08	5	0.3
S3Z-SLIT2	∅ 1	1.5	0.3	5	0.6
S3Z-SLIT3	∅ 2	2.5	1.2	5	1.5
S3Z-SLIT4	0.5x18	2.5	1	7	0.5
S3Z-SLIT5	1x18	3.5	1.5	7	1
S3Z-SLIT6	2x18	6	3.5	7	2

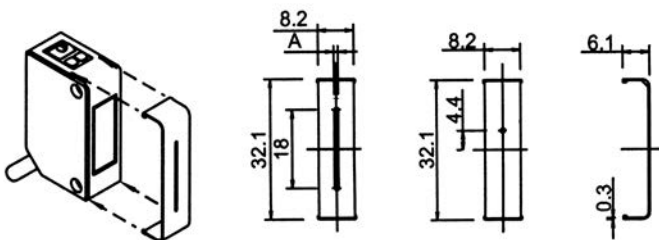

CONNECTIONS LED MODELS

S3Z ... B01/C01/C11/M01/T51

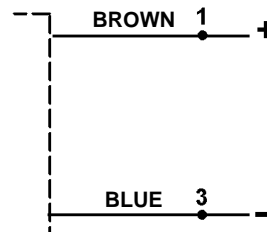
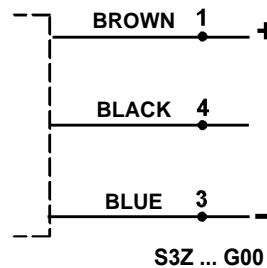

M8 CONNECTOR

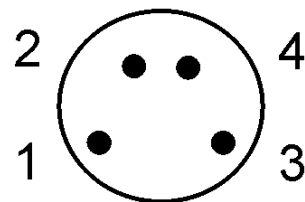

TECHNICAL DATA - BASIC LINE

TECHNICAL NOTES

¹Limit values

²Average life of 100.000 h with T_A=+25°C

³A - reverse polarity protection

B - overload and short-circuit protection (B01/C01/C11/F01 VERS.)

		S3Z-PR-2-B01	S3Z-PR-2-C01	S3Z-PR-2-C11	S3Z-PR-2-F01	S3Z-PR-2-G00	S3Z-PR-2-M01	S3Z-PR-2-T51	S3Z-PR-5-B01	S3Z-PR-5-C01	S3Z-PR-5-C11	S3Z-PR-5-F01	S3Z-PR-5-G00	S3Z-PR-5-M01	S3Z-PR-5-T51
Narrow beam proximity operating distance:	50 ... 150 mm		•						•						
Diffuse proximity operating distance:	0 ... 70 cm			•							•				
Polarized retroreflex operating distance:	0.05 ... 4 m (on R5)	•							•						
Polarized for transparent	0... 2 m (on R2)							•							•
Through beam operating distance:	0 ... 15 m				•	•							•	•	
Background suppression distance:	50 ... 300 mm						•								•
Power supply:	10 ... 30 Vdc ¹	•	•	•	•	•	•	•	•	•	•	•	•	•	•
Consumption:	30 mA max.	•	•	•	•	•	•	•	•	•	•	•	•	•	•
Light emission²:	red LED 665 nm	•	•				•	•	•	•				•	•
	infrared LED 870 nm			•		•					•		•		•
Setting:	sensitivity trimmer	•	•	•	•		•	•	•	•	•	•	•	•	•
Indicators:	yellow OUTPUT LED	•	•	•	•		•	•	•	•	•	•	•	•	•
	green STABILITY LED	•	•	•	•		•	•	•	•	•	•	•	•	•
	green POWER ON LED					•							•		
Output type:	PNP or NPN (refer to table)	•	•	•	•		•	•	•	•	•	•	•	•	•
Operating mode:	dark or light (refer to table)	•	•	•	•		•	•	•	•	•	•	•	•	•
Saturation voltage:	≤2 V	•	•	•	•		•	•	•	•	•	•	•	•	•
Response time:	1 ms			•	•		•	•	•	•	•	•	•	•	•
Switching frequency:	500 Hz	•	•	•	•	•	•	•	•	•	•	•	•	•	•
Output current:	≤100 mA	•	•	•	•		•	•	•	•	•	•	•	•	•
Connection:	2 m cable, Ø 3.5 mm	•	•	•	•	•	•	•	•	•	•	•	•	•	•
	4-pole M8 connector								•	•	•	•	•	•	•
Mechanical protection:	IP67	•	•	•	•	•	•	•	•	•	•	•	•	•	•
Protection devices:	A, B ³	•	•	•	•	•	•	•	•	•	•	•	•	•	•
Housing material:	PC / PBT	•	•	•	•	•	•	•	•	•	•	•	•	•	•
Lens material:	PMMA	•					•	•	•	•				•	•
	PC		•	•	•	•			•	•	•	•	•	•	•
Weight:	10 g								•	•	•	•	•	•	•
	50 g	•	•	•	•	•	•	•							
Operating temperature:	-25 ... +55°C	•	•	•	•	•	•	•	•	•	•	•	•	•	•
Storage temperature:	-25 ... +70°C	•	•	•	•	•	•	•	•	•	•	•	•	•	•
Standard reference:	EN 60947-5-2	•	•	•	•	•	•	•	•	•	•	•	•	•	•

DIAGRAMS LED MODELS

DETECTION AREA - BACKGROUND SUPPRESSION

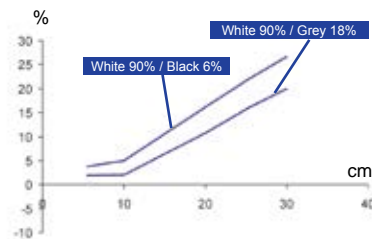

DETECTION AREA - DIFFUSE PROXIMITY

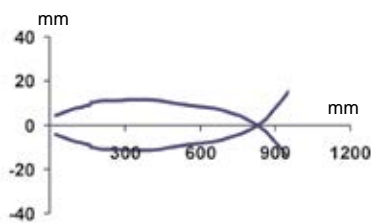

DETECTION AREA-NARROW BEAM PROXIMITY

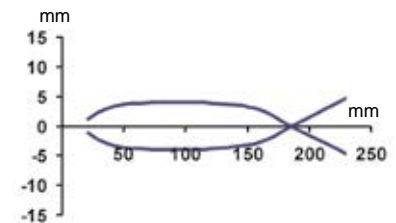

DETECTION AREA - POLARISED RETROREFLEX

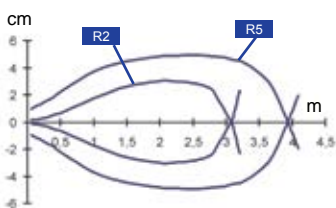

DETECTION AREA - THROUGH BEAM

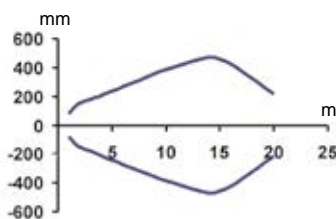

DETECTION AREA - FOR TRANSPARENT

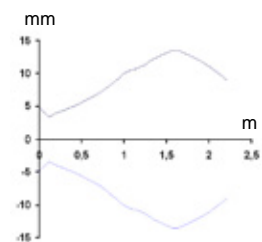

DIMENSION LASER MODELS

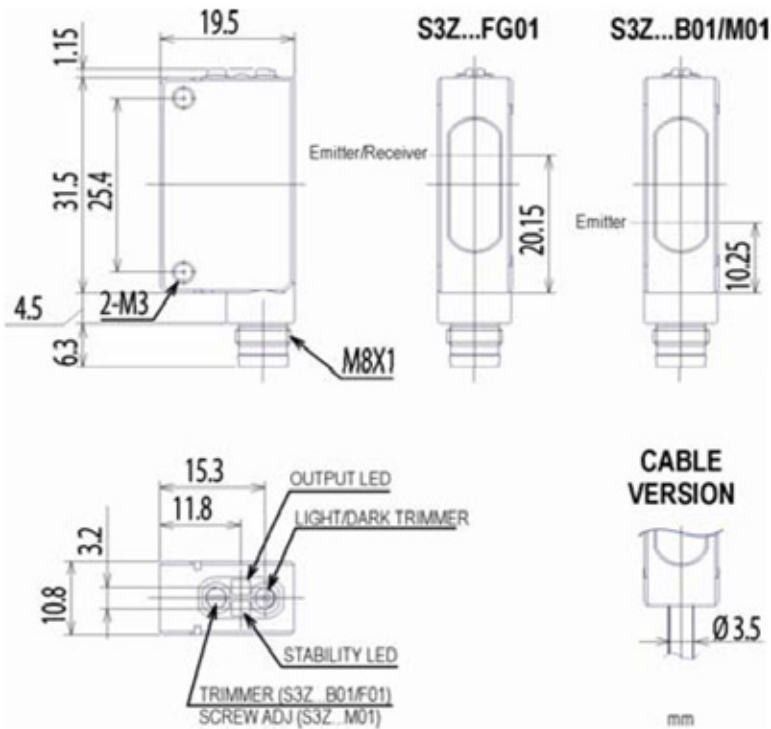

CONNECTIONS LASER MODELS

S3Z ... B01/M01/F01

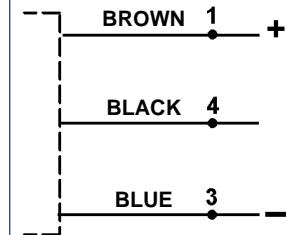

S3Z ... G00

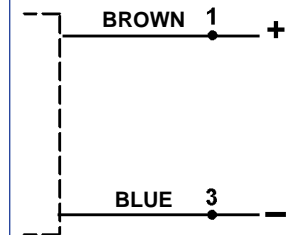

M8 CONNECTOR

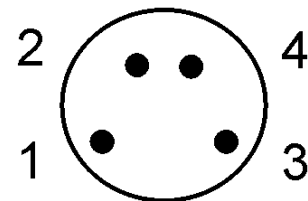

INSTALLATION

- Do not apply excessive impact on the sensor during the installation process, so as to prevent damage or deterioration in the degree of protection.
- To install the sensor, tighten the mounting screws to a torque of 0.5 Nm or less.
- Install the Background suppression type sensor head perpendicular to the object transfer as shown below to minimize sensing errors.

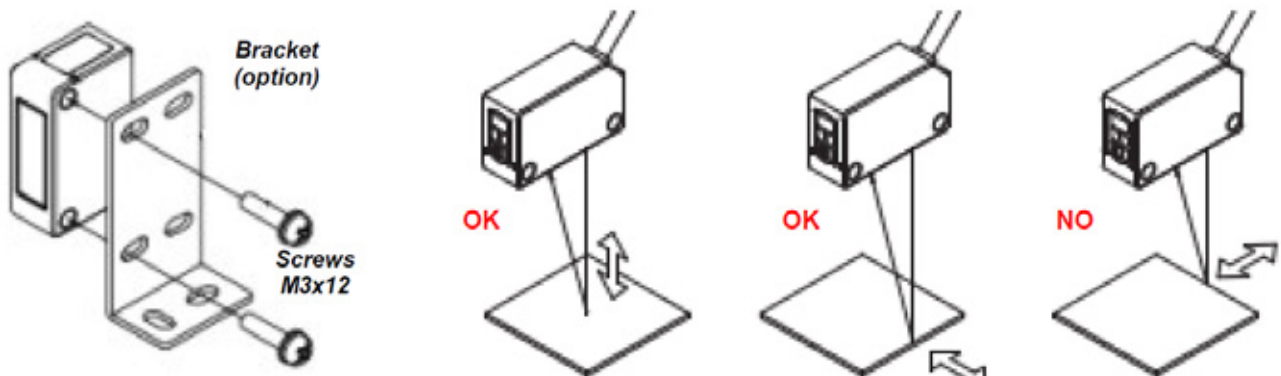

TECHNICAL DATA - LASER LINE

TECHNICAL NOTES		S3Z-PH-2-B01	S3Z-PH-2-F01	S3Z-PH-2-G00	S3Z-PH-2-M01	S3Z-PH-5-B01	S3Z-PH-5-F01	S3Z-PH-5-G00	S3Z-PH-5-M01
¹ Limit values									
² Class I CDRH 21 CFR PART 1040.10, max power ≤7 mW, 650 nm									
³ A - reverse polarity protection									
B - overload and short-circuit protection (B01/M01/F01 VERS.)									
Polarized retroreflex operating distance:	0.3 ... 10 m (on R2)	•				•			
Through beam operating distance:	0 ... 30 m		•	•			•	•	
Background suppression distance:	40 ... 300 mm				•				•
Background suppression grey/white difference:	10%				•				•
Spot dimension polarized:	Ø 5 mm, @ 3 m	•				•			
Spot dimension through beam:	Ø 5 mm, @ 3 m		•	•			•	•	
Spot dimension background:	Ø 0.5 mm, @ 170 mm				•				•
Power supply:	12 ... 24 Vdc ¹	•	•	•	•	•	•	•	•
Consumption:	35 mA max.	•	•	•	•	•	•	•	•
Light emission²:	red LASER class 1 EN 60825-1	•		•	•	•		•	•
Setting:	sensitivity trimmer	•	•		•	•	•		•
	D/L trimmer selection	•	•		•	•	•		•
Indicators:	yellow OUTPUT LED	•	•		•	•	•		•
	green STABILITY LED	•	•			•	•		
	green POWER ON LED			•				•	
Output type:	PNP or NPN (refer to table)	•	•	•	•	•	•	•	•
Operating mode:	dark or light (selectable by trimmer)	•	•	•	•	•	•	•	•
Saturation voltage:	≤1,5 V	•	•	•	•	•	•	•	•
Response time:	250 us	•	•	•	•	•	•	•	•
Switching frequency:	2 KHz	•	•	•	•	•	•	•	•
Output current:	≤100 mA	•	•	•	•	•	•	•	•
Connection:	2 m cable, Ø 3.5 mm	•	•	•	•				
	4-pole M8 connector					•	•	•	•
Mechnaical protection:	IP67	•	•	•	•	•	•	•	•
Protection devices:	A, B ³	•	•	•	•	•	•	•	•
Housing material:	PC (cover) / PBT (body)	•	•	•	•	•	•	•	•
Lens material:	PMMA	•	•	•	•	•	•	•	•
Weight:	10 g					•	•	•	•
	50 g	•	•	•	•				
Operating temperature:	-10 ... +55°C	•	•	•	•	•	•	•	•
Storage temperature:	-25 ... +70°C	•	•	•	•	•	•	•	•
Standard reference:	EN 60947-5-2	•	•	•	•	•	•	•	•

DIAGRAMS LASER MODELS

DETECTION AREA - BACKGROUND SUPPRESSION

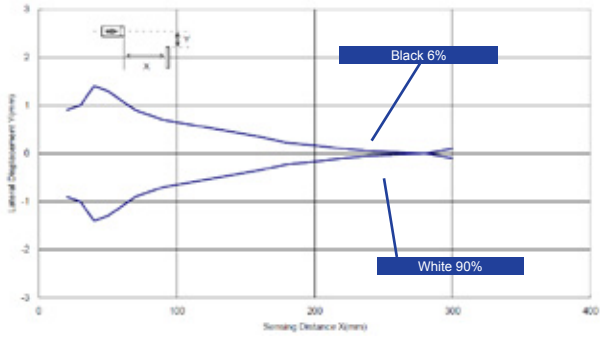

SPOT DIMENSION - BACKGROUND SUPPRESSION

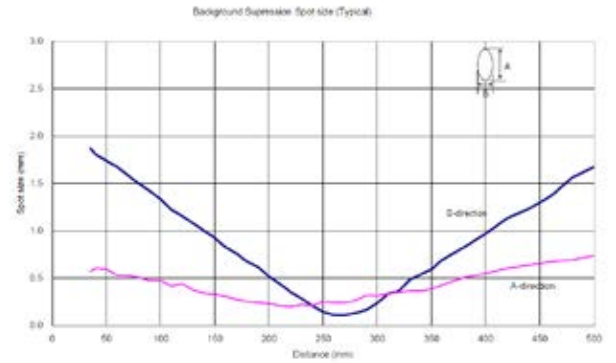

DETECTION AREA - POLARISED RETROREFLEX

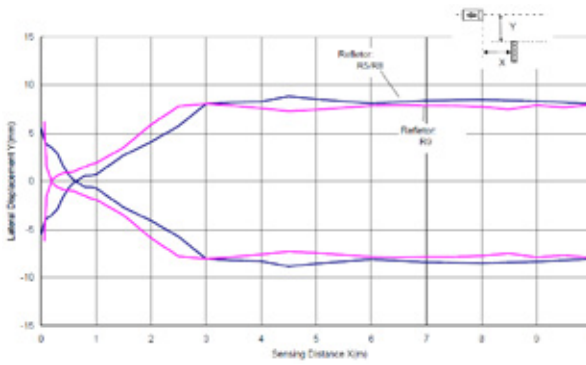

EXCESS GAIN - POLARISED RETROREFLEX

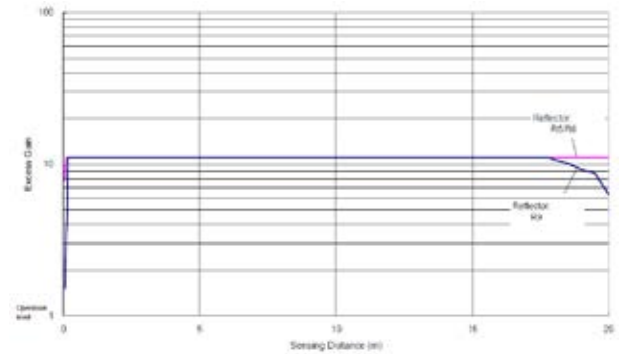

DETECTION AREA - THROUGH BEAM

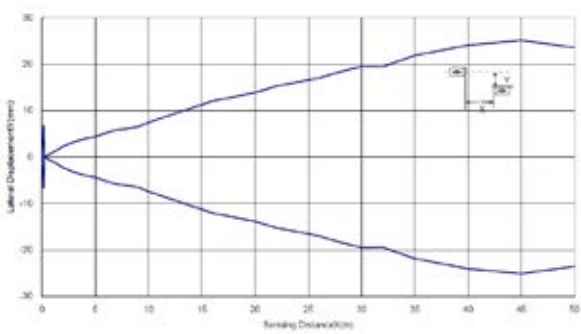

EXCESS GAIN - THROUGH BEAM

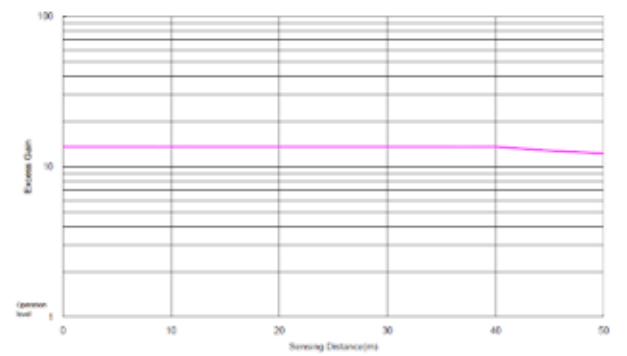

MODEL SELECTION TABLE

MODEL	FUNCTION	CONNECTION	OUTPUT	ORDER NO.
S3Z-PR-2-C01-PL	narrow beam	cable	PNP - light	95B010040
S3Z-PR-5-C01-PL	narrow beam	M8 connector	PNP - light	95B010050
S3Z-PR-2-C01-PD	narrow beam	cable	PNP - dark	95B010060
S3Z-PR-5-C01-PD	narrow beam	M8 connector	PNP - dark	95B010070
S3Z-PR-2-C01-NL	narrow beam	cable	NPN - light	95B010200
S3Z-PR-5-C01-NL	narrow beam	M8 connector	NPN - light	95B010210
S3Z-PR-2-C01-ND	narrow beam	cable	NPN - dark	95B010220
S3Z-PR-5-C01-ND	narrow beam	M8 connector	NPN - dark	95B010230
S3Z-PR-2-C11-PL	diffuse	cable	PNP - light	95B010000
S3Z-PR-5-C11-PL	diffuse	M8 connector	PNP - light	95B010010
S3Z-PR-2-C11-PD	diffuse	cable	PNP - dark	95B010020
S3Z-PR-5-C11-PD	diffuse	M8 connector	PNP - dark	95B010030
S3Z-PR-2-C11-NL	diffuse	cable	NPN - light	95B010160
S3Z-PR-5-C11-NL	diffuse	M8 connector	NPN - light	95B010170
S3Z-PR-2-C11-ND	diffuse	cable	NPN - dark	95B010180
S3Z-PR-5-C11-ND	diffuse	M8 connector	NPN - dark	95B010190
S3Z-PR-2-B01-PL	polarized retroreflex	cable	PNP - light	95B010080
S3Z-PR-5-B01-PL	polarized retroreflex	M8 connector	PNP - light	95B010090
S3Z-PR-2-B01-PD	polarized retroreflex	cable	PNP - dark	95B010100
S3Z-PR-5-B01-PD	polarized retroreflex	M8 connector	PNP - dark	95B010110
S3Z-PR-2-B01-NL	polarized retroreflex	cable	NPN - light	95B010240
S3Z-PR-5-B01-NL	polarized retroreflex	M8 connector	NPN - light	95B010250
S3Z-PR-2-B01-ND	polarized retroreflex	cable	NPN - dark	95B010260
S3Z-PR-5-B01-ND	polarized retroreflex	M8 connector	NPN - dark	95B010270
S3Z-PR-2-FG01-PL	through beam	cable	PNP - light	95B010120
S3Z-PR-5-FG01-PL	through beam	M8 connector	PNP - light	95B010130
S3Z-PR-2-FG01-PD	through beam	cable	PNP - dark	95B010140
S3Z-PR-5-FG01-PD	through beam	M8 connector	PNP - dark	95B010150
S3Z-PR-2-FG01-NL	through beam	cable	NPN - light	95B010280
S3Z-PR-5-FG01-NL	through beam	M8 connector	NPN - light	95B010290
S3Z-PR-2-FG01-ND	through beam	cable	NPN - dark	95B010300
S3Z-PR-5-FG01-ND	through beam	M8 connector	NPN - dark	95B010310
S3Z-PR-2-M01-PL	background suppression	cable	PNP - light	95B010330
S3Z-PR-5-M01-PL	background suppression	M8 connector	PNP - light	95B010350
S3Z-PR-2-M01-NL	background suppression	cable	NPN - light	95B010320
S3Z-PR-5-M01-NL	background suppression	M8 connector	NPN - light	95B010340
S3Z-PR-2-T51-ND	transparent polarized	cable	NPN - dark	95B010390
S3Z-PR-2-T51-PD	transparent polarized	cable	PNP - dark	95B010380
S3Z-PR-5-T51-ND	transparent polarized	M8 connector	NPN - dark	95B010370
S3Z-PR-5-T51-PD	transparent polarized	M8 connector	PNP - dark	95B010360
S3Z-PH-2-B01-PP	polarized laser	cable	PNP - dark/light	95B010440
S3Z-PH-5-B01-PP	polarized laser	M8 connector	PNP - dark/light	95B010460
S3Z-PH-2-B01-NN	polarized laser	cable	NPN - dark/light	95B010450
S3Z-PH-5-B01-NN	polarized laser	M8 connector	NPN - dark/light	95B010470
S3Z-PH-2-M01-PP	background suppression laser	cable	PNP - dark/light	95B010480
S3Z-PH-5-M01-PP	background suppression laser	M8 connector	PNP - dark/light	95B010500
S3Z-PH-2-M01-NN	background suppression laser	cable	NPN - dark/light	95B010490
S3Z-PH-5-M01-NN	background suppression laser	M8 connector	NPN - dark/light	95B010510
S3Z-PH-2-FG01-PP	through beam laser	cable	PNP - dark/light	95B010520
S3Z-PH-5-FG01-PP	through beam laser	M8 connector	PNP - dark/light	95B010540
S3Z-PH-2-FG01-NN	through beam laser	cable	NPN - dark/light	95B010530
S3Z-PH-5-FG01-NN	through beam laser	M8 connector	NPN - dark/light	95B010550

